

**Lucent Technologies**  
Bell Labs Innovations



# **DEFINITY® Enterprise Communications Server and System 75 and System 85**

Terminals and Adjuncts Reference

555-015-201  
Comcode 108603994  
Issue 11  
December 1999

## Notice

Every effort was made to ensure that the information in this book was complete and accurate at the time of printing. However, information is subject to change.

## Your Responsibility for Your System's Security

Toll fraud is the unauthorized use of your telecommunications system by an unauthorized party, for example, persons other than your company's employees, agents, subcontractors, or persons working on your company's behalf. Note that there may be a risk of toll fraud associated with your telecommunications system and, if toll fraud occurs, it can result in substantial additional charges for your telecommunications services.

You and your system manager are responsible for the security of your system, such as programming and configuring your equipment to prevent unauthorized use. The system manager is also responsible for reading all installation, instruction, and system administration documents provided with this product in order to fully understand the features that can introduce risk of toll fraud and the steps that can be taken to reduce that risk. Lucent Technologies does not warrant that this product is immune from or will prevent unauthorized use of common-carrier telecommunication services or facilities accessed through or connected to it. Lucent Technologies will not be responsible for any charges that result from such unauthorized use.

## Federal Communications Commission Statement

**Part 15: Class A Statement.** This equipment has been tested and found to comply with the limits for a Class A digital device, pursuant to Part 15 of the FCC Rules. These limits are designed to provide reasonable protection against harmful interference when the equipment is operated in a commercial environment. This equipment generates, uses, and can radiate radio-frequency energy and, if not installed and used in accordance with the instructions, may cause harmful interference to radio communications. Operation of this equipment in a residential area is likely to cause harmful interference, in which case the user will be required to correct the interference at his own expense.**Part 68: Network Registration Number.** This equipment is registered with the FCC in accordance with Part 68 of the FCC Rules. It is identified by FCC registration number xxx.

### Part 68: Answer-Supervision Signaling.

Allowing this equipment to be operated in a manner that does not provide proper answer-supervision signaling is in violation of Part 68 Rules. This equipment returns answer-supervision signals to the public switched network when:

- Answered by the called station
- Answered by the attendant
- Routed to a recorded announcement that can be administered by the CPE user

This equipment returns answer-supervision signals on all DID calls forwarded back to the public switched telephone network. Permissible exceptions are:

- A call is unanswered
- A busy tone is received

A reorder tone is received

## Canadian Department of Communications (DOC)

### Interference Information

This digital apparatus does not exceed the Class A limits for radio noise emissions set out in the radio interference regulations of the Canadian Department of Communications.

Le Présent Appareil Numérique n'émet pas de bruits radioélectriques dépassant les limites applicables aux appareils numériques de la class A prescrites dans le règlement sur le brouillage radioélectrique édicté par le ministère des Communications du Canada.

## Trademarks

5ESS, ACCUNET, AUDIX, CALLMASTER, CentreVu, DEFINITY, DIMENSION, MERLIN, PassageWay, SPOKESMAN, TERRA NOVA, and TransTalk are registered trademarks of Lucent Technologies. CARBON COPY Plus is a trademark of Microcom Systems Inc. E78 PLUS, CROSSTALK, and VT are registered trademarks of Digital Equipment Corporation.

HAYES is a registered trademark of Hayes Microcomputer Products, Inc. HYPERACCESS is a registered trademark of Hilgraeve Corporation. IBM is a registered trademark of International Business Machines Corporation. Micro Channel is a trademark of International Business Machines Corporation. PROCOMM PLUS is a registered trademark of Datastrom Technologies. ProLogix and TransTalk are trademarks of Lucent Technologies. RELAY GOLD is a registered trademark of Microcom Systems, Inc. SideKick is a registered trademark of Starfish Software, Inc. SMARTMODEM 2400 and SMARTCOM are trademarks of Hayes Microcomputer Products, Inc.

## Ordering Information

**Call:** Lucent Technologies BCS Publications Center  
Voice 1 800 457-1235 International Voice 317 322-6791  
Fax 1 800 457-1764 International Fax 317 322-6699

**Write:** Lucent Technologies BCS Publications Center  
2855 N. Franklin Road  
Indianapolis, IN 46219

**Order:** Document No. 555-015-201  
Issue 11, December 1999

You can be placed on a standing order list for this and other documents you may need. Standing order will enable you to automatically receive updated versions of individual documents or document sets, billed to account information that you provide. For more information on standing orders, or to be put on a list to receive future issues of this document, contact the Lucent Technologies BCS Publications Center. For more information about Lucent Technologies documents, refer to the *Business Communications Systems Publications Catalog*, 555-000-010.

## European Union Declaration of Conformity

Lucent Technologies Business Communications Systems declares that the equipment specified in this document conforms to the referenced European Union (EU) Directives and Harmonized Standards listed below:

EMC Directive	89/336/EEC
Low-Voltage Directive	73/23/EEC



The "CE" mark affixed to the equipment means that it conforms to the above directives.

## Disclaimer

Intellectual property related to this product and registered to AT&T Corporation has been transferred to Lucent Technologies Incorporated.

Any references within this text to American Telephone and Telegraph Corporation or AT&T should be interpreted as references to Lucent Technologies Incorporated. The exception is cross references to books published prior to December 31, 1996, which retain their original AT&T titles.

## Heritage

Lucent Technologies — formed as a result of AT&T's planned restructuring — designs, builds, and delivers a wide range of public and private networks, communication systems and software, consumer and business telephone systems, and microelectronics components. The world-renowned Bell Laboratories is the research and development arm for the company.

## Comments

To comment on this document, return the comment card at the front of the document.

## Acknowledgment

This document was prepared by Product Documentation Development, Lucent Technologies, Holmdel, NJ 07733-3030.

# Contents

<u><b>Contents</b></u>	<u><b>iii</b></u>
<u><b>1 Introduction</b></u>	<u><b>1-1</b></u>
■ <u>The Purpose of This Manual</u>	<u>1-1</u>
■ <u>The Organization of This Manual</u>	<u>1-4</u>
<u><b>2 General Information</b></u>	<u><b>2-1</b></u>
■ <u>Voice Terminals</u>	<u>2-1</u>
<u>Single-Line Voice Terminals</u>	<u>2-2</u>
<u>Multi-Appearance Voice Terminals</u>	<u>2-2</u>
<u>Facilities Common to All Voice Terminals</u>	<u>2-5</u>
<u>Buttons</u>	<u>2-5</u>
<u>Lights</u>	<u>2-8</u>
<u>Tones</u>	<u>2-10</u>
<u>Desk/Wall Mounting Arrangements</u>	<u>2-12</u>
■ <u>Adjuncts</u>	<u>2-12</u>
■ <u>Data Modules</u>	<u>2-15</u>
■ <u>PC Platform Products</u>	<u>2-18</u>
■ <u>Data Terminals</u>	<u>2-19</u>
■ <u>Technical Specifications</u>	<u>2-19</u>
<u>Call Progress Tones</u>	<u>2-19</u>
<u>External Ringing Tones</u>	<u>2-20</u>
<u>Indicator Lights Signals</u>	<u>2-21</u>
<u><b>3 Exposed Port Protection</b></u>	<u><b>3-1</b></u>
■ <u>Out-of-Building Campus Stations</u>	<u>3-1</u>
■ <u>Recommended Protectors and IROB Protection</u>	<u>3-3</u>
<u><b>4 Adjunct Power</b></u>	<u><b>4-1</b></u>
■ <u>Information on the Older Power Supplies</u>	<u>4-3</u>
<u>The Power Supplies Prior to the MSP-1</u>	<u>4-4</u>
<u>The MSP-1 Power Supply</u>	<u>4-5</u>
■ <u>The 1151A1 and 1151A2 Power Units</u>	<u>4-8</u>
<u>Contents of the 1151A1 and 1151A2 Packages (and Comcodes)</u>	<u>4-9</u>
<u>Connecting the Power Supply</u>	<u>4-10</u>

<b><u>5</u></b>	<b><u>Administration</u></b>	<b><u>5-1</u></b>
■	<u>Aliasing</u>	<u>5-2</u>
■	<u>Button and Feature Caveats</u>	<u>5-11</u>
	<u>System 75, DEFINITY G1 and G3,     and DEFINITY ECS</u>	<u>5-11</u>
	<u>System 85 and DEFINITY G2</u>	<u>5-12</u>
<b><u>6</u></b>	<b><u>Voice Terminal Features</u></b>	<b><u>6-1</u></b>
<b><u>7</u></b>	<b><u>The 6400 Series Telephones</u></b>	<b><u>7-1</u></b>
■	<u>The 6402 and 6402D Telephones</u>	<u>7-2</u>
	<u>Applications</u>	<u>7-4</u>
	<u>Physical Features</u>	<u>7-4</u>
	<u>Wiring Information</u>	<u>7-7</u>
	<u>Appropriate Circuit Packs and Distance     Limitations</u>	<u>7-8</u>
	<u>Power Requirements</u>	<u>7-8</u>
	<u>Administration</u>	<u>7-8</u>
	<u>Power Failure Operation</u>	<u>7-9</u>
	<u>FCC Registration</u>	<u>7-9</u>
	<u>UL and CSA Approval</u>	<u>7-9</u>
	<u>Hearing Aid Compatible</u>	<u>7-10</u>
	<u>6402 and 6402D Equipment PECs and     Comcodes</u>	<u>7-10</u>
	<u>Adjuncts</u>	<u>7-11</u>
	<u>Additional Documents</u>	<u>7-11</u>
■	<u>The 6408+ and 6408D+ Telephones</u>	<u>7-12</u>
	<u>Applications</u>	<u>7-14</u>
	<u>Physical Features</u>	<u>7-14</u>
	<u>Wiring Information</u>	<u>7-20</u>
	<u>Appropriate Circuit Packs and Distance     Limitations</u>	<u>7-21</u>
	<u>Power Requirements</u>	<u>7-21</u>
	<u>Administration</u>	<u>7-21</u>
	<u>Power Failure Operation</u>	<u>7-22</u>
	<u>FCC Registration</u>	<u>7-22</u>
	<u>UL and CSA Approval</u>	<u>7-23</u>

<a href="#">Hearing Aid Compatible</a>	<a href="#">7-23</a>
<a href="#">6408 Telephones and Equipment PECs and Comcodes</a>	<a href="#">7-23</a>
<a href="#">Adjuncts</a>	<a href="#">7-24</a>
<a href="#">Additional Documents</a>	<a href="#">7-24</a>
■ <a href="#">The 6416D+ and 6416D+M Telephones</a>	<a href="#">7-25</a>
<a href="#">All 6416D+ and 6416D+M Telephones</a>	<a href="#">7-25</a>
<a href="#">Only the Modular 6416D+M Telephone</a>	<a href="#">7-26</a>
<a href="#">Applications</a>	<a href="#">7-26</a>
<a href="#">Physical Features</a>	<a href="#">7-27</a>
<a href="#">Wiring Information</a>	<a href="#">7-33</a>
<a href="#">Appropriate Circuit Packs and Distance Limitations</a>	<a href="#">7-34</a>
<a href="#">Power Requirements</a>	<a href="#">7-34</a>
<a href="#">Administration</a>	<a href="#">7-35</a>
<a href="#">Power Failure Operation</a>	<a href="#">7-36</a>
<a href="#">FCC Registration</a>	<a href="#">7-36</a>
<a href="#">UL and CSA Approval</a>	<a href="#">7-36</a>
<a href="#">Hearing Aid Compatible</a>	<a href="#">7-36</a>
<a href="#">6416D+ and 6416D+M Telephones and Equipment PECs and Comcodes</a>	<a href="#">7-37</a>
<a href="#">Adjuncts</a>	<a href="#">7-38</a>
<a href="#">Additional Documents</a>	<a href="#">7-38</a>
■ <a href="#">The 6424D+ and 6424D+M Telephone</a>	<a href="#">7-39</a>
<a href="#">All 6424D+ and 6424D+M Telephones</a>	<a href="#">7-39</a>
<a href="#">Only the Modular 6424D+M</a>	<a href="#">7-40</a>
<a href="#">Applications</a>	<a href="#">7-40</a>
<a href="#">Physical Features</a>	<a href="#">7-41</a>
<a href="#">Wiring Information</a>	<a href="#">7-47</a>
<a href="#">Appropriate Circuit Packs and Distance Limitations</a>	<a href="#">7-48</a>
<a href="#">Power Requirements</a>	<a href="#">7-48</a>
<a href="#">Power Failure Operation</a>	<a href="#">7-50</a>
<a href="#">FCC Registration</a>	<a href="#">7-50</a>
<a href="#">UL and CSA Approval</a>	<a href="#">7-50</a>
<a href="#">Hearing Aid Compatible</a>	<a href="#">7-50</a>

[6424D+ and 6424D+M Equipment PECs  
and Comcodes](#) 7-51

[Adjuncts](#) 7-52

[Additional Documents](#) 7-52

**[8 The 7100 Series Voice Terminals](#) 8-1**

■ [The 7101A Voice Terminal](#) 8-2

[Applications](#) 8-3

[Physical Description](#) 8-3

[Distance Limitations](#) 8-5

[Power Requirements](#) 8-5

[Power Failure Operation](#) 8-5

[FCC Registration](#) 8-5

[Hearing Aid Compatible](#) 8-6

[7101A Equipment PECs](#) 8-6

[Adjuncts](#) 8-6

[Additional Documents](#) 8-6

■ [The 7102A and 7102 Plus Voice Terminals](#) 8-7

[Applications](#) 8-8

[Physical Description](#) 8-8

[Distance Limitations](#) 8-10

[Power Requirements](#) 8-10

[Power Failure Operation](#) 8-10

[FCC Registration](#) 8-10

[Hearing Aid Compatible](#) 8-11

[7102 Equipment PECs](#) 8-11

[Adjuncts](#) 8-11

[Additional Documents](#) 8-11

■ [The 7103A Fixed Feature Voice Terminal](#) 8-12

[Applications](#) 8-13

[Physical Description](#) 8-13

[Distance Limitations](#) 8-15

[Power Requirements](#) 8-15

[Power Failure Operation](#) 8-15

[FCC Registration](#) 8-15

[Hearing Aid Compatible](#) 8-16

<u>7103A (Fixed Feature) Equipment PECs</u>	<u>8-16</u>
<u>Adjuncts</u>	<u>8-16</u>
<u>Additional Documents</u>	<u>8-16</u>
■ <u>The 7103A Programmable Voice Terminal</u>	<u>8-17</u>
<u>Applications</u>	<u>8-18</u>
<u>Physical Description</u>	<u>8-18</u>
<u>Distance Limitations</u>	<u>8-20</u>
<u>Power Requirements</u>	<u>8-20</u>
<u>Power Failure Operation</u>	<u>8-20</u>
<u>FCC Registration</u>	<u>8-20</u>
<u>Hearing Aid Compatible</u>	<u>8-21</u>
<u>7103A (Programmable) Equipment PECs</u>	<u>8-21</u>
<u>Adjuncts</u>	<u>8-21</u>
<u>Additional Documents</u>	<u>8-21</u>
■ <u>The 7104A Voice Terminal</u>	<u>8-22</u>
<u>Applications</u>	<u>8-24</u>
<u>Physical Description</u>	<u>8-24</u>
<u>Distance Limitations</u>	<u>8-26</u>
<u>Power Requirements</u>	<u>8-26</u>
<u>Power Failure Operation</u>	<u>8-26</u>
<u>FCC Registration</u>	<u>8-27</u>
<u>Hearing Aid Compatible</u>	<u>8-27</u>
<u>7104A Equipment PECs</u>	<u>8-27</u>
<u>Adjuncts</u>	<u>8-27</u>
<u>Additional Documents</u>	<u>8-27</u>
<b><u>9 The 7200 Series Voice Terminals</u></b>	<b><u>9-1</u></b>
■ <u>The 7203H Voice Terminal</u>	<u>9-2</u>
<u>Applications</u>	<u>9-3</u>
<u>Physical Description</u>	<u>9-3</u>
<u>Distance Limitations</u>	<u>9-5</u>
<u>Power Requirements</u>	<u>9-5</u>
<u>Power Failure Operation</u>	<u>9-5</u>
<u>FCC Registration</u>	<u>9-5</u>
<u>Hearing Aid Compatible</u>	<u>9-5</u>
<u>7203H Equipment PECs</u>	<u>9-5</u>

<a href="#">Adjuncts</a>	<a href="#">9-6</a>
<a href="#">Additional Documents</a>	<a href="#">9-6</a>
■ <a href="#">The 7205H Voice Terminal</a>	<a href="#">9-7</a>
<a href="#">Applications</a>	<a href="#">9-8</a>
<a href="#">Physical Description</a>	<a href="#">9-8</a>
<a href="#">Distance Limitations</a>	<a href="#">9-10</a>
<a href="#">Power Requirements</a>	<a href="#">9-10</a>
<a href="#">Power Failure Operation</a>	<a href="#">9-10</a>
<a href="#">FCC Registration</a>	<a href="#">9-10</a>
<a href="#">Hearing Aid Compatible</a>	<a href="#">9-10</a>
<a href="#">7205H Equipment PECs</a>	<a href="#">9-11</a>
<a href="#">Adjuncts</a>	<a href="#">9-11</a>
<a href="#">Additional Documents</a>	<a href="#">9-11</a>

**10** [The 7300 Series Voice Terminals](#) [10-1](#)

■ <a href="#">The 7303S Voice Terminal</a>	<a href="#">10-2</a>
<a href="#">Applications</a>	<a href="#">10-3</a>
<a href="#">Physical Description</a>	<a href="#">10-3</a>
<a href="#">Distance Limitations</a>	<a href="#">10-5</a>
<a href="#">Power Requirements</a>	<a href="#">10-5</a>
<a href="#">Power Failure Operation</a>	<a href="#">10-5</a>
<a href="#">FCC Registration</a>	<a href="#">10-5</a>
<a href="#">Hearing Aid Compatible</a>	<a href="#">10-6</a>
<a href="#">7303S Equipment PECs</a>	<a href="#">10-6</a>
<a href="#">Adjuncts</a>	<a href="#">10-6</a>
<a href="#">Additional Documents</a>	<a href="#">10-6</a>
■ <a href="#">The 7305S Voice Terminal</a>	<a href="#">10-7</a>
<a href="#">Applications</a>	<a href="#">10-8</a>
<a href="#">Physical Description</a>	<a href="#">10-8</a>
<a href="#">Distance Limitations</a>	<a href="#">10-10</a>
<a href="#">Power Requirements</a>	<a href="#">10-10</a>
<a href="#">Power Failure Operation</a>	<a href="#">10-10</a>
<a href="#">FCC Registration</a>	<a href="#">10-10</a>
<a href="#">Hearing Aid Compatible</a>	<a href="#">10-11</a>
<a href="#">7305S Equipment PECs</a>	<a href="#">10-11</a>
<a href="#">Adjuncts</a>	<a href="#">10-11</a>



[Additional Documents](#) 10-11

**11 [The 7400 Series Voice Terminals](#) 11-1**

■ [The 7401D and 7401 Plus Voice Terminals](#) 11-2

[Applications](#) 11-3

[Special Operational Characteristics](#) 11-3

[Physical Features](#) 11-4

[Distance Limitations](#) 11-7

[Power Requirements](#) 11-7

[Switch Administration](#) 11-8

[Power Failure Operation](#) 11-11

[FCC Registration](#) 11-12

[UL and CSA Approval](#) 11-12

[Hearing Aid Compatible](#) 11-12

[7401D Equipment PECs and Comcodes](#) 11-12

[7401 Plus Equipment with PECs and Comcodes](#) 11-13

[Adjuncts](#) 11-14

[Additional Documents](#) 11-15

■ [The 7402 Plus Voice Terminal](#) 11-16

[Applications](#) 11-17

[Physical Features](#) 11-17

[Distance Limitations](#) 11-20

[Power Requirements](#) 11-20

[Switch Administration](#) 11-21

[Power Failure Operation](#) 11-23

[FCC Registration](#) 11-24

[UL and CSA Approval](#) 11-24

[Hearing Aid Compatible](#) 11-24

[7402 Plus Equipment PECs and Comcodes](#) 11-24

[Adjuncts](#) 11-25

[Additional Documents](#) 11-26

■ [The 7403D Voice Terminal](#) 11-27

[Applications](#) 11-28

[Physical Description](#) 11-28

[Distance Limitations](#) 11-30

<a href="#">Power Requirements</a>	11-30
<a href="#">Power Failure Operation</a>	11-30
<a href="#">FCC Registration</a>	11-30
<a href="#">Hearing Aid Compatible</a>	11-30
<a href="#">7403D Equipment PECs</a>	11-31
<a href="#">Adjuncts</a>	11-31
<a href="#">Additional Documents</a>	11-31
■ <a href="#">The 7404D Voice Terminal</a>	11-32
<a href="#">Applications</a>	11-33
<a href="#">Physical Description</a>	11-33
<a href="#">Distance Limitations</a>	11-35
<a href="#">Power Requirements</a>	11-35
<a href="#">Power Failure Operation</a>	11-35
<a href="#">FCC Registration</a>	11-35
<a href="#">Hearing Aid Compatible</a>	11-35
<a href="#">7404D Equipment PECs</a>	11-36
<a href="#">Adjuncts</a>	11-36
<a href="#">Additional Documents</a>	11-36
■ <a href="#">The 7405D Voice Terminal</a>	11-37
<a href="#">Applications</a>	11-38
<a href="#">Physical Description</a>	11-38
<a href="#">Distance Limitations</a>	11-40
<a href="#">Power Requirements</a>	11-40
<a href="#">Power Failure Operation</a>	11-40
<a href="#">FCC Registration</a>	11-40
<a href="#">Hearing Aid Compatible</a>	11-41
<a href="#">7405D Equipment PECs</a>	11-41
<a href="#">Adjuncts</a>	11-41
<a href="#">Additional Documents</a>	11-41
■ <a href="#">The 7406D, 7406BIS, and 7406 Plus Voice Terminals</a>	11-42
<a href="#">Applications</a>	11-46
<a href="#">Physical Description</a>	11-46
<a href="#">Distance Limitations</a>	11-51
<a href="#">Power Requirements</a>	11-52
<a href="#">Switch Administration</a>	11-52

<a href="#">Power Failure Operation</a>	11-58
<a href="#">FCC Registration</a>	11-58
<a href="#">UL and CSA Approval</a>	11-58
<a href="#">Hearing Aid Compatibility</a>	11-58
<a href="#">7406D/7406BIS Equipment PECs and Comcodes</a>	11-58
<a href="#">7406 Plus Equipment PECs and Comcodes</a>	11-60
<a href="#">Adjuncts</a>	11-61
<a href="#">Additional Documents</a>	11-61
■ <a href="#">The 7407D, Enhanced 7407D, and 7407 Plus Voice Terminals</a>	11-63
<a href="#">Applications</a>	11-67
<a href="#">Special Operational Characteristics</a>	11-67
<a href="#">Physical Features</a>	11-70
<a href="#">Distance Limitations</a>	11-76
<a href="#">Power Requirements</a>	11-76
<a href="#">Switch Administration</a>	11-77
<a href="#">Power Failure Operation</a>	11-83
<a href="#">FCC Registration</a>	11-83
<a href="#">UL and CSA Approval</a>	11-84
<a href="#">Hearing Aid Compatible</a>	11-84
<a href="#">7407D/Enhanced 7407D Equipment PECs and Comcodes</a>	11-84
<a href="#">7407 Plus Equipment PECs and Comcodes</a>	11-85
<a href="#">Adjuncts</a>	11-86
<a href="#">Additional Documents</a>	11-87
■ <a href="#">The 7410D and 7410 Plus Voice Terminals</a>	11-88
<a href="#">Applications</a>	11-90
<a href="#">Physical Description</a>	11-90
<a href="#">Distance Limitations</a>	11-93
<a href="#">Power Requirements</a>	11-93
<a href="#">Switch Administration</a>	11-94
<a href="#">Power Failure Operation</a>	11-99
<a href="#">FCC Registration</a>	11-99
<a href="#">UL and CSA Approval</a>	11-99
<a href="#">Hearing Aid Compatible</a>	11-99

<a href="#">7410D Equipment with PECs and Comcodes</a>	<a href="#">11-99</a>
<a href="#">7410 Plus Equipment PECs and Comcodes</a>	<a href="#">11-100</a>
<a href="#">Adjuncts</a>	<a href="#">11-101</a>
<a href="#">Additional Documents</a>	<a href="#">11-101</a>
■ <a href="#">The 7434D Voice Terminal</a>	<a href="#">11-102</a>
<a href="#">Applications</a>	<a href="#">11-103</a>
<a href="#">Physical Description</a>	<a href="#">11-103</a>
<a href="#">Distance Limitations</a>	<a href="#">11-105</a>
<a href="#">Power Requirements</a>	<a href="#">11-106</a>
<a href="#">Power Failure Operation</a>	<a href="#">11-106</a>
<a href="#">FCC Registration</a>	<a href="#">11-106</a>
<a href="#">Hearing Aid Compatible</a>	<a href="#">11-106</a>
<a href="#">7434 Equipment PECs</a>	<a href="#">11-106</a>
<a href="#">Adjuncts</a>	<a href="#">11-107</a>
<a href="#">Additional Documents</a>	<a href="#">11-107</a>
■ <a href="#">The 7444 Voice Terminal</a>	<a href="#">11-108</a>
<a href="#">Applications</a>	<a href="#">11-109</a>
<a href="#">Physical Description</a>	<a href="#">11-110</a>
<a href="#">Distance Limitations</a>	<a href="#">11-113</a>
<a href="#">Power Requirements</a>	<a href="#">11-114</a>
<a href="#">Switch Administration</a>	<a href="#">11-114</a>
<a href="#">Power Failure Operation</a>	<a href="#">11-118</a>
<a href="#">FCC Registration</a>	<a href="#">11-118</a>
<a href="#">UL and CSA Approval</a>	<a href="#">11-118</a>
<a href="#">Hearing Aid Compatible</a>	<a href="#">11-118</a>
<a href="#">7444 Equipment PECs and Comcodes</a>	<a href="#">11-118</a>
<a href="#">Adjuncts</a>	<a href="#">11-119</a>
<a href="#">Additional Documents</a>	<a href="#">11-119</a>

**12 The 8400 Series Voice Terminals** [12-1](#)

■ <a href="#">The 8403 Voice Terminal</a>	<a href="#">12-2</a>
<a href="#">Applications</a>	<a href="#">12-3</a>
<a href="#">Physical Features</a>	<a href="#">12-4</a>
<a href="#">Wiring Information</a>	<a href="#">12-6</a>
<a href="#">Distance Limitations</a>	<a href="#">12-8</a>
<a href="#">Power Requirements</a>	<a href="#">12-8</a>

<a href="#">Switch Administration</a>	12-9
<a href="#">Power Failure Operation</a>	12-11
<a href="#">FCC Registration</a>	12-12
<a href="#">UL and CSA Approval</a>	12-12
<a href="#">Hearing Aid Compatible</a>	12-12
<a href="#">8403 Equipment PECs and Comcodes</a>	12-12
<a href="#">Adjuncts</a>	12-13
<a href="#">Additional Documents</a>	12-13
■ <a href="#">The 8405B, 8405B Plus, 8405D, and 8405D Plus Voice Terminals</a>	12-14
<a href="#">Applications</a>	12-18
<a href="#">Physical Features</a>	12-18
<a href="#">Wiring Information</a>	12-25
<a href="#">Distance Limitations</a>	12-26
<a href="#">Power Requirements</a>	12-26
<a href="#">Switch Administration</a>	12-27
<a href="#">Power Failure Operation</a>	12-30
<a href="#">FCC Registration</a>	12-30
<a href="#">UL and CSA Approval</a>	12-31
<a href="#">Hearing Aid Compatible</a>	12-31
<a href="#">8405 Equipment PECs and Comcodes</a>	12-31
<a href="#">Adjuncts</a>	12-32
<a href="#">Additional Documents</a>	12-33
■ <a href="#">The 8410 Voice Terminal</a>	12-34
<a href="#">Applications</a>	12-36
<a href="#">Physical Features</a>	12-36
<a href="#">Wiring Information</a>	12-43
<a href="#">Distance Limitations</a>	12-44
<a href="#">Power Requirements</a>	12-44
<a href="#">Switch Administration</a>	12-45
<a href="#">Power Failure Operation</a>	12-48
<a href="#">FCC Registration</a>	12-48
<a href="#">UL and CSA Approval</a>	12-49
<a href="#">Hearing Aid Compatible</a>	12-49
<a href="#">8410 Equipment PECs and Comcodes</a>	12-49
<a href="#">Adjuncts</a>	12-50

[Additional Documents](#) 12-50

■ [The 8411 Voice Terminal](#) 12-51

[Applications](#) 12-52

[Physical Features](#) 12-53

[Wiring Information](#) 12-63

[Distance Limitations](#) 12-64

[Power Requirements](#) 12-64

[Switch Administration](#) 12-65

[Power Failure Operation](#) 12-69

[FCC Registration](#) 12-69

[UL and CSA Approval](#) 12-69

[Hearing Aid Compatible](#) 12-69

[8411 Equipment PECs and Comcodes](#) 12-69

[Adjuncts](#) 12-70

[Additional Documents](#) 12-71

■ [The 8434 and 8434DX Voice Terminals](#) 12-72

[Applications](#) 12-75

[Physical Description](#) 12-75

[Wiring Information](#) 12-83

[Distance Limitations](#) 12-84

[Power Requirements](#) 12-84

[Switch Administration](#) 12-85

[Power Failure Operation](#) 12-88

[FCC Registration](#) 12-89

[UL and CSA Approval](#) 12-89

[Hearing Aid Compatible](#) 12-89

[8434 and 8434DX Equipment PECs and Comcodes](#) 12-89

[Adjuncts](#) 12-90

[Additional Documents](#) 12-91

**13** [CALLMASTER Voice Terminals](#) 13-1

■ [The CALLMASTER, CALLMASTER II, CALLMASTER III, CALLMASTER IV, CALLMASTER V, and CALLMASTER VI Voice Terminals](#) 13-2

[Applications](#) 13-8

<a href="#">Special Operational Characteristics</a>	<a href="#">13-9</a>
<a href="#">Physical Description</a>	<a href="#">13-9</a>
<a href="#">Wiring Information on the CALLMASTER IV</a>	<a href="#">13-15</a>
<a href="#">Wiring Note for the CALLMASTER VI</a>	<a href="#">13-16</a>
<a href="#">Distance Limitations</a>	<a href="#">13-16</a>
<a href="#">Power Requirements</a>	<a href="#">13-17</a>
<a href="#">Switch Administration</a>	<a href="#">13-17</a>
<a href="#">Power Failure Operation</a>	<a href="#">13-24</a>
<a href="#">FCC Registration</a>	<a href="#">13-24</a>
<a href="#">CALLMASTER Equipment PECs and Comcodes</a>	<a href="#">13-25</a>
<a href="#">Adjuncts</a>	<a href="#">13-26</a>
<a href="#">Additional Documents</a>	<a href="#">13-27</a>

**[14 The 500 and 2500 Series Telephones](#)** [14-1](#)

■ <a href="#">The 500 Series Telephone</a>	<a href="#">14-2</a>
<a href="#">Applications</a>	<a href="#">14-2</a>
<a href="#">Physical Description</a>	<a href="#">14-3</a>
<a href="#">Distance Limitations</a>	<a href="#">14-4</a>
<a href="#">Power Requirements</a>	<a href="#">14-4</a>
<a href="#">Power Failure Operation</a>	<a href="#">14-4</a>
<a href="#">FCC Registration</a>	<a href="#">14-4</a>
<a href="#">500-Series Telephone Equipment PECs</a>	<a href="#">14-5</a>
<a href="#">Adjuncts</a>	<a href="#">14-5</a>
<a href="#">Additional Documents</a>	<a href="#">14-5</a>
■ <a href="#">The 2500 Series Telephones</a>	<a href="#">14-6</a>
<a href="#">Applications</a>	<a href="#">14-8</a>
<a href="#">Physical Description</a>	<a href="#">14-9</a>
<a href="#">Distance Limitations</a>	<a href="#">14-10</a>
<a href="#">Power Requirements</a>	<a href="#">14-11</a>
<a href="#">Power Failure Operation</a>	<a href="#">14-11</a>
<a href="#">FCC Registration</a>	<a href="#">14-11</a>
<a href="#">2500-Series Telephone Equipment PECs</a>	<a href="#">14-11</a>
<a href="#">Adjuncts</a>	<a href="#">14-12</a>
■ <a href="#">The 2500 DMGC Telephone</a>	<a href="#">14-13</a>
<a href="#">Applications</a>	<a href="#">14-13</a>

<u>Physical Description</u>	<u>14-14</u>
<u>Distance Limitations</u>	<u>14-15</u>
<u>Power Requirements</u>	<u>14-15</u>
<u>Power Failure Operation</u>	<u>14-15</u>
<u>FCC Registration</u>	<u>14-15</u>
<u>2500 DMGC Equipment PECs</u>	<u>14-16</u>
<u>Adjuncts</u>	<u>14-16</u>
<u>Additional Documents</u>	<u>14-16</u>
■ <u>The 2500 YMGK Telephone</u>	<u>14-17</u>
<u>Applications</u>	<u>14-17</u>
<u>Physical Description</u>	<u>14-18</u>
<u>Distance Limitations</u>	<u>14-19</u>
<u>Power Requirements</u>	<u>14-19</u>
<u>Power Failure Operation</u>	<u>14-20</u>
<u>FCC Registration</u>	<u>14-20</u>
<u>2500 YMGK Equipment PECs</u>	<u>14-20</u>
<u>Adjuncts</u>	<u>14-20</u>
<u>Additional Documents</u>	<u>14-20</u>
■ <u>The 2500 MMGL and 2500 YMGL,          2500 MMGM and 2500 YMGM, and 2554          MMGM and 2554 YMGM Telephones</u>	<u>14-21</u>
<u>Applications</u>	<u>14-24</u>
<u>Physical Description</u>	<u>14-24</u>
<u>Distance Limitations</u>	<u>14-26</u>
<u>Power Requirements</u>	<u>14-27</u>
<u>Switch Administration</u>	<u>14-27</u>
<u>Power Failure Operation</u>	<u>14-27</u>
<u>FCC Registration</u>	<u>14-27</u>
<u>UL and CSA Approval</u>	<u>14-27</u>
<u>Hearing Aid Compatible</u>	<u>14-27</u>
<u>2500 MMGL and 2500 YMGL Equipment PECs</u>	<u>14-28</u>
<u>Additional Documents</u>	<u>14-28</u>
■ <u>The 2500 MMGN and 2500 YMGP and          2554 MMGN and 2554 YMGP Telephones</u>	<u>14-29</u>
<u>Applications</u>	<u>14-31</u>
<u>Physical Description</u>	<u>14-31</u>



<a href="#">Distance Limitations</a>	<a href="#">14-33</a>
<a href="#">Power Requirements</a>	<a href="#">14-33</a>
<a href="#">Switch Administration</a>	<a href="#">14-34</a>
<a href="#">Power Failure Operation</a>	<a href="#">14-34</a>
<a href="#">FCC Registration</a>	<a href="#">14-34</a>
<a href="#">UL and CSA Approval</a>	<a href="#">14-34</a>
<a href="#">Hearing Aid Compatible</a>	<a href="#">14-34</a>
<a href="#">2500 MMGN and 2500 YMGP Equipment PECs</a>	<a href="#">14-35</a>
<a href="#">Additional Documents</a>	<a href="#">14-35</a>

**15 [The 6200 Series Telephones](#) [15-1](#)**

■ <a href="#">The 6210 Telephone</a>	<a href="#">15-2</a>
<a href="#">Applications</a>	<a href="#">15-3</a>
<a href="#">Physical Description</a>	<a href="#">15-3</a>
<a href="#">Distance Limitations</a>	<a href="#">15-5</a>
<a href="#">Power Requirements</a>	<a href="#">15-5</a>
<a href="#">Switch Administration</a>	<a href="#">15-5</a>
<a href="#">Power Failure Operation</a>	<a href="#">15-5</a>
<a href="#">Ringer Equivalency Numbers</a>	<a href="#">15-6</a>
<a href="#">FCC Registration</a>	<a href="#">15-6</a>
<a href="#">Hearing Aid Compatible</a>	<a href="#">15-6</a>
<a href="#">6210 Telephone PECs and Comcodes</a>	<a href="#">15-6</a>
<a href="#">Adjuncts</a>	<a href="#">15-6</a>
<a href="#">Additional Documents</a>	<a href="#">15-7</a>
■ <a href="#">The 6218 and 6220 Telephones</a>	<a href="#">15-8</a>
<a href="#">Applications</a>	<a href="#">15-9</a>
<a href="#">Physical Description</a>	<a href="#">15-10</a>
<a href="#">Distance Limitations</a>	<a href="#">15-12</a>
<a href="#">Power Requirements</a>	<a href="#">15-12</a>
<a href="#">Switch Administration</a>	<a href="#">15-13</a>
<a href="#">Power Failure Operation</a>	<a href="#">15-13</a>
<a href="#">Ringer Equivalency Numbers</a>	<a href="#">15-13</a>
<a href="#">FCC Registration</a>	<a href="#">15-13</a>
<a href="#">Hearing Aid Compatible</a>	<a href="#">15-13</a>
<a href="#">6218 and 6220 Telephones PECs and Comcodes</a>	<a href="#">15-13</a>

[Adjuncts](#) 15-14

[Additional Documents](#) 15-14

**16 [The 8100 Series Telephones](#) 16-1**

■ [The 8101 and 8101M Telephones](#) 16-2

[Applications](#) 16-4

[Physical Description](#) 16-4

[Distance Limitations](#) 16-6

[Power Requirements](#) 16-6

[Switch Administration](#) 16-6

[Power Failure Operation](#) 16-6

[Ringer Equivalency Numbers](#) 16-7

[FCC Registration](#) 16-7

[Hearing Aid Compatible](#) 16-7

[8101 and 8101M Telephones PECs and Comcodes](#) 16-7

[Adjuncts](#) 16-8

[Additional Documents](#) 16-8

■ [The 8102 and 8102M Telephones](#) 16-9

[Applications](#) 16-10

[Physical Description](#) 16-10

[Distance Limitations](#) 16-13

[Power Requirements](#) 16-13

[Switch Administration](#) 16-13

[Administration of Hidden Features](#) 16-14

[Power Failure Operation](#) 16-14

[Ringer Equivalency Numbers](#) 16-14

[FCC Registration](#) 16-14

[Hearing Aid Compatible](#) 16-14

[8102 and 8102M Telephones PECs and Comcodes](#) 16-14

[Adjuncts](#) 16-16

[Additional Documents](#) 16-16

■ [The 8110 and 8110M Telephones](#) 16-17

[Applications](#) 16-18

[Physical Description](#) 16-18

[Distance Limitations](#) 16-21

<a href="#">Power Requirements</a>	<a href="#">16-22</a>
<a href="#">Switch Administration</a>	<a href="#">16-23</a>
<a href="#">Administration of Hidden Features</a>	<a href="#">16-23</a>
<a href="#">Power Failure Operation</a>	<a href="#">16-23</a>
<a href="#">Ringer Equivalency Numbers</a>	<a href="#">16-23</a>
<a href="#">FCC Registration</a>	<a href="#">16-23</a>
<a href="#">Hearing Aid Compatible</a>	<a href="#">16-23</a>
<a href="#">8110 and 8110M Telephones Equipment PECs and Comcodes</a>	<a href="#">16-24</a>
<a href="#">Adjuncts</a>	<a href="#">16-25</a>
<a href="#">Additional Documents</a>	<a href="#">16-26</a>

**[17 ISDN Voice Terminals](#)** [17-1](#)

■ <a href="#">The ISDN 7505 Modular Terminal</a>	<a href="#">17-2</a>
<a href="#">Applications</a>	<a href="#">17-3</a>
<a href="#">Physical Description</a>	<a href="#">17-3</a>
<a href="#">Distance Limitations</a>	<a href="#">17-5</a>
<a href="#">Power Requirements</a>	<a href="#">17-6</a>
<a href="#">Terminating Resistor</a>	<a href="#">17-6</a>
<a href="#">Power Failure Operation</a>	<a href="#">17-6</a>
<a href="#">FCC Registration</a>	<a href="#">17-6</a>
<a href="#">Hearing Aid Compatible</a>	<a href="#">17-6</a>
<a href="#">7505 Equipment PECs</a>	<a href="#">17-6</a>
<a href="#">Adjuncts</a>	<a href="#">17-7</a>
<a href="#">Additional Documents</a>	<a href="#">17-7</a>
■ <a href="#">The ISDN 7506 Voice Terminal</a>	<a href="#">17-8</a>
<a href="#">Applications</a>	<a href="#">17-9</a>
<a href="#">Physical Description</a>	<a href="#">17-9</a>
<a href="#">Distance Limitations</a>	<a href="#">17-12</a>
<a href="#">Power Requirements</a>	<a href="#">17-12</a>
<a href="#">Terminating Resistor</a>	<a href="#">17-12</a>
<a href="#">Power Failure Operation</a>	<a href="#">17-12</a>
<a href="#">FCC Registration</a>	<a href="#">17-12</a>
<a href="#">Hearing Aid Compatible</a>	<a href="#">17-12</a>
<a href="#">7506 Equipment PECs</a>	<a href="#">17-13</a>
<a href="#">Adjuncts</a>	<a href="#">17-13</a>

<a href="#"><u>Additional Documents</u></a>	<a href="#"><u>17-13</u></a>
■ <a href="#"><u>The ISDN 7507 Display Terminal</u></a>	<a href="#"><u>17-14</u></a>
<a href="#"><u>Applications</u></a>	<a href="#"><u>17-15</u></a>
<a href="#"><u>Physical Description</u></a>	<a href="#"><u>17-15</u></a>
<a href="#"><u>Distance Limitations</u></a>	<a href="#"><u>17-18</u></a>
<a href="#"><u>Power Requirements</u></a>	<a href="#"><u>17-18</u></a>
<a href="#"><u>Terminating Resistor</u></a>	<a href="#"><u>17-18</u></a>
<a href="#"><u>Power Failure Operation</u></a>	<a href="#"><u>17-18</u></a>
<a href="#"><u>FCC Registration</u></a>	<a href="#"><u>17-18</u></a>
<a href="#"><u>Hearing Aid Compatible</u></a>	<a href="#"><u>17-18</u></a>
<a href="#"><u>7507 Equipment PECs</u></a>	<a href="#"><u>17-19</u></a>
<a href="#"><u>Adjuncts</u></a>	<a href="#"><u>17-19</u></a>
<a href="#"><u>Additional Documents</u></a>	<a href="#"><u>17-19</u></a>
■ <a href="#"><u>The ISDN 8503 Voice Terminal</u></a>	<a href="#"><u>17-20</u></a>
<a href="#"><u>Applications</u></a>	<a href="#"><u>17-21</u></a>
<a href="#"><u>Physical Description</u></a>	<a href="#"><u>17-21</u></a>
<a href="#"><u>Distance Limitations</u></a>	<a href="#"><u>17-25</u></a>
<a href="#"><u>Power Requirements</u></a>	<a href="#"><u>17-25</u></a>
<a href="#"><u>Switch Administration</u></a>	<a href="#"><u>17-26</u></a>
<a href="#"><u>Power Failure Operation</u></a>	<a href="#"><u>17-26</u></a>
<a href="#"><u>FCC Registration</u></a>	<a href="#"><u>17-26</u></a>
<a href="#"><u>Hearing Aid Compatible</u></a>	<a href="#"><u>17-27</u></a>
<a href="#"><u>8503T Equipment PECs and Comcodes</u></a>	<a href="#"><u>17-27</u></a>
<a href="#"><u>Adjuncts</u></a>	<a href="#"><u>17-27</u></a>
<a href="#"><u>Additional Documents</u></a>	<a href="#"><u>17-28</u></a>
■ <a href="#"><u>The ISDN 8510 Voice/Data Terminal</u></a>	<a href="#"><u>17-29</u></a>
<a href="#"><u>Applications</u></a>	<a href="#"><u>17-30</u></a>
<a href="#"><u>Physical Description</u></a>	<a href="#"><u>17-30</u></a>
<a href="#"><u>Data Features</u></a>	<a href="#"><u>17-35</u></a>
<a href="#"><u>Distance Limitations</u></a>	<a href="#"><u>17-35</u></a>
<a href="#"><u>Power Requirements</u></a>	<a href="#"><u>17-36</u></a>
<a href="#"><u>Switch Administration</u></a>	<a href="#"><u>17-37</u></a>
<a href="#"><u>The Service Profiler ID (SPID)</u></a>	<a href="#"><u>17-38</u></a>
<a href="#"><u>Hidden/Craft Features</u></a>	<a href="#"><u>17-38</u></a>
<a href="#"><u>Power Failure Operation</u></a>	<a href="#"><u>17-39</u></a>

<a href="#">FCC Registration</a>	17-39
<a href="#">Hearing Aid Compatible</a>	17-39
<a href="#">8510T Equipment PECs and Comcodes</a>	17-39
<a href="#">Adjuncts</a>	17-40
<a href="#">Additional Documents</a>	17-40
■ <a href="#">The ISDN 8520T Voice/Data Terminal</a>	17-41
<a href="#">Applications</a>	17-42
<a href="#">Physical Description</a>	17-42
<a href="#">Data Features</a>	17-47
<a href="#">Distance Limitations</a>	17-47
<a href="#">Power Requirements</a>	17-48
<a href="#">Switch Administration</a>	17-48
<a href="#">The Service Profiler ID (SPID)</a>	17-49
<a href="#">Hidden/Craft Features</a>	17-49
<a href="#">Power Failure Operation</a>	17-50
<a href="#">FCC Registration</a>	17-50
<a href="#">Hearing Aid Compatible</a>	17-50
<a href="#">8520T Equipment PECs and Comcodes</a>	17-50
<a href="#">Adjuncts</a>	17-51
<a href="#">Additional Documents</a>	17-51

**18 [Cordless and Wireless Telephones](#) 18-1**

■ <a href="#">The MDC 9000 Cordless Telephone</a>	18-2
<a href="#">Applications</a>	18-4
<a href="#">Physical Features</a>	18-4
<a href="#">Display Information</a>	18-7
<a href="#">Out-of-Range Indication</a>	18-7
<a href="#">Distance and Installation Limitations (for the Charging Base)</a>	18-7
<a href="#">Switch Administration</a>	18-8
<a href="#">FCC Registration</a>	18-10
<a href="#">Hearing Aid Compatibility</a>	18-10
<a href="#">MDC 9000 Equipment PECs and Comcodes</a>	18-10
<a href="#">Additional Documents</a>	18-11
■ <a href="#">The MDW 9000 Wireless Telephone</a>	18-12
<a href="#">Applications</a>	18-15

<a href="#">Physical Features</a>	18-15
<a href="#">Display Information</a>	18-18
<a href="#">Out-of-Range Indication</a>	18-19
<a href="#">Distance and Installation Limitations</a>	18-19
<a href="#">Switch Administration</a>	18-20
<a href="#">FCC Registration</a>	18-21
<a href="#">Hearing Aid Compatibility</a>	18-21
<a href="#">UL and CSA Approval</a>	18-22
<a href="#">MDW 9000 Equipment PECs and Comcodes</a>	18-22
<a href="#">Additional Documents</a>	18-23
■ <a href="#">The MDW 9031DCP Wireless Pocket Phone</a>	18-24
<a href="#">Applications</a>	18-27
<a href="#">Physical Features</a>	18-28
<a href="#">Out-of-Range Indication</a>	18-31
<a href="#">Distance and Installation Limitations</a>	18-31
<a href="#">Switch Administration</a>	18-33
<a href="#">FCC Registration</a>	18-34
<a href="#">Hearing Aid Compatibility</a>	18-34
<a href="#">UL and CSA Approval</a>	18-34
<a href="#">MDW 9031DCP Equipment PECs and Comcodes</a>	18-34
<a href="#">Additional Documents</a>	18-36

**19 Other Voice Terminals 19-1**

■ <a href="#">Voice Terminals Reusable from Other Systems</a>	19-1
<a href="#">Advantages of Reusable Terminals</a>	19-1
<a href="#">Disadvantages of Reusable Terminals</a>	19-1
■ <a href="#">Models 7302H, 7303H, 7305H01B, and 7305H02B</a>	19-2
■ <a href="#">Multi-Button Electronic Telephone (MET) Sets</a>	19-2

**20 Adjuncts 20-1**

■ <a href="#">Call Coverage Modules</a>	20-2
<a href="#">Applications</a>	20-3
<a href="#">Physical Description</a>	20-3
<a href="#">Power</a>	20-4
<a href="#">Considerations</a>	20-4
<a href="#">Call Coverage Module PECs</a>	20-4

- [Digital Display Modules](#) 20-5
  - [Applications](#) 20-6
  - [Physical Description](#) 20-6
  - [Power](#) 20-8
  - [Considerations](#) 20-8
  - [Digital Display Module PECs](#) 20-8
- [Function Key Modules](#) 20-9
  - [Applications](#) 20-10
  - [Physical Description](#) 20-10
  - [Power](#) 20-10
  - [Considerations](#) 20-10
  - [Digital Terminal Data Module PEC Codes](#) 20-11
- [The 801A Expansion Module](#) 20-12
  - [Applications](#) 20-13
  - [Physical Description](#) 20-13
  - [Power](#) 20-13
  - [Administering the 801A Expansion Module](#) 20-14
  - [801A Expansion Module PECs](#) 20-15
  - [Additional Documents](#) 20-15
- [The XM24 Expansion Module](#) 20-16
  - [Applications](#) 20-17
  - [Physical Description](#) 20-17
  - [Power](#) 20-17
  - [Administering the XM24 Expansion Module](#) 20-18
  - [XM24 Expansion Module PECs and Comcodes](#) 20-19
  - [Additional Documents](#) 20-19
- [The 100A Tip/Ring Module](#) 20-20
  - [Applications](#) 20-21
  - [Considerations](#) 20-21
  - [Physical Description](#) 20-22
  - [Power](#) 20-24
  - [Administering the Tip/Ring Module](#) 20-24
  - [100A Tip/Ring Module PECs and Comcodes](#) 20-24
  - [Additional Documents](#) 20-25
- [Headset Adapters](#) 20-26

<a href="#"><u>Applications</u></a>	<a href="#"><u>20-26</u></a>
<a href="#"><u>Physical Description</u></a>	<a href="#"><u>20-27</u></a>
<a href="#"><u>Power</u></a>	<a href="#"><u>20-27</u></a>
<a href="#"><u>Considerations</u></a>	<a href="#"><u>20-28</u></a>
<a href="#"><u>Typical Headsets</u></a>	<a href="#"><u>20-28</u></a>
<a href="#"><u>500A and 502A Headset Adapter PECs</u></a>	<a href="#"><u>20-28</u></a>
■ <a href="#"><u>The Z34A Message Waiting Indicator</u></a>	<a href="#"><u>20-29</u></a>
<a href="#"><u>Applications</u></a>	<a href="#"><u>20-29</u></a>
<a href="#"><u>Physical Description</u></a>	<a href="#"><u>20-30</u></a>
<a href="#"><u>Power</u></a>	<a href="#"><u>20-30</u></a>
<a href="#"><u>Message Waiting Indicator PECs</u></a>	<a href="#"><u>20-30</u></a>
■ <a href="#"><u>The 4A, S101A, and S102A Speakerphones</u></a>	<a href="#"><u>20-31</u></a>
<a href="#"><u>Applications</u></a>	<a href="#"><u>20-31</u></a>
<a href="#"><u>Physical Description</u></a>	<a href="#"><u>20-32</u></a>
<a href="#"><u>Power</u></a>	<a href="#"><u>20-33</u></a>
<a href="#"><u>Considerations</u></a>	<a href="#"><u>20-33</u></a>
<a href="#"><u>Speakerphone PECs</u></a>	<a href="#"><u>20-33</u></a>
■ <a href="#"><u>The S201A and S202A Speakerphones</u></a>	<a href="#"><u>20-34</u></a>
<a href="#"><u>Applications</u></a>	<a href="#"><u>20-34</u></a>
<a href="#"><u>Physical Description</u></a>	<a href="#"><u>20-35</u></a>
<a href="#"><u>Power</u></a>	<a href="#"><u>20-36</u></a>
<a href="#"><u>Considerations</u></a>	<a href="#"><u>20-36</u></a>
<a href="#"><u>S201A and S202A Speakerphone PECs</u></a>	<a href="#"><u>20-36</u></a>
■ <a href="#"><u>The S203A Speakerphone</u></a>	<a href="#"><u>20-37</u></a>
<a href="#"><u>Applications</u></a>	<a href="#"><u>20-38</u></a>
<a href="#"><u>Physical Description</u></a>	<a href="#"><u>20-38</u></a>
<a href="#"><u>Power</u></a>	<a href="#"><u>20-39</u></a>
<a href="#"><u>Bridging</u></a>	<a href="#"><u>20-39</u></a>
<a href="#"><u>FCC Registration</u></a>	<a href="#"><u>20-40</u></a>
<a href="#"><u>S203A Speakerphone PECs</u></a>	<a href="#"><u>20-40</u></a>
■ <a href="#"><u>The 107-Type Loudspeaker</u></a>	<a href="#"><u>20-41</u></a>
<a href="#"><u>Applications</u></a>	<a href="#"><u>20-41</u></a>
<a href="#"><u>Physical Description</u></a>	<a href="#"><u>20-42</u></a>
<a href="#"><u>Power</u></a>	<a href="#"><u>20-42</u></a>
■ <a href="#"><u>The 7404D (Voice Terminal) Messaging Cartridge</u></a>	<a href="#"><u>20-43</u></a>



<a href="#">Applications</a>	<a href="#">20-43</a>
<a href="#">Considerations</a>	<a href="#">20-44</a>
<a href="#">Messaging Cartridge PECs</a>	<a href="#">20-44</a>
■ <a href="#">The 2870A1 Automatic Dialer</a>	<a href="#">20-45</a>
<a href="#">Applications</a>	<a href="#">20-45</a>
<a href="#">Physical Description</a>	<a href="#">20-46</a>
<a href="#">Power</a>	<a href="#">20-46</a>
<a href="#">Automatic Dialer PECs</a>	<a href="#">20-46</a>

**21** [Data Modules](#) [21-1](#)

■ <a href="#">The 7400A Data Module</a>	<a href="#">21-3</a>
<a href="#">Applications</a>	<a href="#">21-3</a>
<a href="#">Physical Description</a>	<a href="#">21-4</a>
<a href="#">Tests</a>	<a href="#">21-5</a>
<a href="#">Capabilities</a>	<a href="#">21-5</a>
<a href="#">Power</a>	<a href="#">21-6</a>
<a href="#">Considerations</a>	<a href="#">21-6</a>
<a href="#">FCC Registration</a>	<a href="#">21-6</a>
<a href="#">7400A Data Module PECs</a>	<a href="#">21-6</a>
<a href="#">Additional Documents</a>	<a href="#">21-7</a>
■ <a href="#">The 7400B and 7400B Plus Data Module</a>	<a href="#">21-8</a>
<a href="#">Applications</a>	<a href="#">21-9</a>
<a href="#">Physical Description</a>	<a href="#">21-10</a>
<a href="#">Tests</a>	<a href="#">21-11</a>
<a href="#">Capabilities</a>	<a href="#">21-11</a>
<a href="#">Power</a>	<a href="#">21-12</a>
<a href="#">Setting Options</a>	<a href="#">21-12</a>
<a href="#">Notes for Use with PC Packages</a>	<a href="#">21-13</a>
<a href="#">FCC Registration</a>	<a href="#">21-13</a>
<a href="#">7400B Data Module PECs</a>	<a href="#">21-14</a>
<a href="#">Additional Documents</a>	<a href="#">21-14</a>
■ <a href="#">The 7400D Low-Speed Asynchronous Data Module</a>	<a href="#">21-15</a>
<a href="#">Applications</a>	<a href="#">21-15</a>
<a href="#">Physical Description</a>	<a href="#">21-16</a>
<a href="#">Power Supply Unit</a>	<a href="#">21-18</a>

<a href="#">Tests</a>	<a href="#">21-18</a>
<a href="#">Data Module Features</a>	<a href="#">21-18</a>
<a href="#">Setting Options</a>	<a href="#">21-19</a>
<a href="#">FCC Registration</a>	<a href="#">21-20</a>
<a href="#">7400D Data Module PECs</a>	<a href="#">21-20</a>
<a href="#">Additional Documents</a>	<a href="#">21-20</a>
■ <a href="#">The 8400B Plus Data Module</a>	<a href="#">21-21</a>
<a href="#">Applications</a>	<a href="#">21-21</a>
<a href="#">Physical Description</a>	<a href="#">21-25</a>
<a href="#">Tests</a>	<a href="#">21-27</a>
<a href="#">Capabilities</a>	<a href="#">21-27</a>
<a href="#">Power</a>	<a href="#">21-28</a>
<a href="#">Setting Options</a>	<a href="#">21-28</a>
<a href="#">Notes for Use with PC Packages</a>	<a href="#">21-29</a>
<a href="#">FCC Registration</a>	<a href="#">21-30</a>
<a href="#">8400B Plus Data Module PECs</a>	<a href="#">21-30</a>
<a href="#">Additional Documents</a>	<a href="#">21-30</a>
■ <a href="#">The 7500B Data Module</a>	<a href="#">21-31</a>
<a href="#">Applications</a>	<a href="#">21-31</a>
<a href="#">Physical Description</a>	<a href="#">21-32</a>
<a href="#">Capabilities</a>	<a href="#">21-33</a>
<a href="#">Distance Limitations</a>	<a href="#">21-34</a>
<a href="#">Power Requirements</a>	<a href="#">21-34</a>
<a href="#">FCC Registration</a>	<a href="#">21-34</a>
<a href="#">Additional Documents</a>	<a href="#">21-34</a>
■ <a href="#">The ISDN Asynchronous Data Module (ADM)</a>	<a href="#">21-35</a>
<a href="#">Physical Description</a>	<a href="#">21-35</a>
<a href="#">Features</a>	<a href="#">21-35</a>
<a href="#">Power Requirements</a>	<a href="#">21-36</a>
<a href="#">ISDN ADM PECs</a>	<a href="#">21-36</a>
<a href="#">Additional Documents</a>	<a href="#">21-36</a>
■ <a href="#">The Digital Terminal Data Module (DTDM)</a>	<a href="#">21-37</a>
<a href="#">Physical Description</a>	<a href="#">21-38</a>
<a href="#">Capabilities</a>	<a href="#">21-40</a>

<a href="#">Power</a>	<a href="#">21-40</a>
<a href="#">FCC Registration</a>	<a href="#">21-40</a>
<a href="#">DTDM Equipment PECs</a>	<a href="#">21-40</a>
<a href="#">Additional Documents</a>	<a href="#">21-40</a>
■ <a href="#">The Z702AL1 Data Service Unit (DSU)</a>	<a href="#">21-41</a>
<a href="#">Applications</a>	<a href="#">21-42</a>
<a href="#">Physical Description</a>	<a href="#">21-42</a>
<a href="#">Capabilities</a>	<a href="#">21-43</a>
<a href="#">Power</a>	<a href="#">21-43</a>
<a href="#">Z702AL1 DSU PECs</a>	<a href="#">21-44</a>
<a href="#">Additional Documents</a>	<a href="#">21-44</a>
■ <a href="#">The 703A Data Service Unit (DSU)</a>	<a href="#">21-45</a>
<a href="#">Applications</a>	<a href="#">21-46</a>
<a href="#">Physical Description</a>	<a href="#">21-46</a>
<a href="#">Capabilities</a>	<a href="#">21-47</a>
<a href="#">Power</a>	<a href="#">21-48</a>
<a href="#">703 DSU PECs</a>	<a href="#">21-48</a>
<a href="#">Additional Documents</a>	<a href="#">21-48</a>
■ <a href="#">The DEFINITY High Speed Link</a>	<a href="#">21-49</a>
<a href="#">Physical Description</a>	<a href="#">21-50</a>
<a href="#">Capabilities</a>	<a href="#">21-51</a>
<a href="#">Applications</a>	<a href="#">21-52</a>
<a href="#">Power</a>	<a href="#">21-55</a>
<a href="#">Considerations</a>	<a href="#">21-56</a>
<a href="#">FCC Registration</a>	<a href="#">21-56</a>
<a href="#">DEFINITY HSL PECs</a>	<a href="#">21-56</a>
<a href="#">Additional Documents</a>	<a href="#">21-56</a>
■ <a href="#">The Processor Data Module (PDM)</a>	<a href="#">21-57</a>
<a href="#">Physical Description</a>	<a href="#">21-58</a>
<a href="#">Capabilities</a>	<a href="#">21-59</a>
<a href="#">Power</a>	<a href="#">21-59</a>
<a href="#">PDM Equipment PECs</a>	<a href="#">21-59</a>
<a href="#">Additional Documents</a>	<a href="#">21-59</a>
■ <a href="#">The Trunk Data Module (TDM)</a>	<a href="#">21-60</a>
<a href="#">Physical Description</a>	<a href="#">21-61</a>

<a href="#">Capabilities</a>	<a href="#">21-62</a>
<a href="#">Power</a>	<a href="#">21-62</a>
<a href="#">TDM Equipment PECs</a>	<a href="#">21-62</a>
<a href="#">Additional Documents</a>	<a href="#">21-62</a>
■ <a href="#">The Modular Processor Data Module (MPDM)</a>	<a href="#">21-63</a>
<a href="#">General Features of the MPDM</a>	<a href="#">21-65</a>
<a href="#">Features of the AUDIX/CMS MPDM Package</a>	<a href="#">21-67</a>
<a href="#">Features of the Video Teleconferencing MPDM</a>	<a href="#">21-68</a>
<a href="#">Features of the High Speed Synchronous MPDM</a>	<a href="#">21-70</a>
<a href="#">MPDM PECs and Comcodes</a>	<a href="#">21-71</a>
<a href="#">Additional Documents</a>	<a href="#">21-72</a>
■ <a href="#">The Modular Trunk Data Module (MTDM)</a>	<a href="#">21-73</a>
<a href="#">Physical Description</a>	<a href="#">21-74</a>
<a href="#">Capabilities</a>	<a href="#">21-75</a>
<a href="#">Power</a>	<a href="#">21-75</a>
<a href="#">MTDM Equipment PECs</a>	<a href="#">21-75</a>
<a href="#">Additional Documents</a>	<a href="#">21-76</a>
■ <a href="#">The 3270 Data Module</a>	<a href="#">21-77</a>
<a href="#">The 3270A and 3270T</a>	<a href="#">21-79</a>
<a href="#">The 3270C</a>	<a href="#">21-80</a>
<a href="#">3270 Equipment PECs</a>	<a href="#">21-81</a>
<a href="#">Additional Documents</a>	<a href="#">21-81</a>
■ <a href="#">The Asynchronous Data Unit (ADU)</a>	<a href="#">21-82</a>
<a href="#">Physical Description</a>	<a href="#">21-83</a>
<a href="#">Capabilities</a>	<a href="#">21-84</a>
<a href="#">Power</a>	<a href="#">21-84</a>
<a href="#">Z3A Data Module PECs</a>	<a href="#">21-85</a>
<a href="#">Additional Documents</a>	<a href="#">21-85</a>
■ <a href="#">The Multiple Asynchronous Data Unit (MADU)</a>	<a href="#">21-86</a>
<a href="#">Capabilities</a>	<a href="#">21-86</a>
<a href="#">Physical Description</a>	<a href="#">21-86</a>
<a href="#">Power</a>	<a href="#">21-88</a>
<a href="#">MADU Circuit Pack PECs</a>	<a href="#">21-88</a>
<a href="#">Additional Documents</a>	<a href="#">21-88</a>
■ <a href="#">DCIU Interface Units</a>	<a href="#">21-89</a>

<a href="#">105A IDI</a>	<a href="#">21-89</a>
<a href="#">48250 LDSU</a>	<a href="#">21-89</a>
<a href="#">2500-Series DSU</a>	<a href="#">21-89</a>
■ <a href="#">The 2500-Series DSU</a>	<a href="#">21-90</a>
<a href="#">Physical Description</a>	<a href="#">21-90</a>
<a href="#">Capabilities</a>	<a href="#">21-90</a>
<a href="#">Mounting</a>	<a href="#">21-91</a>
<a href="#">Power</a>	<a href="#">21-91</a>
<a href="#">Distance Limitations</a>	<a href="#">21-91</a>
<a href="#">2500-Series DSU PECs</a>	<a href="#">21-91</a>
<a href="#">Additional Documents</a>	<a href="#">21-91</a>

<b><a href="#">22</a></b> <b><a href="#">PC Platforms (PC/PBX and PC/ISDN) and Application Software</a></b>	<b><a href="#">22-1</a></b>
■ <a href="#">PC Platforms (PC/PBX and PC/ISDN)</a>	<a href="#">22-2</a>
<a href="#">Overview</a>	<a href="#">22-2</a>
<a href="#">Platforms</a>	<a href="#">22-2</a>
<a href="#">PC/PBX and PC/PBX MicroChannel Platforms</a>	<a href="#">22-3</a>
<a href="#">PC/ISDN Platform</a>	<a href="#">22-4</a>
<a href="#">Additional Documents</a>	<a href="#">22-5</a>
■ <a href="#">PC/PBX Connection</a>	<a href="#">22-6</a>
<a href="#">Applications</a>	<a href="#">22-6</a>
<a href="#">Capabilities</a>	<a href="#">22-6</a>
<a href="#">PC/PBX PECs</a>	<a href="#">22-7</a>
<a href="#">Additional Documents</a>	<a href="#">22-7</a>
■ <a href="#">E78 Plus/ISDSN Software</a>	<a href="#">22-8</a>
<a href="#">Applications</a>	<a href="#">22-8</a>
<a href="#">Physical Description</a>	<a href="#">22-8</a>
<a href="#">Capabilities</a>	<a href="#">22-8</a>
<a href="#">E78 PECs</a>	<a href="#">22-9</a>
<a href="#">Additional Documents</a>	<a href="#">22-9</a>
<b><a href="#">23</a></b> <b><a href="#">Blank Templates for Model Design</a></b>	<b><a href="#">23-1</a></b>



# Introduction

# 1

---

## The Purpose of This Manual

Voice terminals and adjuncts are voice and data devices that are connected to the system switch in a business communications system. This manual provides concise physical and functional descriptions of the voice terminals/telephones, adjuncts, and data modules that can be used with the DEFINITY<sup>®</sup> Communications System Generic 1, Generic 2, and Generic 3, the DEFINITY<sup>®</sup> Enterprise Communications Server (ECS), Release 5, Release 6, and Release 7, System 75, and System 85. The book is intended as an aid for both Lucent Technologies and customer personnel in selecting appropriate components for these systems and for the training of personnel and management of the system.

This issue replaces all previous issues of this document. The reason for reissue is to add more information on the items included in previous issues of this document and to include the following new items:

- The modular 6416D+M and 6424D+M telephones
- The 100A Tip/Ring Interface Module which can be connected with the modular 6416D+M and 6424D+M telephones
- The CALLMASTER<sup>®</sup> V console
- The new 6200 Series analog telephones which include the 6210, 6218, and 6220 telephones. The 6201 and 6230 which appeared in the last issue have been removed since, at the last moment, it was decided that these two models would not be part of the 6200 Series analog telephone offer.
- The 2500 MMGN, 2500 YMGP, 2554 MMGN, and the 2554 YMGP analog telephones
- The MDW 9031DCP Wireless Pocket Phone

1 Introduction

*The Purpose of This Manual*

1-2

In Issue 3, three new sections were added and have since been maintained to reflect new products that have been introduced. The **Exposed Port Protection** section discusses the different protection required for lightning protection. The **Adjunct Power** section discusses the different types of adjunct power supplies available. The **Administration** section discusses how to administer some of the newer terminals when the software of the version switch being used does not contain the proper administration procedures for the new terminal.

 **NOTE:**

Issue 3 and subsequent issues of this document also had an Availability chapter which listed the availability of each terminal and adjunct described in this book. However, interpretations of the meaning of “availability” differed among the readers of this manual, and, therefore, the chapter raised more questions than it provided meaningful information. As a result, in this issue, the Availability chapter has been omitted. However, information on whether the product is still being manufactured continues to appear in the subsection on each individual terminal or adjunct. If questions about availability of any Lucent Technologies product remain, contact your local account executive.

The equipment covered in this manual includes the following specific groups:

- Telephones/Voice Terminals
- Adjuncts used with the voice terminals to enhance voice operations
- Data Modules (adjuncts that support data operations)
- PC Platforms (PC/PBX) and Application Software

Attendant consoles, applications processors (APs), printers, and data terminals used with APs are not described in this manual.

Figure 1-1 shows a typical arrangement of terminals and adjuncts connected to the system switch.



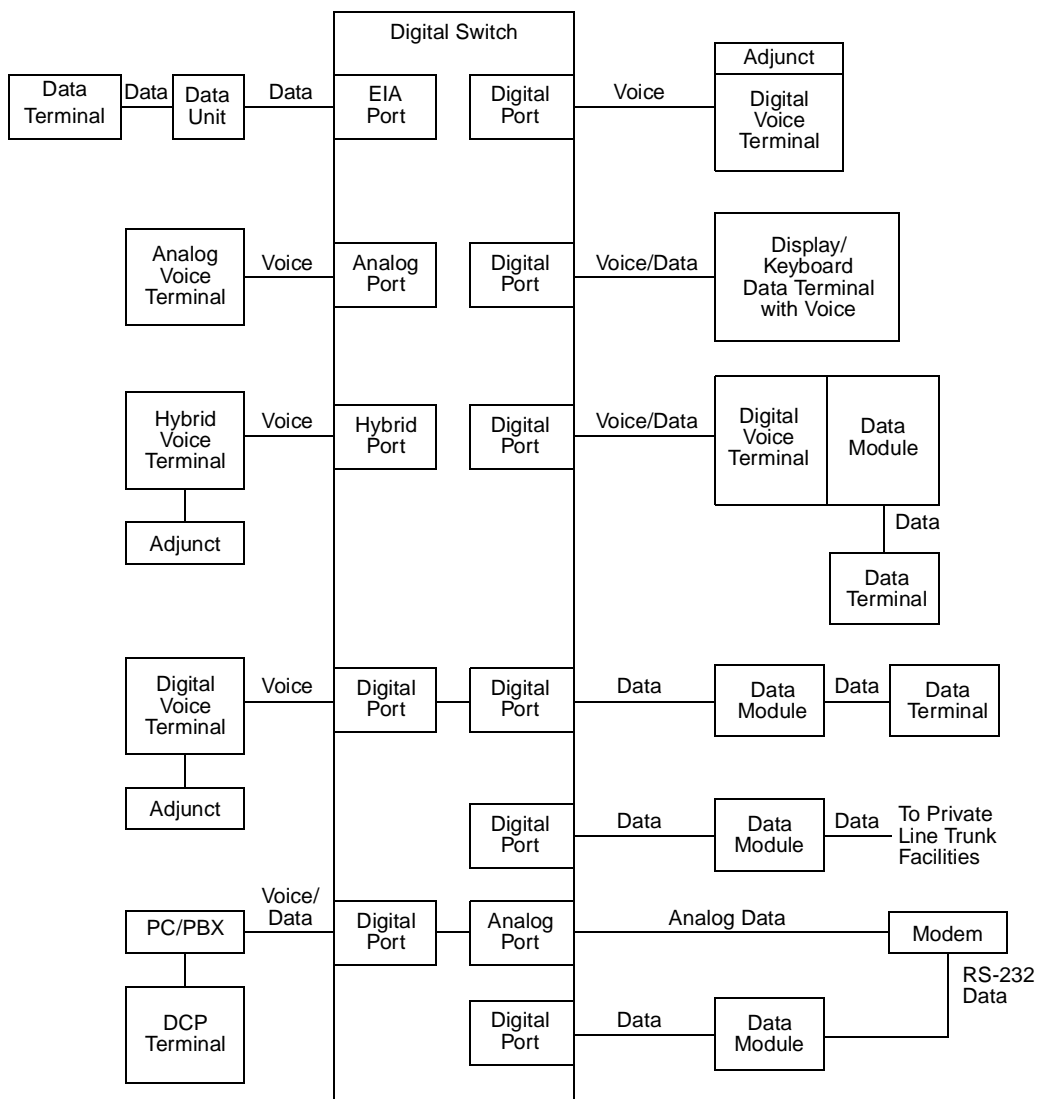

Figure 1-1. Interface Between System Switch and Typical Terminals/Adjuncts

## The Organization of This Manual

The remainder of this manual is divided into nine main sections; tabs are provided for convenient access to each section. All equipment descriptions are supported by illustrations.

**General Information** — Gives background data that applies to the entire range of equipment covered in this manual.

**Exposed Port Protection** — Contains information on the protection required by exposed ports. This section also lists some of the Lucent Technologies protection devices and gives parameters that non-Lucent Technologies devices must meet.

**Adjunct Power** — Lists the different terminals and adjuncts that require adjunct power supplies and the recommended adjunct power supply. Information has also been provided about the MSP-1 local power supply and, more recently, about the 1151A1 and the 1151A2 with Battery Holdover which has replaced the MSP-1.

**Administration** — When some of the newer terminals are used with some older versions of the switches, the administration of the switch does not allow for the use of the new terminals. These new terminals must be administered using the administration procedures of a similar older terminal. This is called aliasing. This section contains the aliasing information and the appropriate caveats.

**Voice Terminals** — Provides detailed coverage of the main groups of voice terminals, divided into 13 tabbed subsections. This section contains detailed information on each voice terminal that can be ordered as a component of a DEFINITY switch, System 75, or System 85. It also contains brief descriptions of voice terminals that were previously installed in earlier business communications systems. Before you install the voice terminal or telephone, check each description to see if these voice terminals are compatible with a DEFINITY G1, G2, or G3, a DEFINITY ECS, System 75, or System 85.

The 13 tabbed subsections and the voice terminals described in each subsection are listed as follows:

**6400 SERIES**

Models 6402 and 6402D  
Models 6408+ and 6408D+  
Models 6416D+ and 6416D+M  
Models 6424D+ and 6424D+M

**7100 SERIES**

Model 7101A  
Models 7102A and 7102 Plus  
Models 7103A Fixed Feature and  
7103A Programmable  
Model 7104A

**7200 SERIES**

Model 7203H  
Model 7205H

**7300 SERIES**

Model 7303S  
Model 7305S

**7400 SERIES**

Model 7401D  
Model 7401 Plus  
Model 7402 Plus  
Model 7403D  
Model 7404D  
Model 7405D  
Model 7406D  
Model 7406 BIS  
Model 7406 Plus  
Model 7407D  
Model Enhanced 7407D  
Model 7407 Plus  
Model 7410D  
Model 7410 Plus  
Model 7434D  
Model 7444

**8400 SERIES**

Model 8403  
Model 8405  
Model 8410  
Model 8411  
Model 8434 and 8434DX

**CALLMASTER**

602 CALLMASTER  
CALLMASTER II  
CALLMASTER III  
CALLMASTER IV  
CALLMASTER V  
CALLMASTER VI

**500/2500 SERIES**

Model 500 Series  
Model 2500 Series  
Model 2500 DMGC  
Model 2500 YM GK  
Models 2500 MMGL and 2500 MMGM  
Models 2500 YMGL and 2500 YMGM  
Models 2500 YMGN and 2500 YMGP

**6200 SERIES**

Model 6210  
Models 6218 and 6220

**8100 SERIES**

Models 8101 and 8102M  
Models 8102 and 8102M  
Models 8110 and 8110M

**ISDN VOICE TERMINALS**

Model 7505 ISDN  
Model 7506 ISDN  
Model 7507 ISDN  
Model 8503T ISDN  
Model 8510T ISDN  
Model 8520T ISDN

**CORDLESS/WIRELESS TELEPHONES**

MDC 9000 Cordless Telephone  
MDW 9000 Wireless Telephone  
MDW 9031DCP Wireless Pocket Phone

**OTHER**

Voice terminals reusable  
from other systems:  
Models 7203H, 7303H,  
7305H01B, and 7305H02B  
Multi-Button Electronic  
Telephone (MET) Sets

**Adjuncts** — Contains information on the devices that can be used with voice terminals to supplement services and features. This section contains information on the controls, buttons, lights, and functions of a DEFINITY G1, G2, and G3, a DEFINITY ECS, System 75, or System 85 voice terminals and telephone adjuncts. Adjuncts that are identical in appearance and function, but have different codes, are covered under the same heading. Adjuncts that are basically data modules are covered in the **Data Modules** section in this manual.

The adjuncts covered in this section are:

Call Coverage Modules	Message Waiting Indicator
Digital Display Module	Speakerphones
Function Key Module	Loudspeaker
Expansion Modules	Messaging Cartridge
Tip/Ring Interface Module	Automatic Dialer
Headset Adapters	

**Data Modules** — Contains information on the devices that provide data communications interface. This section contains information on the data modules and other related data equipment used with a DEFINITY G1, G2, and G3, a DEFINITY ECS, System 75, or System 85. These devices provide data interface functions which include modems, protocol converters, and data units.

The data modules covered in this section are:

-7400A Data Module	-Modular Processor Data Module (MPDM)
-7400B and 7400B Plus Data Module	-Modular Trunk Data Module (MTDM)
-7400D Data Module	-3270 Data Module
-7500B Data Module	-Asynchronous Data Unit (ADU)
-8400B Plus Data Module	-Multiple Asynchronous Data Unit (MADU)
-ISDN Asynchronous Data Module (ADM)	-DCIU Interface Units
-Digital Terminal Data Module (DTDM)	-2500-SERIES Data Service Unit
-Z702AL1 Data Service Unit	-Modems (Data Sets)
-703A Data Service Unit	-Local Distribution Service Unit (LDSU)
-DEFINITY High Speed Link (HSL)	-Isolating Data Interface (DI)
-Processor Data Module (PDM)	-Protocol Converters
-Trunk Data Module (TDM)	

**PC Platforms (PC/PBX and PC/ISDN) and Application Software** — Contains information on the different PC/PBX Platforms, the PC/PBX Connection, and E78 Plus®/ISDN.

**Blank Templates for Model Design** — Includes blank templates of voice terminal faceplates on which the Software Associate can designate the numbers, feature codes, or features to be administered on each voice terminal button.

## General Information

# 2

---

This section provides general information on all of the equipment described in this manual. Information is provided on voice terminals, adjuncts, data modules, and data terminals. Detailed information on these types of equipment can be found behind the tab for each particular type of equipment.

## Voice Terminals

---

The advanced, multi-appearance voice terminals combine the capabilities of both a telephone and a terminal and have a variety of controlling and monitoring functions. While providing basic telephone service (placing and answering calls), voice terminals can also be used to activate the advanced features of the system.

This part explains higher level topics that apply to voice terminals as a group and contains descriptions of facilities and characteristics that are common to all or most terminals. Table 2-1 presents a summary of all voice terminals used with a DEFINITY G1, G2, and G3, a DEFINITY ECS, System 75, and System 85.

The complete line of voice terminals are two basic types, *single-line voice terminals* and *multi-appearance voice terminals*. The operational differences between these types are in the way they access features and the way they receive calls.

## Single-Line Voice Terminals

The term “single-line” means that only one incoming call can be ringing at an idle terminal. Once an incoming call has been answered, however, a single-line voice terminal can handle both the active call and another call on hold or waiting. When a single-line terminal user is busy on a call, an incoming call does not ring but alerts the user via a “call waiting tone” (in the handset or speakerphone) that a call

is waiting to be answered. While a single-line terminal is occupied with two calls, any other calls placed to the terminal get a busy tone.

All single-line voice terminals are analog in operation; that is, transmission of all signals between the terminal and its port, at the system digital switch, is in analog form over a tip and ring pair of wires. The port circuit provides analog/digital signal conversion. Power for these terminals is supplied from the switch on the single voice pair. Single-line terminals have many applications but are more limited in their access to system features than multi-appearance terminals.

## Multi-Appearance Voice Terminals

A multi-appearance voice terminal gives its user much more flexibility in handling calls than a single-line voice terminal. A multi-appearance voice terminal, represented by a unique primary extension number, has multiple call appearances (buttons with lights) where incoming calls to the number can be answered and outgoing calls can be originated. Incoming calls can ring simultaneously at all appearances except for those translated as originate-only. As long as at least one appearance is idle, callers will not receive busy tone. When all call appearances, except call appearances translated as originate-only, are busy, callers will hear busy tone unless the incoming call is a priority call or the Restrict Last Appearance feature is deactivated. The terminal user must decide the order to answer multiple incoming calls.

The two sub-types of multi-appearance voice terminals are digital and hybrid. Digital terminals generate and receive voice and control signals in digital form. Connection between terminals and the system switch is over 2-pair digital links; no conversion is necessary at the digital line port. Hybrid terminals, as the name implies, combine analog and digital. They are connected to the system switch by three pairs of links; on MET<sup>\*</sup>-like hybrid sets, one pair is for analog voice, and the other two pairs are for digital control signals, and on ATL<sup>†</sup>-like hybrid sets, one pair is for digital control signals, and the other two pairs are for analog voice. DC power for all multi-appearance terminals (except for the 7404D and 7407D01B, which are AC powered) is conducted from the switch over the digital pairs.

Digital multi-appearance voice terminals have several important advantages over hybrids:

---

\* The Multi-Button Electronic Telephone (MET) sets are described in Chapter 19, “Other Voice Terminals.”

† Analog Terminal Loop (ATL) protocol is used predominantly in MERLIN telephone sets.

**2** General Information  
*Voice Terminals*

2-3

- Digital voice terminals can support and control data terminals.
- The Digital Communications Protocol (DCP) or ISDN-BRI interface between a digital voice terminal and the system switch supports simultaneous voice and data calls over the terminal's standard mounting cord.
- Digital terminals have a wider selection of adjuncts.
- Call information displays are available with some digital voice terminals.

**Table 2-1. Voice Terminals Usable with DEFINITY, System 75,  
and System 85**

<b>Type</b>	<b>Model</b>
Single-Line Analog	2500 Series 2500 DMGC 2500 YMGL/2500 YMGL/2500 YMGM 2500 MMGL/2500 MMGM, 2500 MMGN/2500 YMGP 6210, 6218, 6220 7101A 7102A, 7102 Plus 7103A Fixed Feature and 7103A Programmable 7104A (usable only with DEFINITY G1 and System 75) 8101, 8101M, 8102, 8102M, 8110, and 8110M
Multi-Appearance Hybrid	7203H (usable only with DEFINITY G2 and System 85) 7205H (usable only with DEFINITY G2 and System 85) 7303S 7305S
Single-Appearance Digital	6402 and 6402D 7401D and 7401 Plus These four models (have two virtual* appearances, but no call appearance buttons)
Multi-Appearance Digital	6408, 6408+, 6408D, 6408D+, 6416D+, 6416D+M, 6424D+, and 6424D+M 7402 Plus 7403D, 7404D, 7405D 7406D, 7406BIS, 7406 Plus 7407D, Enhanced 7407D, 7407 Plus 7410D, 7410 Plus 7434D 7444 8403, 8405, 8410, 8411, 8434, and 8434DX 602A, 602D CALLMASTER CALLMASTER II with Recorder Interface CALLMASTER III without Recorder Interface CALLMASTER IV CALLMASTER V CALLMASTER VI
ISDN Terminals	7505, 7506, 7507 (usable only with DEFINITY) 8503T, 8510T, 8520T (usable only with DEFINITY G2 and G3)
Cordless and Wireless	MDC 9000 Cordless Telephone MDW 9000 Wireless Telephone

*Continued on Next Page*



**Table 2-1. Voice Terminals Usable with DEFINITY, System 75,  
and System 85 — Continued**

Type	Model
Single-Line Analog	500 (can also be ordered new) 2500 Series (can also be ordered new)
Multi-Appearance Hybrid (MERLIN <sup>®</sup> )	7305H, 7305H01B, and 7305H02B
Multi-Button Electronic Telephone (MET) Sets	10 Button with or without Built-In Speakerphone, 20 Button, 30 Button 7203M (12 button)

\* The word "virtual" refers to the fact that there are no call appearance buttons associated with either appearance. Refer to the description of the 7401D and 7401 Plus Voice Terminal for more information.

## Facilities Common to All Voice Terminals

Every DEFINITY G1, G2, and G3, DEFINITY ECS, System 75, and System 85 voice terminal has the following equipment:

- A pushbutton pad for touch-tone dialing (except for the Model 500, which has a rotary dial).
- A handset with a coiled modular cord.
- A 7-foot modular mounting cord (except for the Model 2554 wall set).

## Buttons

All multi-appearance voice terminals and most single-line terminals have buttons for handling calls and activating various functions that enhance basic calling.

### Fixed Feature Buttons

Buttons that are factory labeled and require no administration are referred to as fixed feature buttons. The following buttons, in several combinations, are found on most voice terminals. They are dedicated to standard calling functions and are located adjacent to or above the pushbutton dial pad for calling convenience.

#### NOTE:

Fixed feature buttons that are limited to a small number of terminals are explained in the detailed descriptions of those terminals.

- **Recall Button** (on older sets)—provides a timed flash that is more accurate than a manual switchhook flash and prevents accidental dropping of calls. The following list of uses for this button is only valid for single-line terminals:

- Put an active call on hold and obtain recall dial tone for making another call.
- Disconnect from a second call and return to a call on hold, when pressed twice.
- Place an active call on hold and answer a waiting call using Dial Access Code, then toggle between the two calls (using the Recall button and Dial Access Code).
- Place an active call on hold; receive recall dial tone, and dial the Feature Access Code to answer a waiting call. Toggle between the two calls by performing the same action.
- Add a party, previously put on hold, to a conference with a third party.
- Drop the party previously added.
- **Disconnect** Button (on older sets)—allows the terminal user, after completing one call, to permanently disconnect from the call and get dial tone for placing a new call without going on- and off-hook. On System 85 and DEFINITY G2, depending on the administration, this button can be used to reconnect to the call on hold on multiple appearance voice terminals.
- **Hold** Button—is used to temporarily disconnect from one call, without dropping it, so that another call can be answered or originated. The user can return to the call on hold.
- **Drop** Button—is used to permanently disconnect the last party added to a conference call. On System 85 and DEFINITY G2, this button also gives dial tone on the same call appearance if dialing or on a 2-party call.

 **NOTE:**

On some voice terminals, this button is also used to perform a test of the voice terminal's lights, ringer, and display (if the terminal has one).

- **Conference** Button—enables the terminal user to set up a conference call by adding new calls to an existing 2-party connection. The user can add as many as five calls to a conference. (On System 85 and DEFINITY G2 the user can only build a 3-party conference call using this button; 6-party conference calls can be built by the attendant.)

 **NOTE:**

On some voice terminals, this button is also used to select a personalized ring from eight available ringing patterns.

- **Transfer** Button—enables the terminal user to shift an active call to another voice terminal.
- **Select Ring** Button (on older sets)—enables the terminal user to select a personalized ringing pattern.

- **Speaker Button**—turns on either a listen-only speaker or a 2-way speakerphone which allows the user to speak and listen to the far-end party.

**NOTE:**

On some voice terminals, this button also allows the user to initiate an acoustic test of the surrounding environment (the Reset Speakerphone feature) through a series of tones. When the tones stop, the speakerphone has finished adjusting itself for optimal performance.

- **Mute Button**—turns off the microphone of the built-in speakerphone or the handset so the other person on the call cannot hear you.

## Administrable Buttons

Buttons that are not fixed feature buttons are administered (or assigned) by the System Manager or the terminal user for many functions. Buttons that may be administered include call appearance/feature buttons and feature-only buttons.

Every multi-appearance voice terminal has a minimum of three buttons while others have as many as 34 buttons that can be administered as call appearances, that is, positions for answering incoming calls and originating outgoing calls (see Figure 2-1). In DEFINITY G1, G3, and System 75, software defaults the first three of these buttons for appearances of the terminal's primary (or home) extension number; the System Manager has the option of administering Button #3 differently. In DEFINITY G2 and System 85, no buttons are defaulted for the primary extension number; the System Manager *must* administer all the required positions. Buttons not used for the primary extension number can be assigned as appearances of other extensions or for activating optional features.

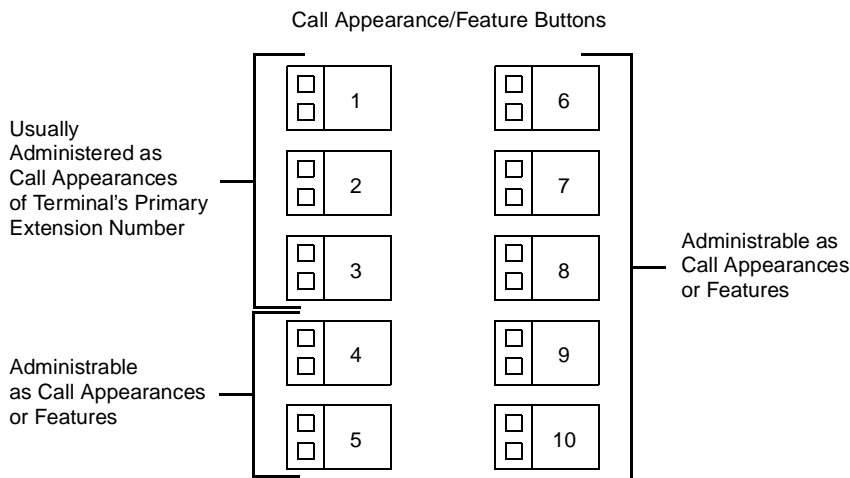

NOTE: Example shows button field of 7410 Plus voice terminal. Other terminals may have different arrangements, but Buttons 1, 2, and 3 are always present.

Figure 2-1. Call Appearance/Feature Buttons

Associated with each call appearance/feature button is a pair of lights that provide information on the availability and status of the appearance. These lights are described in the next part of this manual (titled "Lights").

Any button that can be administered and is not used for a call appearance can be assigned to an optional feature. Included in this category are buttons with two lights (call appearance/feature buttons) and buttons with one or no lights, intended specifically for features. Some features require light feedback to inform the terminal user when the feature is active; others are simple, one-time operations for which light feedback would be meaningless. Good feature administration matches features to appropriate buttons whenever possible.

## Lights

Indicator lights provide silent visual reminders to the voice terminal user regarding lines, features, and messages taken at other locations. The lights on voice terminals connected to a DEFINITY G1, G2, and G3, a DEFINITY ECS, System 75, or System 85 are light-emitting diodes (LEDs) or neon lights.

On all multi-appearance voice terminals, each call appearance/feature button has two indicator lights: a red light and a green status light. When a call appearance/feature button is used for a feature, only the status light is

operational; the red light remains off at all times. Feature-only buttons have either a single green status light or no light at all. The various arrangements of red and green lights are shown in Figure 2-2.

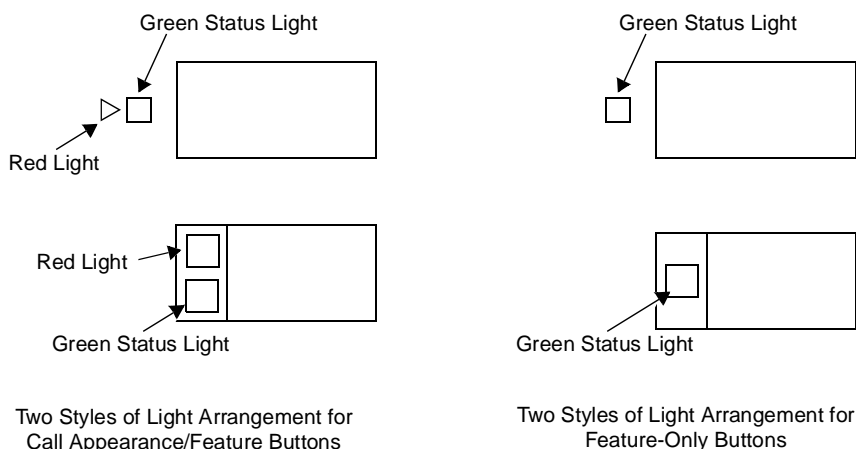

Figure 2-2. Button Lights

## Red Light

The red light normally has two states: lighted steadily or dark (off).



### NOTE:

On the ISDN-BRI 7505, 7506, and 7507 sets, the red light flashes when the set is using phantom power.

One red light is always on at a multi-appearance voice terminal when the handset is on hook. It identifies the call appearance the user will be automatically connected to if the handset is lifted. When the handset is lifted, the red light identifies the call appearance that is active.

The red light is off when the handset is lifted but not connected to a call appearance. For example, when one call has been put on hold but another call appearance button has not been pressed. When certain features such as Preselection, Idle Line Originating preference, or No Line Originating Preference are administered, the red light is also off while on hook.

## Green Status Light

The green status light can indicate any one of the following six conditions:

- Off—the call appearance is idle or the assigned feature is not activated.

- Lighted steadily—the call appearance is busy or the assigned feature is active.
- Flashing (slow on-off for equal periods, one cycle per second)—an unanswered incoming call on that call appearance.
- Fluttering (fast on-off for equal periods, 10 cycles per second)—a call placed on hold on that call appearance by the voice terminal user.
- Broken Fluttering (fast on-off modulated at the slow rate)—feature denial to the calling voice terminal or an unknown or invalid action.
- Winking (long on-short off at about three cycles per second)—a call placed on hold from another voice terminal or an action pending.

## Message Light

The Message light, when on, indicates that a message is waiting for the voice terminal's user (for example, Leave Word Calling or voice mail messages). When the user retrieves the message, the light is automatically turned off.

## Tones

---

The tones that a voice terminal user hears can be divided into two categories:

- Ringing Tones—those that are generated in the base of the voice terminal and can be heard in the surrounding area; they indicate incoming calls.
- Handset Tones—those that are transmitted through the handset and heard only by the user or through the speakerphone when it is turned on.

## External Ringing Tones

Ringing tones are the only tones heard *outside the voice terminal* when it is receiving a call. This signal cycles in 1-, 2-, or 3-ring patterns. On System 75 and DEFINITY G1 and G3, only one cycle of ringing is heard if the multi-appearance voice terminal is busy with another call. On System 85 and DEFINITY G2, the cycling repeats (except on the ISDN 7500-series sets).

- One ring—a call from another voice terminal in the system
- Two rings—a call from the attendant or outside caller
- Three rings—priority calls, for example, Automatic Callback, Priority Calling, or Ringback from a queued call
- One short unmodulated tone—an intercom call
- Ring-Ping (half ring)—a call redirected away from the voice terminal because Send All Calls or Call Forwarding is active; also called coverage tone.
- On System 85 and DEFINITY G2, any of these external tones, plus a repeated unmodulated tone, may be administered to indicate an intercom call.

## Handset Tones

The following tones are heard through the handset:

- **Answer Tone**—a high-pitched continuous tone indicating that a data endpoint has answered.
- **Busy Tone**—a low-pitched tone repeated 60 times a minute; indicates that the number dialed is in use.
- **Call Waiting Tone (Single-Line Voice Terminals)**—one, two, or three beeps (short bursts of high-pitched tone), not repeated; indicates to the user at a busy single-line terminal that an incoming call is waiting to be answered. The number of beeps indicates the source of the waiting call:
  - One beep—a call from another voice terminal in the system
  - Two fast beeps—a call from the attendant or an outside caller
  - Three fast beeps—a priority call
- **Confirmation Tone**—(three short bursts of tone) indicates that a feature activation or cancellation has been accepted, or that an outgoing call from a single-line voice terminal has been placed in a ringback queue.
- **Coverage Tone**—(one long burst of tone) indicates to the calling party that a call to an extension number will be answered at another extension number by a covering user.
- **Dial Tone**—(a continuous steady tone) indicates that dialing or feature activation can begin.
- **Intercept Tone**—(an alternating high and low tone) indicates either a dialing error or a denial of the service requested.
- **Recall Dial Tone**—(three short bursts of dial tone followed by steady dial tone) indicates that the feature requested has been accepted and dialing can start.
- **Recorded Telephone Dictation Ready Tone**—(a high-pitched continuous tone) indicates that a dictation machine has been connected to the voice terminal.
- **Reorder Tone**—(a fast-busy tone repeated 120 times a minute) indicates that all outgoing trunks are busy or feature resource is not available. Try again.
- **Ringback Tone**—(a low-pitched tone repeated 15 times a minute) indicates to the calling party that the number dialed has been reached successfully and is ringing.
- **Ringback Tone, Call Waiting**—(a ringback tone with a short lower-pitched signal at the end) indicates to the calling party that the extension called is busy, but that the called party has been given the call waiting signal.
- **Time-Out Tone**— (an alternating high and low tone [same as intercept tone]) indicates a failure to dial within a preset interval (usually 10 seconds) after lifting the handset or after dialing the previous digit.

- **Warning Tone (Bridging)**—(a low-pitched tone heard by all parties in a Busy Verification attempt that bridges on to an active call) initially applied in a 2-second (System 75 and G1) or 4-second (System 85 and G2) burst, then in half-second bursts every 15 seconds.

## Desk/Wall Mounting Arrangements

---

All the voice terminals covered in this manual, except the Model 2554, are intended for free-standing desktop use. However, wall-mounting is feasible for many terminals and appropriate kits are available. The detailed description of each voice terminal contains wall-mounting information and limitations.

## Adjuncts

---

Adjuncts are optional devices that extend the existing capabilities of voice terminals or provide new services. Some adjuncts are physically attached to their voice terminals, and others are free-standing, connected by way of mounting cords. The adjuncts have styling and colors that are compatible with the associated voice terminals.

Table 2-2 provides a cross-reference between adjuncts and the voice terminals with which they are used. The following limitations apply to the use of multiple adjuncts:

- A speakerphone and a headset adapter cannot be connected to the same voice terminal simultaneously because they plug into the same jack on the terminal.
- A C401A Call Coverage Module and a D401A Digital Display Module cannot be mounted on the same 7405D or 7434D Voice Terminal simultaneously because they attach to the same part of the terminal.

None of the adjuncts have facilities for wall mounting, and wall-mounting kits are not available. However, the modules (call coverage, function key, and digital display) are attached to their voice terminals, which can then be mounted on a wall. Free-standing adjuncts (speakerphones and headset adapters) associated with wall-mounted terminals can be placed on a nearby shelf or table.



**Table 2-2. Adjunct/Voice Terminal Compatibility**

Adjunct	Terminals	Function
Call Coverage Module, C201A	7205H	Adds 20 call appearance/ feature buttons
Call Coverage Module, C401A	7405D 7434D	
Call Coverage Module, C401B	7405D 7434D	
Digital Display Module, D401A	7405D 7434D	Displays call-related and personal service information
Digital Display Module, D401B	7405D 7434D	
Function Key Module, F201A	7205H	Adds 24 feature buttons
Function Key Module, F401A	7405D	
Headset Adapter, 500A	6402, 6402D, 6408, 6408+, 6408D, 6408D+, 6416D+, 6424D+  7102 Plus 7103A 7203H 7205H 7401 Plus 7402 Plus 7403D 7405D 7406D 7406BIS 7406 Plus Enhanced 7407D 7407 Plus	Provides for connection and control of standard headset

*Continued on Next Page*

Table 2-2. Adjunct/Voice Terminal Compatibility — Continued

Adjunct	Terminals	Function
Headset Adapter, 500A (continued)	7410D 7410 Plus 7434D 7444 8403, 8405, 8410, 8411, 8434/8434DX CALLMASTER 8102 7505,06,07 ISDN 8503T ISDN 8510T ISDN 8520T ISDN 515 BCT	
Headset Adapter, 502A	7303S 7305S	Provides for connection and control of standard headset
Message Waiting Indicator, Z34A	2500	Indicates that a message has been left for the terminal
Messaging Cartridge	7404D	Provides display of call-related and personal service information on data terminal screen
PC/PBX Plug-in Cartridge	7404D	Provides interface with PCs
Speakerphone, S101A Speakerphone, S201A	Same as 500A Headset Adapter	Provides hands-free calling

*Continued on Next Page*

Table 2-2. Adjunct/Voice Terminal Compatibility — *Continued*

Adjunct	Terminals	Function
Speakerphone, S102A Speakerphone, S202A	Same as 502A Headset Adapter	Provides hands-free calling  Provides improved voice quality by adapting to room acoustics
Speakerphone, 4A Speakerphone, 203A Loudspeaker, 107	2500 Analog or stand-alone 2500	Provides hands-free calling  Provides hands-free answering. Provides hands-free calling when not used as stand-alone. Provides amplification for the received voice signal
Automatic Dialer, 2870A1	MET	Provides the capability to record and automatically dial 31 numbers

Several power supplies and connection schemes are available for providing auxiliary adjunct power when it is required. Refer to the **Adjunct Power** section later in this manual for more information on these power sources.

## Data Modules

Data modules provide an interface between the system's digital switch and Data Terminal Equipment (DTE) or Data Communications Equipment (DCE). DTE is defined as a data source or a data link or a combination of both; typical examples are data terminals and host computers. DCE is equipment that provides the functions for establishing, maintaining, and terminating a data call; a modem is an example of DCE.

An interface device between the switch and DTE or DCE is necessary because the set of data transmission rules and formats—the data protocol—at the switch is different from the protocol at the DTE or DCE. The digital ports of the switch present a DCP or ISDN-BRI interface to all devices connected to them. DCP supports simultaneous voice and data communications by multiplexing the two sets of signals into one digital stream. Digital voice terminals and some data terminals can be connected directly to the switch. But, if a data endpoint has a different protocol (EIA RS-232C or RS-232D is the most common) than the

switch, a data module must be inserted to provide compatibility. The data module provides the two-way data signal conversion and processing required between different protocols. Figure 2-3 shows a simplified diagram of the components of a typical data link.

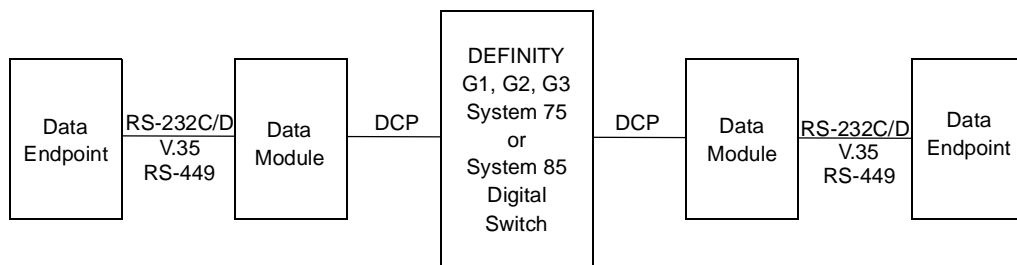

Figure 2-3. Data Link Components

The connection between a data module and a data endpoint must always have a DCE or DTE interface. If the endpoint is a DCE, the data module must present a DTE interface to it. If the endpoint is a DTE, then the data module must present a DCE interface. In general, modules are classified as DCE- or DTE-type according to the kind of data endpoint to which they are connected.

Data modules are available to match a wide variety of data needs:

- Asynchronous operation at data rates from 0.3-19.2 kbps and even, odd, mark/space, zero/one or no parity options.
- Synchronous operation at data rates of 0.3, 1.2, 2.4, 4.8, 9.6, 19.2, 56, and 64 kbps.
- Half- or full-duplex operation and internal or external timing options at the appropriate data rates.

The following data equipment is available with a DEFINITY G1, G2, and G3, a DEFINITY ECS, System 75, and System 85:

- **7400A Data Module** — In DTE mode, works with asynchronous DCE in the modem pool at data rates of 0.3-19.2 kbps, full-duplex. Supports both Hayes-compatible and D-lead modems. In DCE mode, the 7400A has Hayes<sup>®</sup>, Keyboard Dial or Answer-Only interface. Also works with asynchronous DTE where rack mounting is needed. Takes the place of MTDM or MPDM in asynchronous applications.
- **7400B and 7400B Plus Data Modules** — Works with asynchronous DTE at data rates of 0.3-19.2 kbps, full-duplex. Can be used with most 7400-series DCP voice terminals for simultaneous voice/data or

stand-alone. Emulates a Hayes-compatible modem, therefore, can be used with standard PC communications packages. Takes the place of previous DCP asynchronous data stands.

- **7400D Data Module** — Works as a DCE device between a DTE and the PBX. A DTE configuration (that is, modem pooling) is not supported, and the DCE configuration is limited to an Answer-Only-type interface option. Data rates range from 0.3 to 19.2 kbps.
- **8400B Plus** — Works as a data service link between a DTE device, a 2-wire voice terminal such as the 8400-Series voice terminals, and a DEFINITY G3V2 or later. At the desk, the 8400B Plus data module provides asynchronous communication speeds ranging from 0.3 to 19.2 kbps.
- **Modular Processor Data Module (MPDM)** — Works with synchronous DTE at data rates of 0.3-64 kbps. Also works at full- or half-duplex with internal or external timing at the appropriate data rates. Supports V.35, RS-232, and RS-449 interfaces and RS-366 Automatic Calling Unit interface at the previously mentioned rates. Video codes are an example of 56 or 64 kbps endpoints where calls are set up via the RS-366 interface. The MPDM also supports asynchronous applications, but the 7400B Plus supersedes it for applications requiring Hayes emulation and the 7400A supersedes it for remaining asynchronous applications.
- **Modular Trunk Data Module (MTDM)** — Works with a synchronous DCE in modem pool applications at data rates of 0.3-19.2 kbps. Also works at full- or half-duplex with internal or external timing at the appropriate synchronous data rates. The 7400A supersedes it for asynchronous applications.
- **7500B Data Module** — Works with asynchronous or synchronous DCE or DTE on BRI switch interface (DEFINITY G2 or 5ESS<sup>®</sup> switch only). Supports RS-232 and V.35 interfaces and RS-366 Automatic Calling Unit interface (for the RS-232 interface only).
- **ISDN Asynchronous Data Module (ADM)** — Works with asynchronous DTE as a data stand for 7500-series BRI phones (DEFINITY G2 and 5ESS switch only). Supports Hayes command set for compatibility with PC communications packages.
- **DEFINITY High Speed Link** — Works with synchronous V.35 DTE at data rates of 56 kbps half or full duplex or 64 Kbps full duplex. Supports Permanent (private line type) calls and switched calls. Switched calls can be set up using either the RS-366 or RS-232 (Hayes ATD command) interface; via DTR or Hotline dialing; or manually using the front panel call control feature. Replaces the ACCUNET<sup>®</sup> MPDM for video, LAN, CC/FEP and other high speed applications.
- **Asynchronous Data Unit (ADU)** — Works with asynchronous DTE at data rates of 0.3-19.2 kbps. Used where the user has an analog voice phone and needs basic capabilities for asynchronous terminals as opposed to

PCs. Connects to SN 238 (System 85 and DEFINITY G2 traditional modules) or TN726 (System 75 and DEFINITY G1 and G2 universal modules).

- **Multiple Asynchronous Data Unit (MADU)** — Works with asynchronous DTE at data rates of 0.3-19.2 kbps in host applications. The MADU is rack-mounted and supports busy-out. It connects to the same switch ports as the ADU.
- **2500-Series Data Service Unit (DSU), Isolating Data Interface (IDI), and Local Distribution Service Unit (LDSU)** — DCIU interface units for DEFINITY G2 and System 85.

## PC Platform Products

---

**PC/PBX Platform** — PC expansion cards and software for XT/AT bus and Micro Channel™ bus PCs in the DCP environment. Supports common, open data interface with PC/ISDN platform. Supported software includes PC/PBX Connection (for advanced phone management, access to synchronous and asynchronous hosts, and high-speed PC-to-PC communication) and E78 Plus. Works with any 7400-series phone.

**PC/ISDN Platform** — PC expansion card and software for XT/AT bus PCs in the BRI environment (DEFINITY G2 and 5ESS). Supports common, open data application interface with PC/PBX Platform. Supported software includes E78 Plus and high-speed PC-to-PC file transfer applications.

**E78 Plus/ISDN** — Software written to the open data applications interface which provides full 3270 terminal emulation and fast file transfer in IBM environments.

**3270 Data Module** — The 3270C Data module connects to an IBM® 3274 or 3174 Cluster Controller and converts DCP data from the PC platform products to the IBM Coax A format to access IBM mainframes for 3270 terminal emulation and fast file transfer.

The above PC platform products allow PC users to:

- Dial calls from the PC and use customized phone features from the keyboard, including a personalized phone directory, log of calls received and made, note-taking on calls, and phone message retrieval
- Connect to a variety of asynchronous hosts and to IBM mainframes, allowing file transfer to and from the mainframe using standard IBM file transfer protocols and the standard DCA IRMA board user interface
- Transfer files from PC to PC at rates up to 1.2 kbps over a 64 kbps facility using a PC package from Hilgraeve, Inc.
- Switch back and forth from the above capabilities to DOS programs at the touch of a key, when the PC/PBX application is run in the background

## Data Terminals

A data terminal is a workstation at which data is entered and retrieved; it communicates through lines, trunks, switches, and data modules with data endpoints such as computers and other data terminals. Some data terminals contain built-in voice capabilities similar to digital voice terminals. For detailed information on buttons, lights, and tones, refer to the general information about voice terminals at beginning of this section.

The following data terminals are available with System 75, System 85, and DEFINITY G1 and G2:

- Personal Terminal 510A (no longer manufactured)(DA)
- Personal Terminal 510D (no longer manufactured)(DA)
- Model 513 Business Communications Terminal (BCT) (no longer manufactured)(DA)
- Model 515 BCT (no longer manufactured)(DA)
- Model 610 BCT
- Model 615 MT

The 513 BCT, 610 BCT, and 615 MT, in addition to being optional units of peripheral equipment, are used in DEFINITY G1 and System 75 as System Access Terminals (SATs). The SAT is dedicated to system administration and maintenance and is located in or nearby the equipment room with the DEFINITY G1 or System 75. This manual does not cover the 513, 610, or 615 as an SAT but only as peripheral data terminals used for sending and receiving data calls.

## Technical Specifications

Technical specifications are provided for the call progress tones, external ringing tones, and indicator light signals that are used with a DEFINITY G1, G2, and G3, a DEFINITY ECS, System 75, and System 85.

### Call Progress Tones

The following call progress tones are generated by the system:

Table 2-3. Call Progress Tones

Tone	Frequency	Pattern (In ms)
Ringback Tone	440 Hz + 480 Hz	1000 on, 3000 off; repeated
Bridging Warning Tone*	440 Hz	500 on, 15000 off; repeated
Busy Tone	480 Hz + 620 Hz	500 on, 500 off; repeated

Table 2-3. Call Progress Tones — Continued

Tone	Frequency	Pattern (In ms)
Call Waiting Tones:		
Internal	750 Hz + 20 Hz	100 on; not repeated
External or Handled by Attendant	750 Hz + 20 Hz	100 on, 100 off, 100 on; not repeated
Priority Call	750 Hz + 20 Hz	100 on, 100 off, 100 on, 100 off, 100 on; not repeated
Coverage Tone	440 Hz	600 on, followed by silence; not repeated
Confirmation Tone	350 Hz + 440 Hz	100 on, 100 off, 100 on, 100 off, 100 on followed by silence; not repeated
Dial Tone	350 Hz + 440 Hz	Continuous
Intercept Tone	480 Hz & 620 Hz	250 on (480 Hz), 250 on (620 Hz); repeated
Reorder Tone	480 Hz + 620 Hz	250 on, 250 off; repeated
Call Waiting Ringback Tone	440 Hz + 480 Hz; 440 Hz	1000 on (440 Hz + 480 Hz), 200 on (440 Hz), 2800 off; repeated

\* This tone is used with the Busy Verification and Executive Override features and Service Observing when the warning tone is enabled.

## External Ringing Tones

The following external ringing tone patterns are generated by the system:

Table 2-4. External Ringing Tone Patterns

Ringling Tone	Pattern (In ms)
1	1200 on, 4000 off; repeated
2	400 on, 200 off, 600 on, 4000 off; repeated
3	200 on, 100 off, 200 on, 100 off, 600 on, 4000 off; repeated

For most currently available voice terminals, the user can select a Personalized Ringing pattern (out of eight possible ringing patterns). The tone patterns are the same as those previously described. The three tones are 530 Hz (low [L]), 750 Hz



(medium [M]), and 1060 Hz (high [H]). The tone sequences are as follows: (Each of these sequences is prefaced by a medium level tone.)

**Table 2-5. The Eight Personalized Ringing Patterns**

Ring Pattern	Tone Sequence
1	MMM
2	HHH
3	LLL
4	LHH
5	HHL
6	HLL
7	HLH
8	LHL

## Indicator Lights Signals

The following light signals are generated by the system for the attendant console and multi-appearance voice terminals:

**Table 2-6. Indicator Lights Signals**

Lamp Signal	Pattern (In ms)
Dark (Off)	Off
Lighted (On)	On
Flashing	500 on, 500 off; repeated
Fluttering	50 on, 50 off; repeated
Broken Flutter	5 cycles of 50 on, 50 off, followed by 500 off; repeated
Wink	350 on, 50 off; repeated

<b>2</b>	General Information <i>Technical Specifications</i>	2-22
----------	--	------

## Exposed Port Protection

# 3

All port packs and terminals require unique protection and grounding arrangements as defined in the checklists (*System 75 Electrical Protection, Grounding, and Exposure Checklist*, 555-200-120 and *System 85 Electrical Protection, Grounding, and Exposure Checklist*, 555-103-120). These arrangements provide an adequate barrier to the potentially damaging voltages and currents inherent in lightning and power surges present in exposed applications. Moreover, the National Electrical Code requires that an approved protector be provided on all exposed circuits.

Ports and terminals that utilize facilities that are subject to disturbances from lightning, ground potential rises (GPR), or possible contact or induction from electrical power sources or circuits in excess of 300 volts (RMS) to ground are classified as exposed. Any ports or terminals served by such exposed facilities are classified as exposed and require protection at both the port and terminal ends. The checklists contain flowcharts that are beneficial in determining exposure status and tables to determine the type of protector required.

## Out-of-Building Campus Stations

An out-of-building campus station is a telephone or voice terminal that is not physically located in the same building as the equipment room, but is located on the same property. Both analog telephones and digital voice terminals can be used as out-of-building stations.

Carbon block, or equivalent, protection is required at both building entrances for analog out-of-building stations. Sneak current protection is also required. Protection can be provided by a 4-type protector or a 3-type protector plus a separate sneak current protector. The 4-type protector is equipped with a heat coil for sneak current protection. The 4-type primary protector is the preferred device.

**3** Exposed Port Protection  
*Out-of-Building Campus Stations*

3-2

Protection is required at both entrances for digital out-of-building voice terminals. There are two different types of protectors that can be used to protect digital voice terminals and digital line circuit packs in an out-of-building environment: the 4C3S-75 Enhanced Protector and the ITW Linx Enhanced Protector.

 **NOTE:**

The 4C3S-75 Enhanced Protector may only be used on Vintage 14 or newer TN754 Circuit Packs. The 4C3S-75 can be used on all vintages of the TN754B Circuit Pack. The ITW Linx Enhanced Protector may be used on all Vintages of the TN754 and TN754B Circuit Packs.

The 4C3S-75 Enhanced Protector is equipped with a heat coil for sneak current protection and the ITW Linx Enhanced Protector is equipped with replaceable fuses for sneak current protection.

The maximum range for out-of-building voice terminals is 3,400 feet when using 24 AWG wire and 2,200 feet when using 26 AWG wire. The range can be extended to 5,000 feet (24 AWG) or 4,000 feet (26 AWG) with the use of a Data Link Protector (DLP). The DLP is an isolating transformer used to remove phantom power on the switch side and reintroduce it on the terminal side. When a DLP is used, the voice terminal must be locally powered by an external power supply or through the AC power cord provided with some of the 7400 series voice terminals. The DLP is installed on the equipment side of the protection in both buildings. In high lightning areas, the DLP may also be installed to provide the maximum degree of protection and reliability.

## Recommended Protectors and IROB Protection

Table 3-1 shows the recommended protectors for the DEFINITY G1, G2, and G3, DEFINITY ECS, System 75, and System 85. Table 3-2 shows the in-range, out-of-building (IROB) protection for DEFINITY line circuits and terminals.



**CAUTION:**

*The following circuit pack and terminal arrangements are not allowed to be installed in an exposed environment:*

1. 7300 Series connected to the TN762B or ANN17 Circuit Pack
2. MET terminals connected to the TN735 Circuit Pack
3. Analog terminals connected to the TN746 Circuit Pack

**Table 3-1. Recommended Protectors**

Primary	Primary (with Heat Coil)	Enhanced Primary	Secondary
3B1A (carbon)	4B1C (carbon)	4C3S-75 (solid state)	79A Fuse
3B1E-W (wide-gap gas tube)	4B1E-W (wide-gap gas tube)	ITW Linx (gas tube avalanche suppress)	SCP-1
3C1S (solid state)	4C1S (solid state)		

**Table 3-2. IROB Protection**

Circuit Packs	Terminal	Required Protector*
SN224	7203, 7205, MET	EP
SN228B, SN229	2500 Series, 2500DMGC, 7100 Series	P <sup>1</sup>
TN742, TN746B, TN769	500 Series, 2500 Series, 7100 Series	P <sup>1</sup>
SN270	7400 Series	EP
TN754	7400 Series	(ITW) <sup>2</sup>
TN754, V14	7400 Series	EP <sup>3</sup>
TN556	T. Term	EP and P <sup>4</sup>

**\* Key to Abbreviations:**

P = Primary; EP = Enhanced Primary

**Notes:**

1. Primary protection with heat coils for sneak protection are coded with the number 4 as the first numeric. DEFINITY ports require sneak current protection for IROB terminal installations.
2. The TN754, V1 through V13 may be installed with either the DLP and primary protector or the ITW Linx Enhanced Primary protector. These vintages may not be installed with the 4C3S-75 Enhanced Primary protector.
3. The 4C3S-75 Enhanced Protector may only be used on Vintage 14 or newer TN754 Circuit Packs. The ITW Linx Enhanced Protector may be used on all Vintages of the TN754 Circuit Pack.
4. The TN556 Circuit Pack requires Enhanced Primary protection at the port and Primary (3- or 4-type) protection at the terminal.

For more information on exposed port protection, refer to:

- *DEFINITY Communications System Generic 1 and Generic 3 Wiring*, 555-204-111
- *DEFINITY Communications System Generic 2 and System 85 Wiring*, 555-104-630

## Adjunct Power

# 4

---

Power for several of the adjuncts must be provided locally at the voice terminal or from a satellite closet through the terminal wiring. The following power supplies are currently recommended:

- The 1151A1 Power Unit and the 1151A2 Power Unit with Battery Holdover have replaced the MSP-1 (WP92464L1) Power Supply, the KS-22911 L1/2, 329A, and 353A DC power supplies, and the 2012D AC transformer. The 1151A1 and 1151A2 with Battery Holdover can be used to supply local power to ISDN-T 65xx, 75xx, and 85xx series voice terminals connected to a DEFINITY Communications System Generic 1, Generic 2, Generic 3, a DEFINITY ECS, and the DCP 7444 and 8434/8434DX voice terminals which need auxiliary power for their vacuum fluorescent displays. You will also need auxiliary power if you are using a 6400 Series telephone or an 8411 voice terminal or if you have a ZE801A or an XM24 expansion module connected to your voice terminal or telephone. These power units can also supply auxiliary power to adjunct equipment such as the S201A, CS201A, or SoundPoint speakerphones or a 500A1 Headset Adapter attached to any currently manufactured analog, DCP, or ISDN-T voice terminal equipped with an Adjunct jack. For more information on the MSP-1 and the newer 1151A1 and 1151A2 power supplies, see the short section with connection diagrams later in this section.
- The ISDN 1145B1 Bulk Power Unit, 1146B Power Distribution Unit, and the 2.5/5.0 A.H. back-up batteries provide an uninterruptible power source for ISDN telephones and terminals, NT1s, terminal adjuncts, and other customer premises equipment. During AC power interruptions, batteries are automatically switched on to provide continuous power to the load.

The distribution of power to the terminal equipment is provided by the 1146B distribution unit. The 1146B provides 32 standard 110 connections to the load with overcurrent protection and alarm lights. The 1145B1/1146B power arrangement is compact (measuring only 6.5 inches deep), lightweight, plastic enclosed, and designed for easy wall- or rack-mounting.

During normal operation, the power supply/charger provides DC power to the load via the distribution unit while maintaining the battery in a fully charged condition. The power system continuously monitors systems conditions with the status displayed on the front panel of the power supply and distribution unit.

The following power supplies and transformers are NO LONGER recommended. They have been replaced by the 1151A1 and 1151A2 power units and the 1145B1 bulk power unit described above.

- 2012D AC transformer — can be used locally or in a satellite closet to power a single 18 volt headset adapter or speakerphone.
- KS-22911, L2 DC power supply — can be used locally or in a satellite closet to power a headset adapter or speakerphone plus one additional adjunct. This unit has a 48 volt power output of 10 watts.
- KS-21239, L4, L5 AC transformer — can be used locally or in a satellite closet to power a single 24 volt speakerphone-dialer.
- PS3081096 AC transformer — can be used locally or in a satellite closet to power the 24 V S201A or S203A speakerphones.
- 329A DC power supply — can be used locally or in a satellite closet and is capable of supplying power to any number of adjuncts that may be added to a digital voice terminal. This unit has a power output of 25 watts.
- 346A modular bulk DC power supply — can be used in a satellite closet only and is capable of supplying power to any number of adjuncts that may be added to a digital voice terminal. This unit provides switch-selectable options for four outputs at 10 watts or two outputs at 20 watts.
- 85B1-49 power unit — can be used locally or in a satellite closet to power the 4A speakerphone.
- 95B1 power unit — can be used locally or in a satellite closet to power a 2870A1 automatic dialer.
- 353 DC Power Supply — can be used locally only. It is designed to supply power to ISDN-BRI stations and their adjuncts. It has a power output of 12 watts.
- 945 Bulk DC Power Supply — can be used in a satellite closet only. It is designed to power ISDN-BRI stations and their adjuncts. It can optionally be equipped with a battery to provide terminal operation for a limited time in case of an AC power failure. Up to 26 ISDN-BRI terminals can be supported by the 945 power supply.



## Information on the Older Power Supplies

---

The following diagram (Figure 4-1) shows the connections with the older power supplies including the MSP-1.



**NOTE:**

The 1151A1 and 1151A2 replace the MSP-1, the KS-22911 L1/2, 329A, the 353A DC power supplies, and the 2012D AC transformer.

## The Power Supplies Prior to the MSP-1

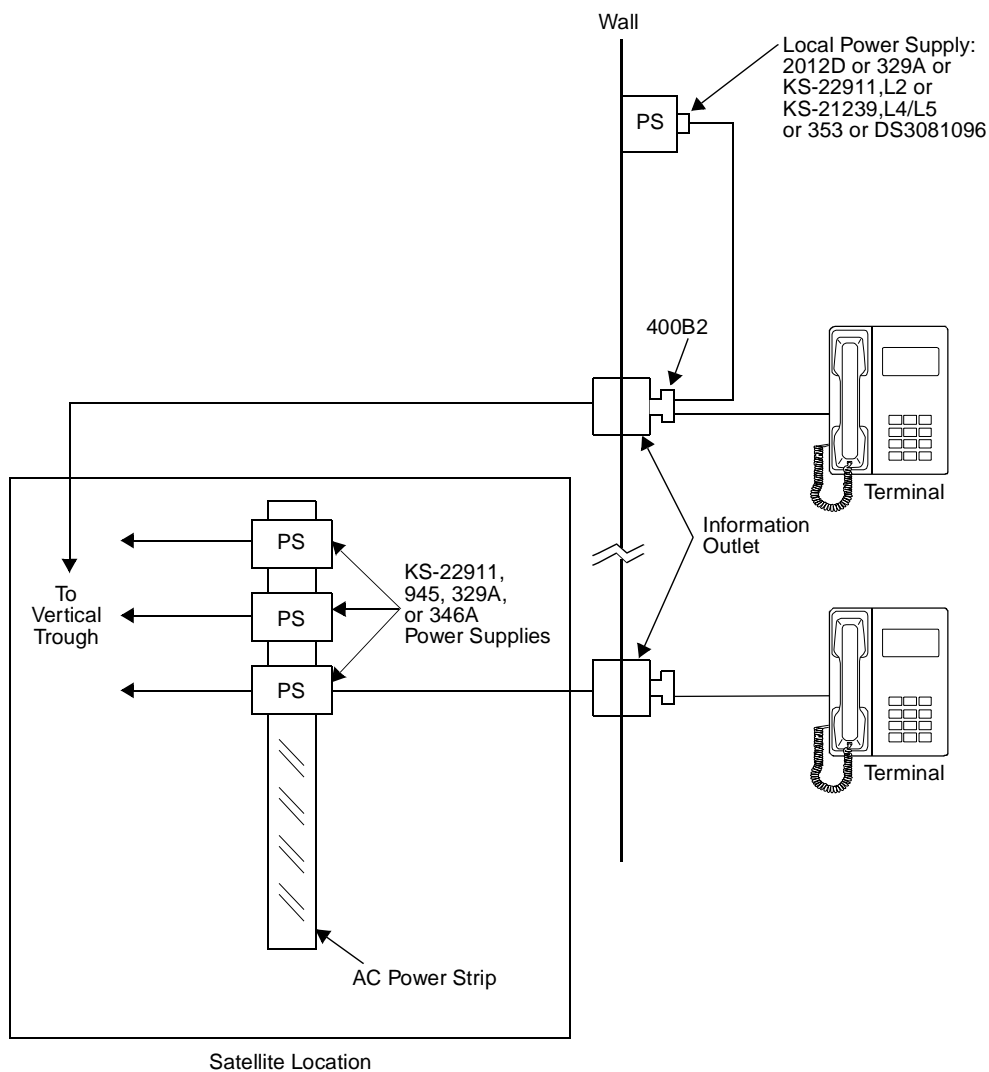

Figure 4-1. Local and Satellite Power Sources for Voice Terminals Adjuncts

**4** Adjunct Power*Information on the Older Power Supplies*

4-5

One of these power supplies must be used for each voice terminal equipped with one or more adjuncts. Each of these power supplies (except the 95B1) has a maximum cable distance of 250 feet (76 m) between the power supply and the adjunct(s). The maximum cable distance for the 95B1 is 150 feet (45m). Voice terminal adjuncts and modules are not operational during interruptions of commercial AC power unless their power supplies are also powered through standby power of other essential AC power service.

The 329A and 346A power supplies clustered in a satellite closet are normally mounted on AC power strips. Power to these strips is provided from a dedicated 120 volt AC, 60-Hz, 20-ampere circuit breaker and feeder either directly or through a 543A telephone power unit. The 543A unit provides an inductive filter to limit inrush current on the feeder. It comes equipped with an AC power cord which plugs into the dedicated feeder and provides four receptacles for AC power strips.

The 945 bulk power system is usually rack mounted and is intended to be located in an equipment room or satellite closet. It is optionally made up of the following components:

- 945-1 bulk power supply unit.
- 945-2 battery reserve unit.
- 945-3 system enclosure, equipped with one or two 945-1 and/or a 945-2.
- 945-4 single enclosure for 945-1 unit.

Several power supplies and connection schemes are available for providing auxiliary adjunct power when it is required. Regardless of its source, auxiliary power is introduced into a pair of spare leads in the individual voice terminal's line, at some wiring interface. The auxiliary power is fed into the terminal on the mounting line cord. From the terminal, power is distributed to the adjunct(s). An auxiliary power source is usually mounted in a satellite closet or adjacent to the voice terminal's wall jack.

## **The MSP-1 Power Supply**

---

The MSP-1 (WP92464L1) Power Supply can be used to supply local power to ISDN-T 65xx, 75xx, and 85xx series voice terminals connected to a DEFINITY Communications System G1, G2, and G3, a DEFINITY ECS, and to the DCP 7444 and 8434/8434DX voice terminals which need auxiliary power for their vacuum fluorescent displays. The MSP-1 can also supply auxiliary power to adjunct equipment such as the S201A and CS201A speakerphones or a 500A Headset Adapter attached to any currently manufactured analog, DCP, or ISDN-T voice terminal equipped with an Adjunct jack.

**CAUTION:**

*The MSP-1 Power Supply can be used only with telecommunications equipment, indoors, in a controlled environment.*

4 Adjunct Power

Information on the Older Power Supplies

4-6

**⇒ NOTE:**

One power supply will support one telephone with or without an adjunct.

The maximum loop range between the telephone and the power supply is 250 feet.

This power supply replaces the KS-22911-L1/2, 329A, and 353A DC Power Supplies and the 2012D AC Transformer.

The MSP-1 power supply has a single output of -48 volt DC, 0.4 amperes, and can operate from either a 120 VAC 60 Hz power source (105 to 129 VAC) or a 220/230/240 50 Hz power source (198 to 264 VAC). Input voltage selection is automatic; that is, the power supply adjusts itself for the type of input voltage. The output capacity is 19.2 watts.

### Contents of the MSP-1 Package (and Comcodes)

The MSP-1 package includes the following items: (Comcodes are provided for additional orders)

- One MSP-1 power supply (Comcode: 406743419)
- One 6-foot, 7-inch input power cord (Comcode: 403271117)
- One 7-foot D8W cord (Comcode: 103786786)
- Double-sided adhesive fastener strips for mounting the power supply on a flat vertical surface (Comcode: 406824789)
- Printed instructions

### Connecting the Power Supply

The power output is provided through 2 modular jacks on the power supply. These jacks are labeled, from left to right:

Phone	Other	Line
-7 +8	-2 +5	

The - and + numbers under "PHONE" and "OTHER" refer to the pins on which power is present and the polarity of that power.

The PHONE and LINE jacks are 8-pin female non-keyed 657-type jacks that can accept D4, D6, and D8 modular plug cables. The OTHER jack is a 6-pin female non-keyed 657-type jack.

The following local powering arrangements, shown in Figures 4-2 and 4-3, can be used with the MSP-1 power supply.

4 Adjunct Power

Information on the Older Power Supplies

4-7

- Figure 4-2 shows the local powering arrangement for: ISDN voice terminals; the DCP 7444 and 8434DX voice terminals' VF displays; and adjuncts connected to all telephones except the 8102.
- Figure 4-3 shows the local powering arrangement for adjuncts connected to the 8102 telephone.



**NOTE:**

The type of cord(s) needed to make these connections are designated in each drawing.

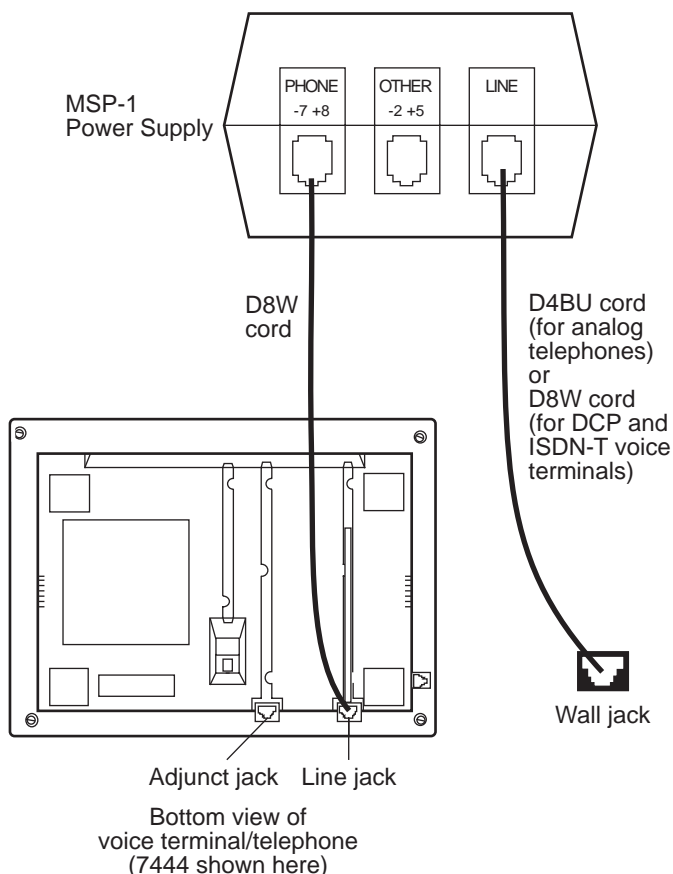

**Figure 4-2. Local Powering Arrangement (Using the MSP-1) for: ISDN-T Voice Terminals; the DCP 7444 and 8434/8434DX Voice Terminals (for their VF Displays); and Adjuncts Connected to All Telephones Except the 8102**

4 Adjunct Power

The 1151A1 and 1151A2 Power Units

4-8

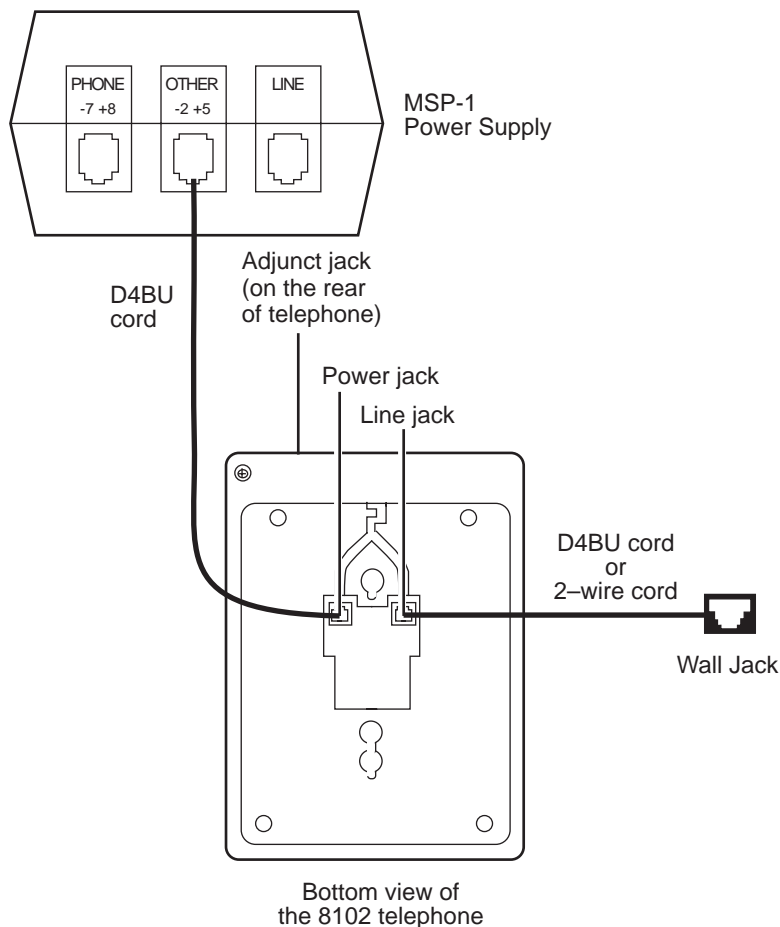

Figure 4-3. Local Powering Arrangement (Using the MSP-1) for Adjuncts Connected to the 8102 Analog Telephone

## The 1151A1 and 1151A2 Power Units

The 1151A1 power supply is a single output 48 volt DC, 20 watt power supply. The 1151A1 operates from nominal AC input voltage (85 to 132 or 176 to 264) 50 or 60 Hz. This power supply can be desk-mounted and wall-mounted.

The 1151A2 power supply also is a single output 48 volt DC, 20 watt power supply. However, this power supply has battery holdover. The power supply operates from nominal AC input voltage (85 to 132 or 176 to 264) 50 or 60 Hz. Input voltage selection is automatic; that is, the power supply adjusts itself for the

4 Adjunct Power

The 1151A1 and 1151A2 Power Units

4-9

type of input voltage. When AC power fails, the battery will provide 15 minutes of holdover at full load (20 watts) or 8 hours at light load (2 watts).

The 1151A1 and 1151A2 power supplies can be used to supply local power to ISDN-T 65xx, 75xx, and 85xx series voice terminals connected to a DEFINITY Communications System G1, G2, and G3, a DEFINITY ECS, and to the DCP 7444 and 8434/8434DX voice terminals which need auxiliary power for their vacuum fluorescent displays. You also need auxiliary power if you are using an 8411 voice terminal or if your voice terminal has a ZE801A or XM24 expansion module connected to it. These power supplies can also supply auxiliary power to adjunct equipment such as the S201A, CS201A, or SoundPoint speakerphones or a 500A1 Headset Adapter attached to any currently manufactured analog, DCP, or ISDN-T voice terminal equipped with an Adjunct jack.



**CAUTION:**

*The 1151A1 and 1151A2 Power Supplies can be used only with telecommunications equipment, indoors, in a controlled environment.*



**NOTE:**

One 1151A1 or 1151A2 Power Supply will support two or more telephones with or without an adjunct that does not exceed 20 watts of power.

The maximum loop range between the telephone and the power supply is 250 feet.

Both the 1151A1 and the 1151A2 power supply have a green light (labeled **POWER ON**) that shows the unit has power on the PHONE mod jack pins 7 and 8 when AC power is applied.

The 1151A2 power supply also has a yellow light that shows that the battery is charging when AC power is applied. When the battery is fully charged, the yellow light is off.

## Contents of the 1151A1 and 1151A2 Packages (and Comcodes)

---

The 1151A1 and 1151A2 packages include the following items: (Comcodes are provided for additional orders)

- One 1151A1 power supply (Comcode: 107787129) or one 1151A2 power supply (Comcode: 107787111)
- One power cord NEMA 5-15P
- One 7-foot D8W cord (Comcode: 103786786)
- Printed instructions

**4** Adjunct Power

*The 1151A1 and 1151A2 Power Units*

4-10

## **Connecting the Power Supply**

---

The power output is provided through 1 modular jack on the power supply. These jacks are labeled, from left to right:

<b>Phone</b>	<b>Line</b>
-7 +8	

The - and + numbers under "PHONE" refer to the pins on which power is present and the polarity of that power.

The PHONE and LINE jacks are 8-pin female non-keyed 657-type jacks that can accept D4, D6, and D8 modular plug cables.

The following local powering arrangement, shown in Figures 4-4, can be used with the 1151A1 and 1151A2 power supplies.



4 Adjunct Power

The 1151A1 and 1151A2 Power Units

4-11

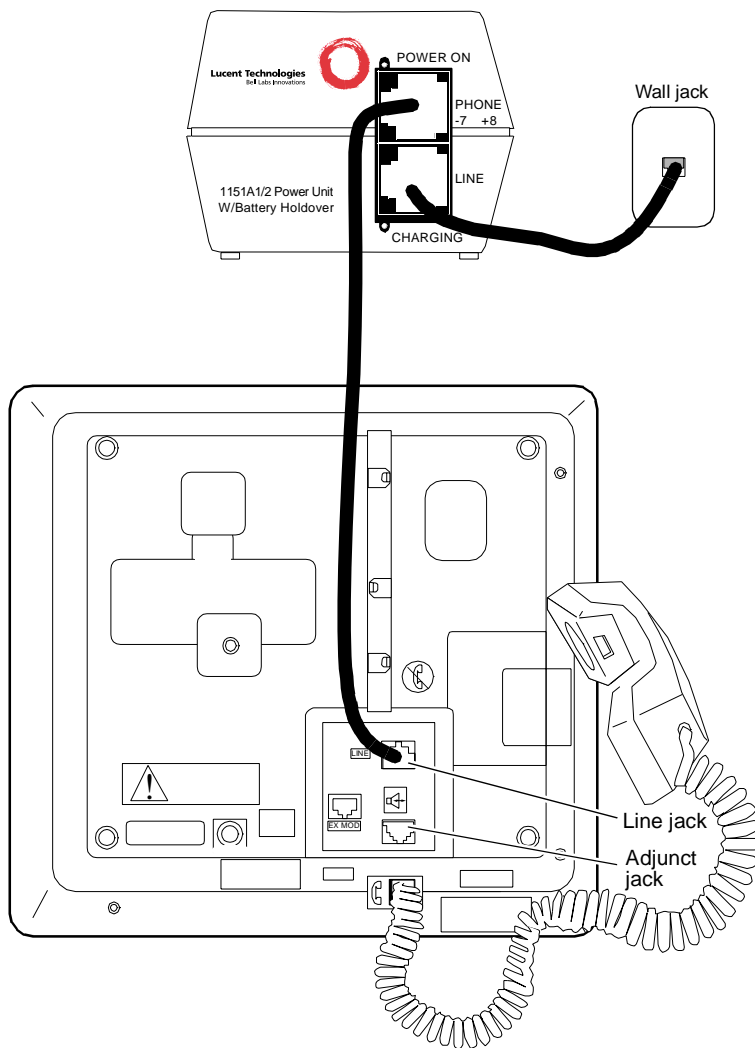

Figure 4-4. Local Powering Arrangement (Using the 1151A1/A2) for: ISDN-T Voice Terminals; the DCP 7444 and 8434/8434DX Voice Terminals (for their VF Displays); the 8411; any 8400 or 6400 Series Telephone with an Attached Expansion Module; and Adjuncts Connected to All Telephones Except the 8102

<b>4</b>	Adjunct Power <i>The 1151A1 and 1151A2 Power Units</i>	4-12
----------	---	------

## Administration

# 5

---

This section contains some of the information necessary to administer the different voice terminals connected to a DEFINITY Communications System Generic 1, Generic 2, and Generic 3, a DEFINITY Enterprise Communications Server (ECS), and to a System 75, or System 85. It also provides the caveats required when administering some of the newer voice terminals to the older systems. Other administration information for the DEFINITY G1 and G3 or System 75 is provided in the DEFINITY G1 and G3 and System 75 Implementation and Administration manuals. The administration information for DEFINITY G2 and System 85 is provided in the *System 85 and DEFINITY G2 Translation Service Manual*.

### NOTE:

The sections of this manual which describe the newer voice terminals provide detailed information on administering that voice terminal. In most cases, diagrams of the button numbering schemes are also provided. For example, if you want to administer an 8410 voice terminal, see the section on the 8410 Voice Terminal under the tab labeled **8400 Series**.

## Aliasing

---

When some of the newer voice terminals are used with some older versions of the switches, the administration procedures of the switch does not allow for the use of the new terminals. These new terminals must be administered using the administration procedures of a similar older terminal. This is called “aliasing” a set.

When aliasing is used to administer a voice terminal, often the “old” screen used in administering buttons and features displays more buttons than can actually be assigned to the new terminal. These differences are provided in this section also.

The following tables list the aliases used in administering the terminals. If the terminal you are administering is not listed in the tables, then it is administered as itself in all versions of the switch.

**Table 5-1. DEFINITY G1 and G3, DEFINITY ECS, and System 75 Voice Terminal Administration**

Voice Terminal	System			
	S75 R1V1	S75 R1V2	S75 R1V3	G1 and G3
8101/8102/8110	2500 with Message Waiting			
6201	2500			
6210/6220/6230	2500 with Message Waiting			
6402, 6402D, 6408, 6408+, 6408D, 6408D+, 6416D+, 6424D+	X			Administered as itself on DEFINITY ECS Release 6.1 (or later)
7102A			7101A	
7104A	7101A or 2500*	S		
7203H	X			
7205H	X			
"MERLIN"† SMALL	7303S			
"MERLIN" MEDIUM	7305S			
"MERLIN" LARGE	7305S			
7401D	7403D			S
7401 Plus	7403D			7401D
7402 Plus	7403D		7410D	
7406	7405D DD	S		
7406BIS	7405D	S		
7406 Plus	7405D	7406D or 7406BIS		
7407D	7405D DD	S		
Enhanced 7407D	7405D DD	7407D		
7407 Plus	7405D DD	7407D		

\* If equipped with a message waiting adjunct, administer as a 7101A; otherwise, administer as 2500.

† MERLIN Communications System

S = Administered as Self  
 X = Not Allowed  
 DD = Digital Display Module

**Table 5-1. DEFINITY G1 and G3, DEFINITY ECS, and System 75  
 Voice Terminal Administration — *Continued***

Voice Terminal	System			
	S75 R1V1	S75 R1V2	S75 R1V3	G1 and G3
7410	7403D			
7410 Plus	7403D			7410D
7434	7405D			
7444	7405D DD	7405D or 7407D*		7434D or 7407D*
8403	7405 <sup>†</sup>			
8405B/8405B Plus	7403	7410 <sup>‡</sup>		
8405D/8405D Plus	7403	7410 <sup>‡</sup>		
8410B	7403	7410 <sup>§</sup>		
8410D	7403	7410 <sup>§</sup>		
8411B	7403	7410 <sup>¶</sup>		
8411D	7403	7410 <sup>¶</sup>		

\* CAVEATS for administration of the 7444 voice terminal:  
 If the 7444 voice terminal is administered as a 7405D or a 7407D, the following caveats apply:

- Only 10 call appearance buttons can be administered with two lights, a red and a green light.
- If the voice terminal is administered as a 7407D, the S1 switch on the back of the 7444 voice terminal must be in the OFF position.

When the 7444 voice terminal is administered as a 7405D or a 7434 voice terminal, the following caveats apply:

- The S1 switch on the back of the 7444 voice terminal must be in the ON position.
- Only one line of the display will show switch-related information.

When a 7444 is administered as a 7434, DEFINITY G1 allows a maximum of 10 appearances of the primary line while DEFINITY G2 allows a maximum of 12 appearances. Each switch handles appearances of other lines (that is, lines used in Bridging, Call Pickup, etc.) in a different manner. Information about administering these appearances can be found in switch documentation and help screens.

† If the 8403 is connected to a DEFINITY G3V3 (and later), the 8403 can be administered as itself.

‡ If the 8405B or 8405B Plus is connected to a DEFINITY G3i or G3r, it can be administered as a 7410 Plus. If the 8405B or 8405B Plus is connected to a DEFINITY G3V3 (or later), the set can be administered as an 8410B. If the 8405D or 8405D Plus is connected to a DEFINITY G3V3 (or later), the set can be administered as an 8410D.

§ If the 8410B is connected to a DEFINITY G3i or G3r, it can be administered as a 7410 Plus. If the 8410B or 8410D is connected to a DEFINITY G3V3 (or later), the set can be administered as itself.

¶ If the 8411B is connected to a DEFINITY G3i or G3r, it can be administered as a 7410 Plus. If the 8411B is connected to a DEFINITY G3V3 (or later), the set can be administered as an 8410B. If the 8411D is connected to a DEFINITY G3V3 (or later), the set can be administered as an 8410D.

DD = Digital Display Module

*Continued on Next Page*

**Table 5-1. DEFINITY G1 and G3, DEFINITY ECS, and System 75  
 Voice Terminal Administration — Continued**

Voice Terminal	System			
	S75 R1V1	S75 R1V2	S75 R1V3	G1 and G3
8434/8434DX (for extra features)*	7405+D+F			
8434/8434DX (for additional coverage)*	X			7434+D
602 CALLMASTER	X	X	S	
CALLMASTER II and III	X	X	602 CALLMASTER	
7505 ISDN	X			S
7506 ISDN	X			S
7507 ISDN	X			S
8503T	X			S
8510T	X			S†
8520T	X			S
MDC 9000	7303S Hybrid‡			
MDW 9000	7303S Hybrid‡			
MDW 9031DCP	8410D			

\* CAVEATS for administration of the 8434 voice terminal:

The 8434 and 8434DX may be aliased as a 7405+D+F to support all system features. However, in this case, while all the call appearance/feature buttons AND the softkey features will be functional, there can be a maximum of only 10 call appearances. On the 7405, the Display Module is a 1-line display, and thus the 1-line display option should be selected. On some systems, the 8434 and 8434DX can be aliased as a 7434+D or a 7444 to support coverage. In this case, there can be up to 34 call appearances (including bridged call appearances), but the 15 softkey features will NOT be functional because the Feature Key Module is not allowed with the 7434 or 7444. On the 7434, the Display Module is a 1-line display, and thus the 1-line display option should be selected. If the set is administered as a 7444, it can be optioned for a 2-line display.

An 8434 or 8434DX connected to a DEFINITY G3V2 can be administered as a 7444; an 8434 or 8434DX connected to a DEFINITY G3V3 (or later) can be administered as itself.

† An 8510T voice terminal connected to a DEFINITY G1 or G3 can be administered as itself, but an 8510 data terminal must be administered as a 7507.

‡ A MDC 9000 Cordless Telephone or a MDW 9000 Wireless Telephone connected to a DEFINITY G3V3 (or later) can be administered as itself.

S = Administered as Self

X = Not Allowed

+D = with Display Module

+F = with Feature Key Module

**Table 5-2. DEFINITY G1 and G3, DEFINITY ECS, and System 75 Terminal and Module Administration**

PCs and Digital Modules	System			
	S75 R1V1	S75 R1V2	S75 R1V3	G1 and G3
PC/PBX Platform	7405D DD and DM	PC		
MPDM	S			
MTDM	S			
7400A DM	PDM or TDM (modem pool only)			S
7400B and 7400B Plus DM	PDM (data only) or DM (voice and data)			S
High Speed Link	PDM			
3270A DCP	PDM			
3270C DCP	PDM			
3270T DCP	PDM			
PC/ISDN Platform	X	X	X	X

S = Administered as Self  
X = Not Allowed  
PC = Personal Computer  
DD = Digital Display Module  
DM = Data Module  
TDM = Trunk Data Module  
PDM = Processor Data Module



Table 5-3. DEFINITY G2 and System 85 Voice Terminal Administration

Voice Terminal	System				
	S85 R2V1	S85 R2V2	S85 R2V3	S85 R2V4	G2
500			A		
2500			A		
2500 YMGK			A		
8101/8102/8110			A		
6201/6210/6220/6230					
7101A			A		
7102A			A		
7102 Plus			A		
7103A			A		
7104A			A		
10 MET			7203H		
20 MET			7205H		
30 MET			7205H		
"MERLIN" SMALL			X		
"MERLIN" MEDIUM			7303S		
"MERLIN" LARGE			7305S		
7401D		7403D			S
7401 Plus		7403D			7401D
7402 Plus		7403D			7410D
7404	7403D DM			S	
7406D		7405D DD			S
7406BIS		7405D DD			S
7406 Plus		7405D DD			7406D or 7406BIS
7407D	7405 DD			S	
Enhanced 7407D	7405D DD		7407D		
7407 Plus	7405D DD		7407D		

X = Not Allowed  
 A = Administered as Analog On-premises or Off-premises  
 S = Administered as Self  
 DD = Digital Display Module  
 DM = Data Module (DTDM or ADS)

**Table 5-3. DEFINITY G2 and System 85 Voice Terminal Administration — Continued**

Voice Terminal	System				
	S85 R2V1	S85 R2V2	S85 R2V3	S85 R2V4	G2
7410D	7403D				S
7410 Plus	7403D				7410D
7434D	7405D				S
7444	7405D DD	7405D DD or 7407D*			7434D or 7407D*
8403	7405				
8405B/8405B Plus	7403				7410D
8405D/8405D Plus	7405+D				
8410B	7403				7410D
8410D	7405+D				
8411B	7403				7410D
8411D	7405+D				

\* CAVEATS for administration of the 7444 voice terminal:

If the 7444 voice terminal is administered as a 7405D or a 7407D, the following caveats apply:

- Only 10 call appearance buttons can be administered with two lights, a red and a green light.
- If the voice terminal is administered as a 7407D, the S1 switch on the back of the 7444 voice terminal must be in the OFF position.

When the 7444 voice terminal is administered as a 7405D or a 7434 voice terminal, the following caveats apply:

- The S1 switch on the back of the 7444 voice terminal must be in the ON position.
- Only one line of the display will show switch-related information.

When a 7444 is administered as a 7434, DEFINITY G1 allows a maximum of 10 appearances of the primary line while DEFINITY G2 allows a maximum of 12 appearances. Each switch handles appearances of other lines (that is, lines used in Bridging, Call Pickup, etc.) in a different manner. Information about administering these appearances can be found in switch documentation and help screens.

S = Administered as Self  
 DD = Digital Display Module

*Continued on Next Page*

**Table 5-3. DEFINITY G2 and System 85 Voice Terminal Administration — Continued**

Voice Terminal	System				
	S85 R2V1	S85 R2V2	S85 R2V3	S85 R2V4	G2
8434/8434DX (for extra features)*	7405+D+F				
8434/8434DX (for additional coverage)*	X				7434+D
602 CALLMASTER	X	S			
CALLMASTER II and III	X	602 CALLMASTER			
7505 ISDN	X				S
7506 ISDN	X				S
7507 ISDN	X				S
8503T	X				7505
8510T	X				7507
8520T	X				7507
MDC 9000	7303S Hybrid				
MDW 9000	7303S Hybrid				
MDW 9031	8410D				

\* CAVEATS for administration of the 8434 voice terminal:

The 8434 may be aliased as a 7405+D+F to support all system features. However, in this case, while all the call appearance/feature buttons AND the softkey features will be functional, there can be a maximum of only 10 call appearances. On the 7405, the Display Module is a 1-line display, and thus the 1-line display option should be selected.

On some systems, the 8434 can be aliased as a 7434+D or a 7444 to support coverage. In this case, there can be up to 34 call appearances (including bridged call appearances), but the 15 softkey features will NOT be functional because the Feature Key Module is not allowed with the 7434 or 7444. On the 7434, the Display Module is a 1-line display, and thus the 1-line display option should be selected. If the set is administered as a 7444, it can be optioned for a 2-line display.

X = Not Allowed

A = Administered as Analog On-premises or Off-premises

S = Administered as Self

**Table 5-4. DEFINITY G2 and System 85 Terminal and Module Administration**

Display Terminals and Digital Modules	System				
	S85 R2V1	S85 R2V2	S85 R2V3	S85 R2V4	G2
PC/PBX Platform	7405D DD and DM	PT 510D		PC	
BCT 513	X		EIA PORT		
MPDM	PDM				
MTDM	TDM				
7400A DM	PDM or TDM (modem pool only)				S
7400B and 7400B Plus DM	PDM (data only) or DM (voice and data)				S
7500B DM	X				S
High Speed Link	PDM				
3270A DCP	PDM				
3270C DCP	PDM				
3270T DCP	PDM				
PC/ISDN Platform	X				GTA

S = Administered as Self

X = Not Allowed

PC = Personal Computer

DD = Digital Data Module

DM = Data Module

PDM = Processor Data Module

TDM = Trunk Data Module

GTA = Generalized Terminal Administration (see System 85 and DEFINITY G2  
Button and Feature Caveats section)

## Button and Feature Caveats

### System 75, DEFINITY G1 and G3, and DEFINITY ECS

Table 5-5. Button and Feature Caveats for DEFINITY G1 and G3 and System 75

Terminal	Aliased As	Switch Release	Buttons that Do NOT Exist*	Do NOT Assign Features to Button(s)
7401D	7403D	R1V1—R1V3	10	—
7406D01A— 7406D04A	7405D (See Note 1)	R1V1	6—10, 19—24	—
7406D05A, 7406D06A	7405D (See Note 1)	R1V1	6—10, 19—24	2, 3 (See Note 2)
	Self	R1V2—R1V3, G1	—	2, 3 (See Note 2)
8405 (call appearance/ feature buttons)	8410	DEFINITY G3V3 or later	6—10	—
CALLMASTER II and III	602 CALLMASTER	R1V3 (See Note 3)	7—10	22 and 28

\* Do not assign features to these buttons.

**Note 1:**

7406D02A, 7406D04A, and 7406D06A aliased as 7405D;  
 7406D02A, 7406D04A, and 7406D06A with 7400B Plus aliased as 7405D with DM;  
 7406D01A, 7406D03A, and 7406D05A aliased as 7405D with DD;  
 7406D01A, 7406D03A, and 7406D05A with 7400B Plus aliased as 7405D with DM and DD;  
 7406D01A and 7406D02A with Z703A DSU aliased as 7405D with DM and DD.

**Note 2:**

Reserved for Speaker and Mute.

**Note 3:**

Not supported in earlier releases.

**Note 4:**

These buttons are used for the Log in and Release features.

## 5 Administration

## Button and Feature Caveats

5-12

**System 85 and DEFINITY G2****Table 5-6. Button and Feature Caveats for DEFINITY G2 and System 85**

Terminal	Aliased As	Switch Release	Buttons that Do NOT Exist*	Do NOT Assign Features to Button(s)
7401D	7403D	R2V1—R2V3	12	—
7406D01A— 7406D04A	7405D (See Note 1)	R2V1—R2V3	8—12, 31—36	—
7406D05A, 7406D06A	7405D (See Note 1)	R2V1—R2V3	8—12, 31—36	14, 15 (See Note 2)
	Self	R2V4—G2	—	14, 15 (See Note 2)
CALLMASTER II and III	602 CALLMASTER	R2V2—R2V4 (See Note 3)	9—12	24 and 30 (See Note 4)

\* Do not assign features to these buttons.

**Note 1:**

7406D02A, 7406D04A, and 7406D06A aliased as 7405D;  
 7406D02A, 7406D04A, and 7406D06A with 7400B Plus aliased as 7405D with DM;  
 7406D01A, 7406D03A, and 7406D05A aliased as 7405D with DD;  
 7406D01A, 7406D03A, and 7406D05A with 7400B Plus aliased as 7405D with DM and DD;  
 7406D01A and 7406D02A with Z703A DSU aliased as 7405D with DM and DD.

**Note 2:**

Reserved for Speaker and Mute.

**Note 3:**

Not supported in R2V1.

**Note 4:**

These buttons are used for the Log In and Release features.

**PC/ISDN Platform (DEFINITY G2).** To administer the PC/ISDN Platform, the Generalized Terminal Administration (GTA) capability of DEFINITY G2 must be used. Below is an overview of how to administer it. See the *PC/ISDN Installation and Reference Manual* for detailed instructions.

**PC/ISDN Administration on DEFINITY G2.** Ordinary BRI terminals used with DEFINITY G2 require initialization. They also support Maintenance Information Messages (MIMs). Because PC/ISDN supports neither MIMs nor terminal initialization, the system administrator must have created a *terminal type* for each type of terminal being used with PC/ISDN. If the terminal is to have an associated display, the display type must be changed to *6* for *personal computer*. Each terminal thus created is simply a copy of the terminal type for the terminal at hand with the ISDN-MIM feature set to *None* and the display type set to *6*. For example, if the terminal to be administered is an AT&T model 7507, the system

<b>5</b>	Administration <i>Button and Feature Caveats</i>	<i>5-13</i>
----------	---	-------------

administrator might copy the 7507 terminal (type 57) to a new terminal type (that is, type 157) and modify it to exclude support of the ISDN-MIM feature.

<b>5</b>	Administration <i>Button and Feature Caveats</i>	5-14
----------	---	------



## Voice Terminal Features

# 6

---

The voice terminals connected to the DEFINITY Communications System Generic 1, Generic 2, and Generic 3, the DEFINITY Enterprise Communications Server (ECS), System 75, and System 85 provide a wide range of features. The following tables provide information on the major features of a particular type of telephone or voice terminal.

- **Tables 6-1, 6-2, 6-3, 6-4, and 6-5** show the features that are available with single-line telephones and voice terminals, and the 6402 and 6402D telephones, and the 7401D and 7401 Plus Voice Terminals.
- **Table 6-6** shows the features that are available with multiple-appearance hybrid voice terminals.
- **Tables 6-7, 6-8, 6-9, 6-10, and 6-11** show the features that are available with multiple-appearance digital voice terminals.
- **Table 6-12** shows the features available with the ISDN voice terminals.

**Table 6-1. Single-Line and 7401 Voice Terminal Features  
(500 Telephone and 2500 Series Telephones)**

Physical Features	Telephones					
	500	2500/ 2554	2500 DMGC	2500 YMGK	2500 MMGL and 2500/2554 MMGM and MMGN	2500 YMGL and 2500/2554 YMGM and YMGP
Analog	X	X	X	X	X	X
Digital						
Touch-Tone Dial		X	X	X	X	X
Rotary Dial	X					
Message Light			X	X		X
Dial Access to Features	X	X	X	X	X	X
Built-in Digital Display						
Recall Button			X	X		
Mute Button						X
Flash Button						X
Redial Button						X
Hold Button						X
Personalized Ringing						
Tone Ringing			X	X	X	X
Optional Enhancements:						
Message Waiting Adjunct		X				
Headset Adapter						
External Speakerphone						

**Table 6-2. Single-Line Telephones and 7401 Voice Terminal Features  
 (6200 Series Telephones)**

Physical Features	Telephones		
	6210	6218	6220
Analog	X	X	X
Digital			
Touch-Tone Dial	X	X	X
Message Light	X	X	X
Dial Access to Features	X	X	X
Built-in Digital Display			X
Hold Button	X	X	X
Flash Button	X	X	X
Redial Button	X	X	X
Personalized Ringing	X	X	
User Programming Button		X	X
Programmable Dialing Buttons		10	10
Lower Button			
Pause Button			X
(Set) Clock Button			
Timer Button			
Built-in Speakerphone			X
Mute Button			X
Tone Ringing	X	X	X
Ringer Volume Control	X	X	X
Data Jack	X	X	X
Power Jack			
Adjunct Equipment Jack			

**Table 6-3. Single-Line Telephones and 7401 Voice Terminal Features  
 (8100 Series Telephones)**

Physical Features	Telephones		
	8101/8101M	8102/8102M	8110/8110M
Analog	X	X	X
Digital			
Touch-Tone Dial	X	X	X
Message Light	X	X	X
Dial Access to Features	X	X	X
Built-in Digital Display			
Hold Button	X	X	X
Flash Button	X	X	X
Redial Button	X	X	X
One-Way Listen-Only Speaker			
Personalized Ringing	X	X	X
User Programming Button		X	X
Pause Button		X	X
Auto Answer Button			X
Built-in Speakerphone			X
Tone Ringing	X	X	X
Adjunct Equipment Jack		X	
Optional Equipment Headset Adapter		X	

**Table 6-4. Single-Line and 7401 Voice Terminal Features  
 (7101A through the 7104A Voice Terminals)**

Physical Features	Voice Terminals					
	7101A	7102A	7102 Plus	7103A Fixed	7103A Prog.	7104A
Analog	X	X	X	X	X	X
Digital						
Touch-Tone Dial	X	X	X	X	X	X
Message Light	X	X	X	X	X	
Dial Access to Features	X	X	X	X	X	X
Built-in Digital Display					X	
Feature-only Buttons				8	10	16
Recall Button	X	X	X	X	X	X
One-Way Listen-Only Speaker					X	
Disconnect Button	X			X	X	
Personalized Ringing				X	X	X
Last Number Dialed (or Redial) Button					X	
User Programming Button					X	X
Built-in Speakerphone						
Tone Ringing	X	X	X	X	X	X
Optional Enhancements:						
Headset Adapter			X	X	X	
External Speakerphone			X	X	X	

**Table 6-5. Single-Line Telephone and 7401 Voice Terminal Features  
 (6402 Telephones and the 7401 Voice Terminals)**

Physical Features	Telephones/Voice Terminals			
	6402	6402D	7401D (See Note 1)	7401 Plus (See Note 1)
Analog				
Digital	X	X	X	X
Touch-Tone Dial	X	X	X	X
Message Light	X	X	X	X
Dial Access to Features	X	X	X	X
Built-in Digital Display		X		
Hold, Conference, Transfer, and Redial Button	X	X		
Feature (Directory) Button	X	X	X	X
Shiftable Dial Pad Features	12	12	12	12
One-Way Listen-Only Speaker	X	X		
Message Light	X	X	X	X
Volume Control Button	X	X		
Personalized Ringing	X	X	X	X
Adjunct Equipment Jack				X
Optional Equipment				
Headset Adapter	X	X		X
External Speakerphone				X

**Note 1:**  
 This model has two "virtual" appearances, but no call appearance buttons.

**Table 6-6. Multi-Appearance Hybrid Voice Terminal Features  
(The 7200 Series and the 7300 Series Voice Terminals)**

Physical Features	Voice Terminals			
	7203H	7205H	7303S	7305S
Call Appearance Feature Buttons with In-Use and Status Lights	10	10	10	10
Feature-only Buttons		24		24
Dial and Buttons Access to Features	X	X	X	X
Conference, Transfer, Hold, and Drop Buttons	X	X	X	X
Disconnect Button	X	X		
Recall Button	X	X	X	X
Self-Test Switch			X	X
Message Light	X	X	X	X
One-Way Listen Only Speaker			X	X
Built-in Digital Display				
Built-in Speakerphone				
Personalized Ringing				
AC Powered				
DC Powered	X	X	X	X
Optional Enhancements: Headset Adapter	X	X	X	X
External Speakerphone	X	X	X	X
Call Coverage Module		X		
Function Key Module		X		

**Table 6-7. Multi-Appearance Digital Voice Terminal Features  
 (The 6400 Series Voice Terminals)**

Physical Features	Voice Terminals			
	6408 and 6408+	6408D and 6408D+	6416D+ and 6416D+M	6424D+ and 6424D+M
Call Appearance/ Feature Buttons				
Dial and Button Access to Features	X	X	X	X
Conference, Transfer, Hold, and Redial Buttons	X	X	X	X
Self-Test Capability	X	X	X	X
Message Light	X	X	X	X
Built-in Speakerphone	X (See Note 2)	X (See Note 2)	X	X
One-Way Listen-Only Speaker	X (See Note 2)	X (See Note 2)		
Mute Button	X	X	X	X
Personalized Ringing	X	X	X	X
Built-In Digital Display		X	X	X
Headset Jack			X (See Note 3)	X (See Note 3)
AC Powered				
DC Powered (supplied by PBX)	X	X	X	X
Optional Enhancements:				
Headset Adapter	X	X	X	X
XM24 Expansion Module			X	X
100A Tip/Ring Interface Module			X (See Note 3)	X (See Note 3)

**Note 2:**  
 The 6408+ and 6408D+ voice terminals have a two-way speakerphone. The 6408 and 6408D have a one-way listen-only speaker.

**Note 3:**  
 Only the Modular 6416D+M and 6424D+M have a Headset jack and a Modular interface in the desktop stand which will accommodate the Tip/Ring Module.



**Table 6-8. Multi-Appearance Digital Voice Terminal Features  
 (The 7402 Plus through the 7406 Plus Voice Terminals)**

Physical Features	Voice Terminals						
	7402 Plus	7403D	7404D	7405D	7406D	7406BIS	7406 Plus
Call Appearance/ Feature Buttons	6	10	6	10	5	5	5
Feature-Only Buttons				24	X	1	
Shiftable Feature Buttons					8	8	9
Dial and Buttons Access to Features	X	X	X	X	X	X	X
Conference, Transfer, Hold, and Drop Buttons	X	X	X	X	X	X	X
Disconnect Button		X		X			
Self-Test Capability	X	X	X	X		X	X
Message Light	X	X	X	X	X	X	X
Built-in Speakerphone	X (See Note 4)				X (See Note 4)	X	X
Reset Speakerphone Capability							X
Mute Button						X	X
Built-in Digital Display					X (See Note 5)	X (See Note 5)	X (See Note 5)
Personalized Ringing	X				X	X	X
Built-in Data Module and Data Call in Progress Light			X				

*Continued on Next Page*

**Table 6-8. Multi-Appearance Digital Voice Terminal Features**  
 (The 7402 Plus through the 7406 Plus Voice Terminals) — *Continued*

Physical Features	Voice Terminals						
	7402 Plus	7403D	7404D	7405D	7406D	7406BIS	7406 Plus
AC Powered			X				
DC Powered (supplied by PBX)	X	X		X	X	X	X
Optional Enhancements:	X	X		X	X	X	X
Headset Adapter							
External Speakerphone	X	X		X	X	X	X
Digital Terminal Data Module		X		X			
Data Module Base					X		
Call Coverage Module				X			
Function Key Module				X			
Digital Display Module				X			
Messaging Cartridge			X				
7400B+ Data Module	X	X	X	X	X	X	X

**Note 4:**  
 The 7402 Plus and 7406D01A — 7406D04A voice terminals have a one-way listen-only speaker.

**Note 5:**  
 The following 7406 sets have built-in displays: 7406D01A, 7406D03A, 7406D05A, and 7406D07A.

**Table 6-9. Multi-Appearance Digital Voice Terminal Features  
 (The 7407 through the 7444 Voice Terminals)**

Physical Features	Voice Terminals						
	7407D	Enhanced 7407D	7407 Plus	7410	7410 Plus	7434	7444
Call Appearance/ Feature Buttons	10	10	10	10	10	34	34
Feature-only Buttons	11	24	24				
Dual-Function Feature Buttons	11						
Display Control Buttons	7	7	7				
Dial and Button Access to Features	X	X	X	X	X	X	X
Conference, Transfer, Hold, and Drop Buttons	X	X	X	X	X	X	X
Self-Test Capability	X	X	X	X	X	X	X
Message Light	X	X	X	X	X	X	X
Built-in Speakerphone	X	X	X		X (See Note 6)		X
Reset Speakerphone Capability			X				X
Mute Button		X	X				X
Built-in Digital Display	X	X	X				X
Personalized Ringing	X	X	X	X	X	X	X

*Continued on Next Page*

**Table 6-9. Multi-Appearance Digital Voice Terminal Features**  
 (The 7407 through the 7444 Voice Terminals) — *Continued*

Physical Features	Voice Terminals						
	7407D	Enhanced 7407D	7407 Plus	7410	7410 Plus	7434	7444
AC Powered	X						
DC Powered (supplied by PBX)		X	X	X	X	X	X
Optional Enhancements: Headset Adapter		X	X	X	X	X	X
External Speakerphone		X	X	X	X	X	X
Data Module Base	X						
Call Coverage Module						X	
Digital Display Module						X	
7400B+ Data Module	X	X	X	X	X	X	X

**Note 6:**  
 The 7410D02A voice terminal has a one-way listen-only speaker.

**Table 6-10. Multi-Appearance Digital Voice Terminal Features  
 (The 8400 Series Voice Terminals)**

Physical Features	Voice Terminals				
	8403	8405	8410	8411	8434 and 8434DX
Call Appearance/ Feature Buttons	3	5	10	10	34
Dial and Button Access to Features	<b>X</b>	<b>X</b>	<b>X</b>	<b>X</b>	<b>X</b>
Conference, Transfer, Hold, and Drop Buttons	<b>X</b>	<b>X</b>	<b>X</b>	<b>X</b>	<b>X</b>
Built-in Digital Display		<b>X</b> (See Note 7)	<b>X</b> (See Note 7)	<b>X</b> (See Note 7)	<b>X</b> (See Note 7)
Softkeys		<b>X</b> (See Note 7)	<b>X</b> (See Note 7)	<b>X</b> (See Note 7)	<b>X</b> (See Note 7)
Self-Test Capability	<b>X</b>	<b>X</b>	<b>X</b>	<b>X</b>	<b>X</b>
Message Light	<b>X</b>	<b>X</b>	<b>X</b>	<b>X</b>	<b>X</b>
One-Way Speaker	<b>X</b> (See Note 8)	<b>X</b> (See Note 8)			
Built-in Speakerphone		<b>X</b> (See Note 9)	<b>X</b> (See Note 9)	<b>X</b> (See Note 9)	<b>X</b> (See Note 9)
Softkeys		<b>X</b> (See Note 9)	<b>X</b> (See Note 9)	<b>X</b> (See Note 9)	<b>X</b> (See Note 9)
Mute Button	<b>X</b>	<b>X</b>	<b>X</b>	<b>X</b>	<b>X</b>
Personalized Ringing	<b>X</b>	<b>X</b>	<b>X</b>	<b>X</b>	<b>X</b>

*Continued on Next Page*

**Table 6-10. Multi-Appearance Digital Voice Terminal Features  
 (The 8400 Series Voice Terminals) — Continued**

Physical Features	Voice Terminals				
	8403	8405	8410	8411	8434 and 8434DX
Analog Adjunct Jack				X	
EIA-232-D Jack for PassageWay Connection				X	
AC Powered					
DC Powered (supplied by PBX)	X	X	X	X (See Note 10)	X (See Note 10)
Optional Enhancements:					
Headset Adapter	X	X	X	X	X
External Speakerphone	X	X	X	X	X
801A Expansion Module					X (See Note 11)
7400B+ Data Module	X	X	X	X	X

**Note 7:**  
 The 8405D, 8405D Plus, 8410D, 8411D, 8434, and 8434DX voice terminals have a display and softkeys.

**Note 8:**  
 The 8403, 8405B, and 8405D voice terminals have a one-way listen-only speaker.

**Note 9:**  
 Only the 8405B Plus, 8405D Plus, 8410, 8411, 8434, and 8434DX voice terminals have a built-in speakerphone and thus access to the Reset Speakerphone feature. The 2-way speakerphone can also be optioned as a one-way speakerphone or turned off.

**Note 10:**  
 The 8411, 8434, and 8434DX voice terminals require an auxiliary power supply. An MSP-1 Power Supply is recommended.

**Note 11:**  
 Only the 8434DX has an "EX MOD" jack on the bottom of the set which allows connection of an 801A Expansion Module.

**Table 6-11. Multi-Appearance Digital Voice Terminal Features  
 (The CALLMASTER Voice Terminals)**

Physical Features	Voice Terminals				
	602 CM	CM II and III	CM IV	CM V	CM VI (see Note 12)
Call Appearance/Feature Buttons	10	6	6		2
Feature-only Buttons	17	15	15		3
Dial and Buttons Access to Features	X	X	X	X	X
Conference, Transfer, Hold, and Drop Buttons	X	X	X	X	
Select Button		X	X		
Self-Test Capability		X	X		
Message Light	X	X	X	X	X
Mute Button	X	X	X	X	
Release Button	X	X	X		X
Log In Button		X	X		
Headset On/Off Button					X
Built-in Digital Display	X	X	X	X	(See Note 12)
Personalized Ringing	X	X	X	X	X
AC Powered					
DC Powered (supplied by PBX)	X	X	X	X	X
Optional Enhancements:					
Headset Adapter	X	X	X		X
External Speakerphone	X	X	X		
7400B+ Data Module	X	X	X		

**Note 12:**

The CALLMASTER VI works with a PC software application such as CentruVu® Agent software, and the agent uses the buttons shown on the PC monitor screen rather than the buttons on the voice terminal.

**Table 6-12. Multi-Appearance ISDN Voice Terminal Features  
 (The 7500 Series and 8500 Series Voice Terminals)**

Physical Features	Voice Terminals					
	7505	7506	7507	8503T	8510T	8520T
Call Appearance/Feature Buttons with Lights	9 or 10 (See Note 13)	9 or 10 (See Note 13)	30 or 31 (See Note 13)	3	10	20
Shiftable Feature Buttons	4	4				
Feature-Only Buttons			9			
Dial and Buttons Access to Features	X	X	X	X	X	X
Conference, Transfer, Hold, and Drop Buttons	X	X	X	X	X	X
Memory Dialing				X		
Message Light	X	X	X	X	X	X
Redial Button	X	X	X	X	X	X
Self-Test Capability	X	X	X	X	X	X
Built-in Speakerphone	X	X	X		X	X
Mute Button	X	X	X	X	X	X
Built-in Digital Display		X	X		X	X
Softkeys and Display Control Buttons					X	X
Personalized Ringing	X	X	X	X	X	X
Optional Enhancements: Headset Adapter	X	X	X	X	X	X
Asynchronous Data Module	X	X	X		X	X

**Note 13:**

If the 7505 or 7506 sets have data, there are only 9 (or 30) call appearance/feature buttons.  
 If the 7507 terminal has data, there are 30 (rather than 31) call appearance/feature buttons.



## The 6400 Series Telephones



---

The following 6400 Series Telephones are described in this section:

- 6402 and 6402D telephones
- 6408+ and 6408D+ telephones
- 6416D+ and 6416D+M telephone
- 6424D+ and 6424D+M telephone

## The 6402 and 6402D Telephones

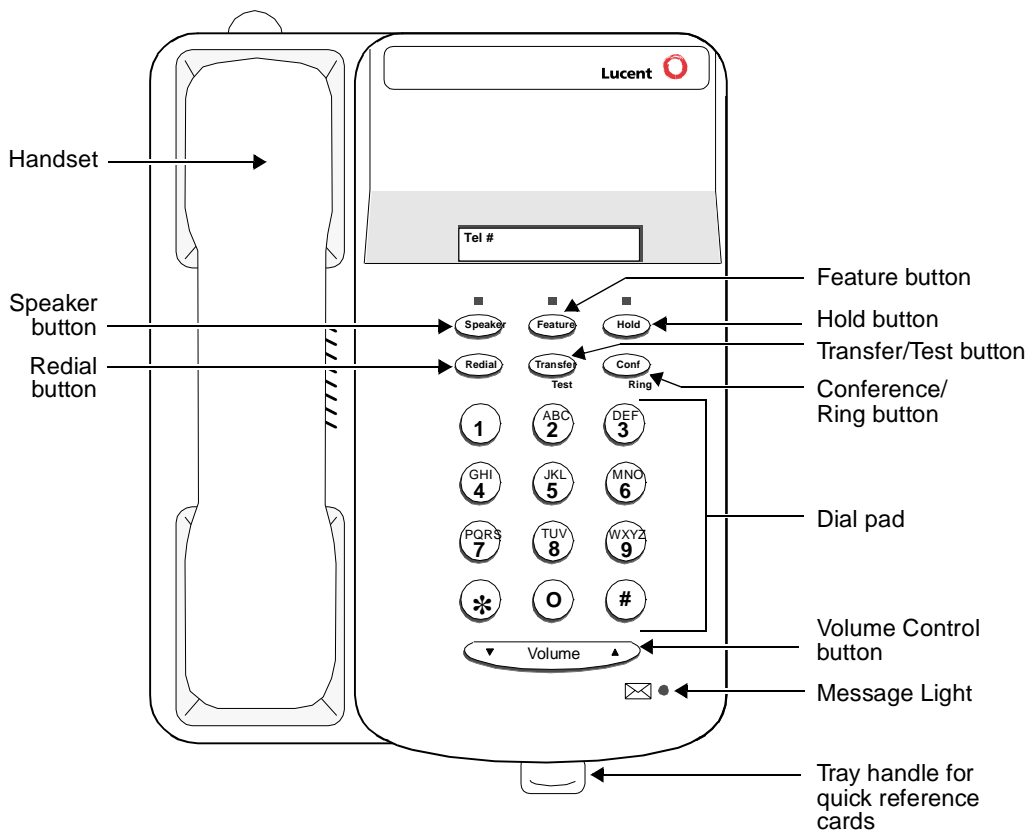

Figure 7-1. The 6402 Telephone

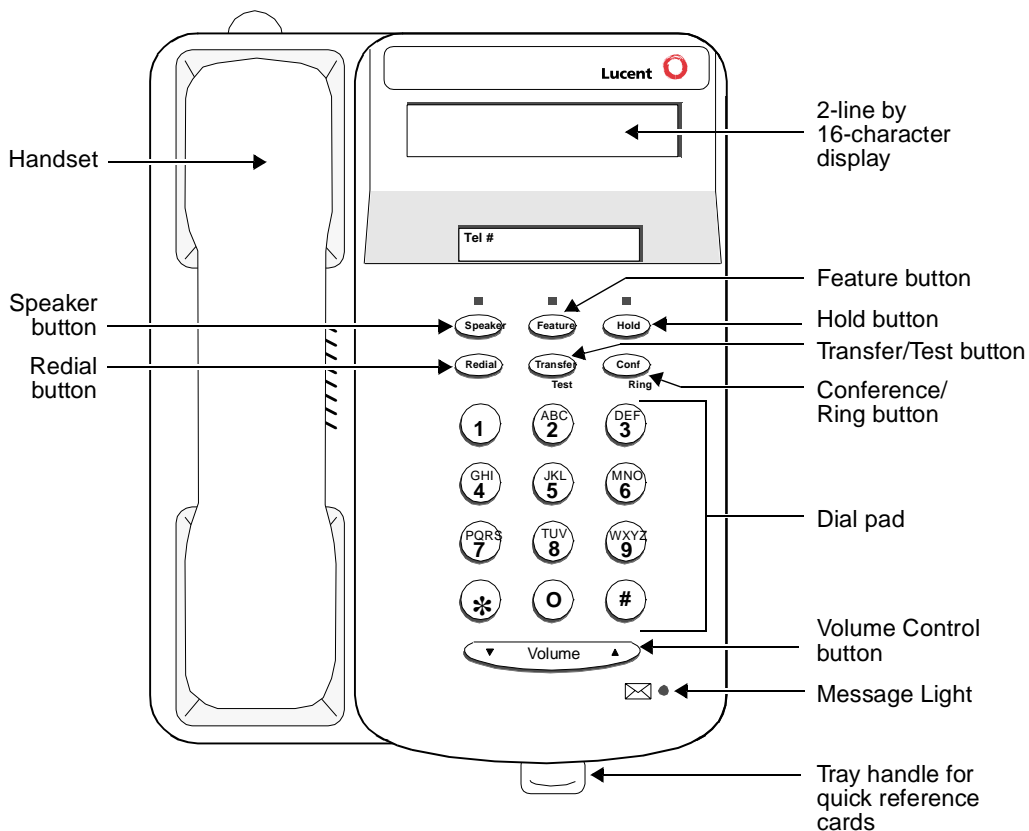

Figure 7-2. The 6402D Telephone

The 6402 and 6402D are single-line telephones with six fixed feature buttons: a listen-only Speaker button, a Feature button that allows you to use the dial pad keys for up to 12 features assigned by the system manager, a red Hold button, a Redial button, a Transfer button that can also be used for the Test feature, and a Conference button that can also be used to select a personalized ringing pattern, a red Message light, and a Volume control button. The 6402D also has a 2-line by 16-character LCD display.

**NOTE:**

The 6402 and 6402D can be used ONLY in a 2-wire environment. For more information, see the section on "Wiring Information."

## Applications

---

The 6402 telephones can best be used with the DEFINITY Enterprise Communications Server (ECS) Release 6.1 and later. This telephone is especially suitable for general office workers with low call volumes, manufacturing, warehousing, guard and/or reception areas, or office desks.

## Physical Features

---

### Dimensions



**NOTE:**

The dimensions described here for the 6402 and 6402D telephones are approximate.

Width = 7 inches (17.78 cm)

Depth (front to back) = 8.5 inches (21.59 cm)

Height (with deskstand and handset in place) = 4.75 inches (12.07 cm)

### Features

#### Six Fixed Feature Buttons

The 6402 and 6402D telephones have the following six fixed feature buttons:

- SPEAKER button
- FEATURE button
- HOLD button
- REDIAL button
- TRANSFER/TEST button
- CONFERENCE/RING button (labeled CONF)

#### SPEAKER Button

The 6402 and 6402D telephones are set for the 1-way, listen-only Speaker feature. The user can only listen to the far-end. However, in order to speak with the other party, the user must use the handset.

#### The Feature Button

The FEATURE button allows the dial pad to serve as 12 feature buttons without indicators. These features are accessed by pressing the FEATURE button and then one of the 12 dial pad keys.

The user has access to a Feature card among the cards in the tray located under the base of the telephone on which the system manager or the user can write the features administered on each of the dial pad keys.

### **HOLD Button**

The red HOLD button can be used to put a call on hold. When a call is on hold, the red light associated with the HOLD button flashes.

### **REDIAL Button**

The REDIAL button is used to redial the last number the user dialed from the dial pad.

### **TRANSFER/TEST button**

The TRANSFER button can be used in a couple ways: When the telephone is off-hook, the user can press the TRANSFER button to transfer a call. When the phone is on-hook, the user can test the lights on the telephone, and if the user has a 6402D telephone, he or she can use the TRANSFER button to test the display. (In the latter case, all the display segments fill in.)

### **CONF/RING Button**

The CONFERENCE/RING button can be used in a couple ways: When the telephone is off-hook, the user can use this button to set up a conference call with five other people. When the phone is on-hook, the user can press this button to select a personalized ringing pattern from among eight different patterns.

### **VOLUME Control button**

The 6402 and 6402D telephones have a VOLUME "arrow" button on the front of the set. This button has several functions. When the user is using the 1-way speaker, the VOLUME button controls the volume of the speaker. When the user is on a call using the handset, the VOLUME button controls the volume of the handset. When the telephone is idle, the button controls the volume of the tone ringer.

### **Message Light**

The red Message light goes on when a message is left for the user. It goes off when the user retrieves the message or when the message is erased.

## **Other Physical Features**

### **Pull-out tray**

Five quick reference cards are provided in the tray located under the base of every 6400 Series telephone.

### **Handset**

The 6402 and 6402D telephones are equipped with an AJ2A handset.

### **Dial pad**

These telephones are equipped with a 12-button touch-tone dial pad. The letters "Q" and "Z" have been added to the appropriate dial pad keys for directory access, and the "5" button on the dial pad has raised bars for visually-impaired users.

### **Jacks**

The 6402 and 6402D telephones' housing has a Line jack and a Handset cord jack located on the back of the housing.

### **Cords**

Two cords are supplied with the 6402 and 6402D: a coiled 9-foot handset cord and a 7-foot line cord.

Optional longer cords are available: a 12-foot handset cord and 14-foot and 25-foot line cords.

### **Ringling**

These telephones have electronic tone ringing. With the Select Ring feature, the user can choose any one of eight different ringing patterns. The set has a Volume control button which controls the loudness of the ringer, the speaker, and the handset.

### **Mounting Options**

The 6402 and 6402D telephones come equipped with a nonadjustable desk stand. The user can reverse the stand and then mount the telephone on the wall.

### **Color Options**

The 6402 and 6402D telephones are available in gray and in white.

## Wiring Information

---

The 6402 and 6402D telephones work in ONLY a 2-wire DCP configuration. The table below describes the pins on a 6400-Series telephone LINE jack.

**Table 7-1. The Pins on a 6400-Series telephone LINE Jack**

---

Line Interface			
Pin	Pair	Name	Description
4	1	U-T	2-Wire (Tip)
5	1	U-R	2-Wire (Ring)
7	4	P1-	Adjunct Power -48V
8	4	P2+	Adjunct Power Common

---

### Notes on 6400 Series 2-Wire Installation and Wiring:

ALL wiring between the PBX and the telephone wall jack MUST consist of twisted-pairs. The line cord must be either a D8W, which consists of 4 twisted-pairs, or a D2R which is a 2-conductor non-twisted pair cord. Only these cord types have been approved by Lucent Technologies. For optimum performance, the line cord length should not extend beyond that originally supplied with the telephone.

A D8W modular cord MUST be used for all 2-wire installations requiring auxiliary power. If using an auxiliary power supply such as a Lucent Technologies 1151A, it is acceptable to have a D2R cord connected from the wall jack to the LINE jack found on the power supply.

For 2-wire operation, if you need to plug the telephone into a 4-pin or 6-pin wall jack, instead of a standard 8-pin modular jack, refer to the "Line Interface" table above to insure that the wires from the 4-pin or 6-pin wall jack are connected to the correct pins on the telephone "LINE" jack.

The 6400 Series telephones can be connected to either a RJ45x or an RJ11C station jack. If connected to an RJ11C, a 2-wire/4-wire Line Adapter must be installed. This adapter is available to accommodate situations where customers need to upgrade from an analog type RJ11C jack to an 8-wire RJ45x type jack. This adapter only works when using a 6400 Series telephone on either the 2-wire 16-port (TN2181) or the 24-port (TN2224) digital line circuit card.

In 2-wire installations using an RJ45x station jack, PBX connections must be on pins 4 and 5 and auxiliary power must be connected to pins 7 and 8. In 2-wire installations using an RJ11C station jack, PBX connections must be on pins 3 and 4 and auxiliary power must be connected on pins 2 and 5.

REMOVE ALL CONNECTIONS BETWEEN PAIRS BEFORE CONNECTING THE TELEPHONE.

## Appropriate Circuit Packs and Distance Limitations

---

The 6400 Series telephones can only be connected in a 2-wire mode behind the TN2181 and the TN2224 digital circuit packs.

In 2-wire operation, the telephone must be within 5,500 feet of the PBX using 22-gauge wire, within 3,500 feet of the PBX using 24-gauge wire, and within 2,200 feet of the PBX using 26-gauge wire.

## Power Requirements

---

The 6402 and 6402D telephones receive power from the system and do not require an external power supply.

## Administration

---

The 6402 telephone can be administered as itself on a DEFINITY system starting with Release 6.1 software. The 6402D telephone can be administered as itself on DEFINITY Release 6.3 (or later) system. The 6402 telephone will NOT work with any DEFINITY switch release prior to the DEFINITY Release 6.1; the 6402D will NOT work with any DEFINITY switch release prior to the DEFINITY Release 6.3.



### NOTE:

When administering the 6402 and 6402D telephones on a DEFINITY switch, you must select "One-way" or "None" as the speaker option on the Administration Form.

## Button Numbering

The following button diagrams of the 6402 and 6402D telephones will help you administer the telephones connected to a DEFINITY system.

If you need more information, refer to *DEFINITY Communications System Generic 3 Implementation*, 555-230-653.



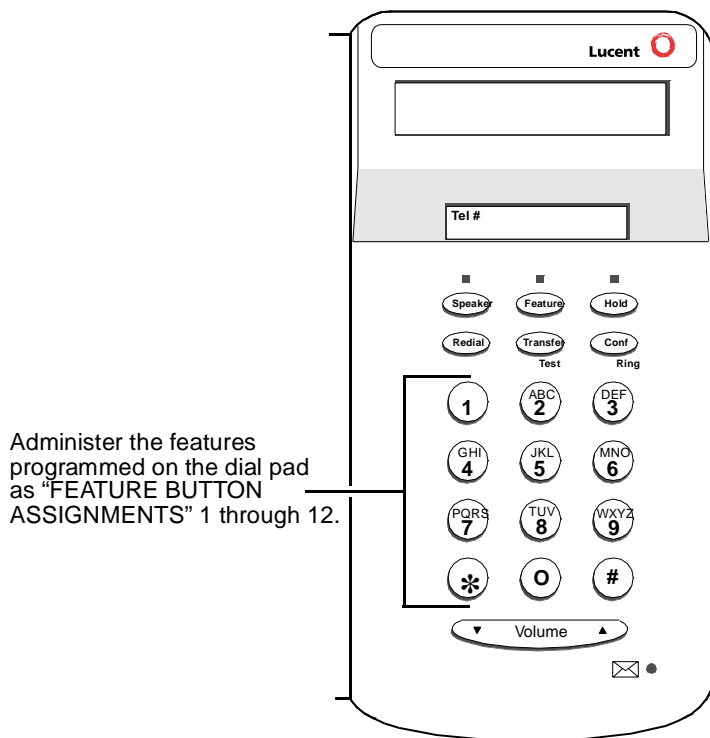

Figure 7-3. Button Numbering for Administering the 6402 and 6402D Telephone Connected to a DEFINITY System Release 6.1 or Later

### Power Failure Operation

The 6400 Series telephones cannot be used as an emergency station during power failure transfer conditions.

### FCC Registration

The 6400 Series telephones are FCC-registered along with the switch (as a system), but do not have a separate FCC registration label.

### UL and CSA Approval

The 6400 Series telephones have been tested and have met the Underwriters Laboratories (UL) Standards UL 1459 and have also met the Canadian Standards Association (CSA) Standards CSA-C22.2 No.225-M90.

## Hearing Aid Compatible

The 6400 Series telephones are compatible with the inductively coupled hearing aids approved by the FCC.

## 6402 and 6402D Equipment PECs and Comcodes

The 6402 and 6402D telephones and components can be ordered with these PECs and Comcodes:

- **Basic 6402 (6402D02A) telephone**  
Gray 6402 Set PEC: 3301-02G  
Comcode: 108018284;  
White 6402 Set PEC: 3301-02W  
Comcode: 108018185
- **Basic 6402D (6402D01A) telephone**  
Gray 6402D Set PEC: 3302-02G  
Comcode: 108017989;  
White 6402 Set PEC: 3302-02W  
Comcode:108017880
- **AJ2A Handset**  
Comcode: Gray=220035018; White=220035000
- **Handset cord (9 feet)**  
Comcode: Gray and White cord comcodes not available at this time
- **Line cord (7 feet)**  
PEC: 2725-07G  
Comcode: 103786778
- **Line cord (14 feet, silver)**  
PEC: 2725-07N (COL18)  
Comcode: 103786828
- **Line cord (25 feet, silver)**  
PEC: 2725-07S (COL18)  
Comcode: 103786802
- **Designation Card Cover**  
PEC: 32306  
Comcode: 846506780
- **Button Designation Cards**  
Laser Sheet For 25 Sets, 5 Sheets  
PEC: 32307  
Comcode: 847991718;  
Laser Sheet, For 100 Sets, 20 Sheets  
PEC: 32308  
Comcode: 847167970

7 The 6400 Series Telephones  
    *The 6402 and 6402D Telephones*

7-11

## Adjuncts

---

The 6400 Series telephones do NOT have an Adjunct jack and therefore will not support any adjunct equipment.



**NOTE:**

The Headsets mentioned below are plugged into the Handset jack.

## Headsets

A list of compatible headsets, consisting of both modular and plug prong base units and selection of headpieces, appears in "Headset Adapters" in the **Adjuncts** section later in this manual.

## Additional Documents

---

The following documents contain additional information relating to the 6402 and 6402D telephones: (Use the 9 digit number listed after each document to order that book from the BCS Publications Center for Lucent Technologies.)

- *6400 Series Single-line Telephones User's Guide*, 555-230-738
- *6400 Series Single-line Telephones Quick Reference Cards*, 555-230-751

# The 6408+ and 6408D+ Telephones

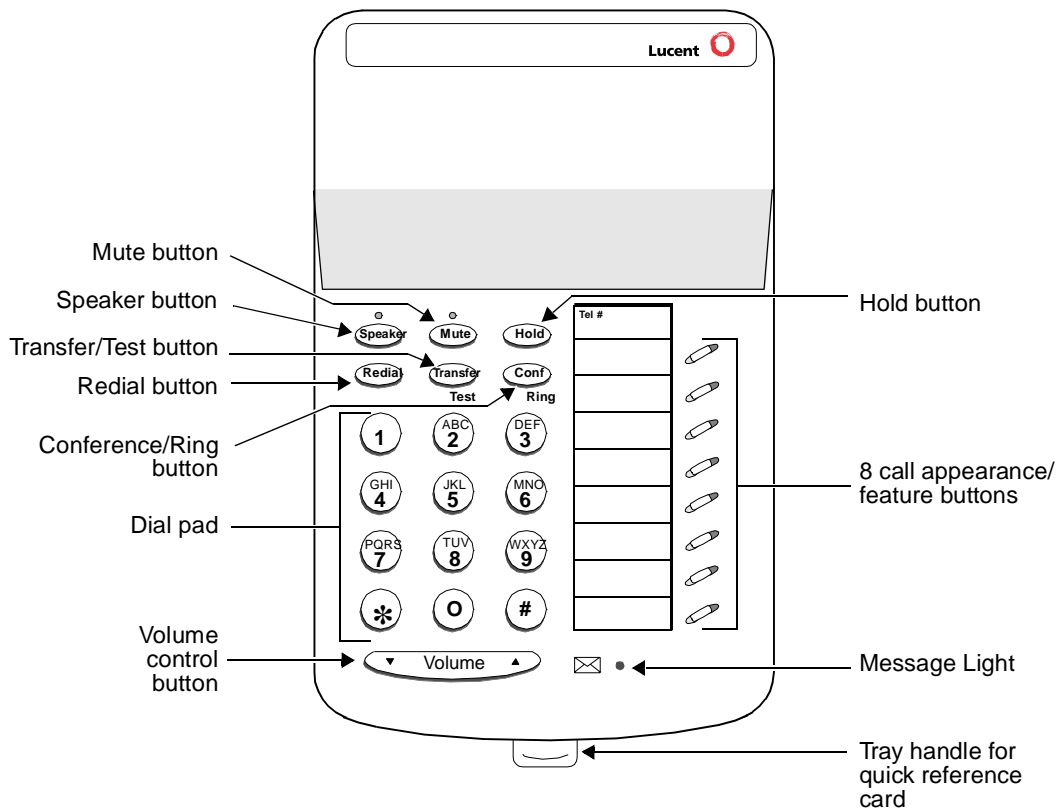

Figure 7-4. The 6408+ Telephones

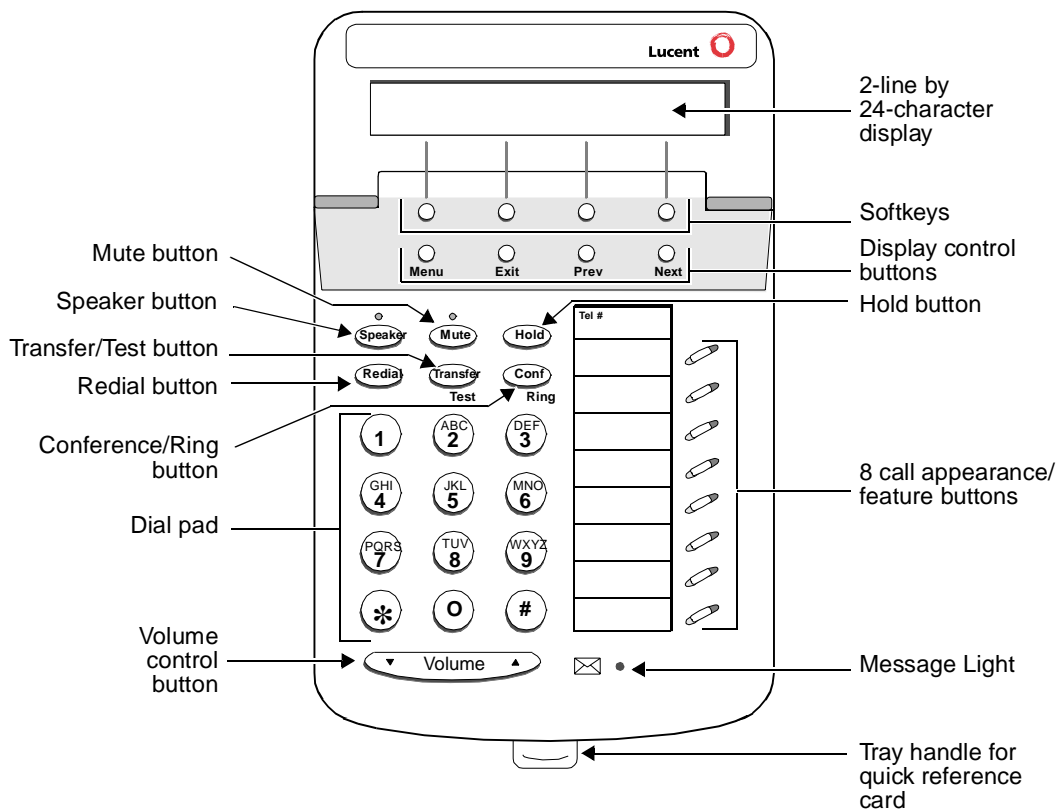

Figure 7-5. The 6408D+ Telephone (With Display)

There are two 6408 telephone models: the 6408+ and the 6408D+. Both of these models are multi-appearance digital telephones with eight call appearance/feature buttons. The 6408 telephones also have six standard fixed feature buttons: SPEAKER button, which can access a 2-way speakerphone, MUTE button to mute the handset or speakerphone microphone, a red HOLD button, REDIAL button, TRANSFER/TEST button for transferring a call or testing the lights and display on the telephone, and a CONF/RING button for setting up a conference call and for selecting a personalized ringing pattern. These telephones also have a red Message light and a Volume control button.

However, these 6408 models have the following differences:

- The 6408+ has a 2-way speakerphone, without a display.
- The 6408D+ has a 2-way speakerphone and a 2-line by 24-character display.

7 The 6400 Series Telephones  
The 6408+ and 6408D+ Telephones

7-14

Those users who have a 6408D+ (the 6408 telephone with display) can access 12 features with the softkeys and display control buttons. These 12 features can be used *in addition to* the features on the call appearance/feature buttons.

 NOTE:

The 6408 telephones can work **ONLY** in a 2-wire environment. For more information, see "Wiring Information."

## Applications

---

Both 6408 telephones have been developed to be used with the DEFINITY ECS Release 6.1 and later. This type of telephone is especially suitable for managers, executive secretaries, and other office support personnel who require access to multiple lines for call handling, call coverage, bridging, conferencing, and sophisticated voice communications. The 6408D+ display set can be used by those who have a need for calling party display capabilities or who require a large number of telephone features.

## Physical Features

---

### Dimensions

 NOTE:

The dimensions described here for the 6408 telephones are approximate.

Width = 7.8 inches (20 cm)

Depth (front to back) = 8.5 inches (21.59 cm)

Height (with deskstand and handset in place) = 4.75 inches (12.07 cm)

### Features

#### Six Fixed Feature Buttons

The 6408 telephones have the following six fixed feature buttons:

- SPEAKER button
- MUTE button
- HOLD button
- REDIAL button
- TRANSFER/TEST button
- CONFERENCE (labeled CONF)/RING button

## Speakerphone

The 6408+ and the 6408D+ telephones are equipped with a built-in 2-way speakerphone. (The telephone can be optioned for a 1-way, listen-only speaker instead. The system manager should have records of how this feature is optioned.) The Speakerphone capability allows a user to engage in a hands-free conversation with the far-end party. The speakerphone can be turned on or off with the SPEAKER button; can be muted with the MUTE button, and the volume can be raised and lowered with the VOLUME "arrow" button.

## Speaker (Listen-Only) Feature

The 6408+ and the 6408D+ have a two-way speakerphone; however, these two telephones can be optioned instead for a 1-way, listen-only speaker. If this is the case, use the SPEAKER button on the front of the telephone for turning on and off the speaker.

The Speaker (listen-only) capability allows a user to engage in a 1-way conversation with the far-end. Specifically, the user can only listen to the far-end. To speak with the far-end, the user must use the handset which turns off the speaker. The Speaker function may also be disabled.

## MUTE Button

The MUTE button is a fixed feature button with a red status light. The MUTE button turns off the microphone of the built-in speakerphone or the handset so that a person can converse with another person in the room without the other party listening in.

## HOLD Button

The red HOLD button can be used for putting a call on hold. When a call is on hold, the green light next to the held call flashes.

## REDIAL Button

The REDIAL button can be used for redialing the last number you dialed from the dial pad.

## TRANSFER/TEST button

The TRANSFER/TEST button can be used in a couple ways: When the telephone is off-hook, the user can press the TRANSFER button to transfer a call. When the phone is on-hook, the user can use the TRANSFER button to test the lights and the display. (In the latter case, all the display segments fill in.)

## CONFERENCE/RING Button

The CONFERENCE/RING button can be used in a couple ways: When the telephone is off-hook, the user can use this button to set up a conference call with five other people. When the phone is on-hook, the user can press this button to select a personalized ringing pattern from among eight different patterns.

## Call Appearance/Feature Buttons

Both 6408 telephones have eight call appearance/feature buttons, each equipped with a red and a green light. Usually, at least two of these buttons are administered as call appearances for the telephone's primary extension number, where calls are placed and answered. The remainder of the buttons can be used for more call appearances (including bridged appearances of other stations' extensions) and features. Buttons administered for features have only their green status lights active.

## Message Light

The red Message light goes on when a message is left for the user. It goes off when the user retrieves the message or when the message is erased.

## VOLUME Control button

The 6408 telephones have a VOLUME "arrow" button on the front of the set. This button has several functions. When the user is using the speakerphone or the 1-way speaker, the VOLUME button controls the volume of the speaker. When the user is on a call using the handset, the VOLUME button controls the handset volume. When the telephone is idle, the button controls the volume of the tone ringer.

When the user sets the volume for the speaker, speakerphone, handset, or the tone ringer, the display on the 6408D+ telephones shows a "bar array" that indicates the volume setting.

## Display

The display on the 6408D+ has two lines with 24 characters on each line. The display, along with the softkeys and the display control buttons, can be used to access 12 softkey features (the default softkey features and the alternative softkey features are listed under "Softkeys").

## Display Control Buttons

These four buttons are labeled **Menu**, **Exit**, **Prev**, and **Next**.

- The **Menu** button is used to enter Softkey Mode and access the 12 softkey features.
- The **Exit** button is used for exiting a display feature and returning to Normal (call-handling) Mode.
- The **Prev** and **Next** buttons can be used to go back and forth through the feature option screens.

## Softkeys

The four buttons located below the display and labeled with arrows correspond to features listed on the second line of the display screen. (There are four features on each feature option screen.) The user can access any of the 12 features by pressing the softkey below the feature abbreviation.



Below is a list of the 12 default softkey features assigned to the 6408D+ and the order in which they appear.

**Table 7-2. Default Softkey Features on the 6408D+**

Abbreviation	Feature
<b>First Screen Dir*</b>	System Directory
<b>Drop</b>	Drop
<b>HFAns</b>	Internal Auto Answer
<b>Timer</b>	Timer
<b>Second Screen PCall*</b>	Priority Calling
<b>AutCB</b>	Automatic Callback
<b>Prog</b>	Abbreviated Dialing Program
<b>Pause</b>	Abbreviated Dialing Pause
<b>Third Screen LWC</b>	Leave Word Calling
<b>RngOf</b>	Ringer Off
<b>BtnVu</b>	Button Assignment/View
<b>Admin</b>	Self-Administration

\* A Call Display button should be administered, if access to System Directory is provided.

On 6408D+ telephones connected to a DEFINITY system Release 6.1 or later, the system manager can choose to administer alternate features for use with the softkeys. The following table lists some of the alternate softkey features that can be substituted for the default softkey features listed on the previous page.



**NOTE:**

Future releases of the DEFINITY system may provide additional alternate softkey features.



**NOTE:**

The DEFINITY system can download *BLANK* softkey labels for positions where there are no features administered.

**Table 7-3. Alternate Softkey Features on the 6408D+ Connected to a DEFINITY ECS Release 6.1 and Later**

<b>Abbreviation</b>	<b>Feature</b>
<b>Acct</b>	Account Code Entry
<b>AD</b>	Abbreviated Dialing buttons (can be multiple AD buttons)
<b>CFrwd</b>	Call Forwarding All Calls
<b>CPark</b>	Call Park
<b>CPkUp</b>	Call Pickup
<b>CnLWC</b>	Cancel Leave Word Calling
<b>Cnslt</b>	Consult
<b>Count</b>	ACD Stroke Count
<b>Dpkup</b>	Directed Call Pickup
<b>Excl</b>	Manual Exclusion
<b>GrpPg</b>	Group Paging
<b>IAuto</b>	Intercom Auto
<b>IDial</b>	Intercom Dial
<b>Inspt</b>	Inspect
<b>Mark</b>	AD Special Function Mark
<b>Park</b>	Call Park to other Extensions
<b>SAC</b>	Send All Calls
<b>SFunc</b>	Abbreviated Dialed Special Function
<b>Spres</b>	Abbreviated Dialing Special Function Suppress
<b>Stats</b>	View (ACD) Statistics
<b>Stop</b>	Abbreviation Dialing Indefinite Wait or Stop
<b>Wait</b>	AD Special Function Wait

## **Other Physical Features**

### **Pull-out tray**

Five quick reference cards are provided in the tray located under the base of every 6400 Series telephone.

### **Handset**

Both 6408 telephones are equipped with an AJ2A handset.

### **Dial pad**

Both 6408 telephones have a 12-button touch-tone dial pad. The letters "Q" and "Z" have been added to the appropriate dial pad keys for directory access, and the "5" button on the dial pad has raised bars for visually-impaired users.

### **Jacks**

Both 6408 telephones' housing has a Line jack and a Handset cord jack located on the back of the housing.

### **Cords**

Two cords are supplied with the 6408: a coiled 9-foot handset cord and a 7-foot line cord.

Optional longer cords are available: a 12-foot handset cord and 14-foot and 25-foot line cords.

### **Ringling**

Both 6408 telephones have electronic tone ringing with eight possible ringing patterns which you can select by pressing the CONF button while on-hook. The loudness of the tone ringer can be controlled by the VOLUME "arrow" button. (The user must NOT be on a speakerphone call. If the user is using the speakerphone, the VOLUME "arrow" button controls the volume of the speakerphone.)

### **Mounting Options**

Both 6408 telephones come equipped with a nonadjustable desk stand. The user can reverse the stand and then mount the telephone on the wall.

### **Color Options**

Both 6408 telephones are available in gray and in white.

## Wiring Information

Both 6408 telephones work in a 2-wire DCP configuration ONLY. The table below describes the pins on a 6400-Series telephone LINE jack.

**Table 7-4. The Pins on a 6400-Series Telephone LINE Jack**

Line Interface			
Pin	Pair	Name	Description
4	1	U-T	2-Wire (Tip)
5	1	U-R	2-Wire (Ring)
7	4	P1-	Adjunct Power -48V
8	4	P2+	Adjunct Power Common

### Notes on 6400 Series 2-Wire Installation and Wiring:

ALL wiring between the PBX and the telephone wall jack MUST consist of twisted-pairs. The line cord must be either a D8W, which consists of 4 twisted-pairs, or a D2R which is a 2-conductor non-twisted pair cord. Only these cord types have been approved by Lucent Technologies. For optimum performance, the line cord length should not extend beyond that originally supplied with the telephone.

A D8W modular cord MUST be used for all 2-wire installations requiring auxiliary power. If using an auxiliary power supply such as a Lucent Technologies 1151A, it is acceptable to have a D2R cord connected from the wall jack to the LINE jack found on the power supply.

For 2-wire operation, if you need to plug the telephone into a 4-pin or 6-pin wall jack, instead of a standard 8-pin modular jack, refer to the "Line Interface" table above to insure that the wires from the 4-pin or 6-pin wall jack are connected to the correct pins on the telephone "LINE" jack.

The 6400 Series telephones can be connected to either a RJ45x or an RJ11C station jack. If connected to an RJ11C, a 2-wire/4-wire Line Adapter must be installed. This adapter is available to accommodate situations where customers need to upgrade from an analog type RJ11C jack to an 8-wire RJ45x type jack. This adapter only works when using a 6400 Series telephone on either the 2-wire 16-port (TN2181) or the 24-port (TN2224) digital line circuit card.

In 2-wire installations using an RJ45x station jack, PBX connections must be on pins 4 and 5 and auxiliary power must be connected to pins 7 and 8. In 2-wire installations using an RJ11C station jack, PBX connections must be on pins 3 and 4 and auxiliary power must be connected on pins 2 and 5.

**REMOVE ALL CONNECTIONS BETWEEN PAIRS BEFORE CONNECTING THE TELEPHONE.**

## **Appropriate Circuit Packs and Distance Limitations**

---

The 6400 Series telephones can only be connected in a 2-wire mode behind the TN2181 and the TN2224 digital circuit packs.

In 2-wire operation, the telephone must be within 5,500 feet of the PBX using 22-gauge wire, within 3,500 feet of the PBX using 24-gauge wire, and within 2,200 feet of the PBX using 26-gauge wire.

## **Power Requirements**

---

Both 6408 telephones receive power from the system and do not require any external power supply.

## **Administration**

---

Both 6408 telephones can be administered as themselves on a DEFINITY system starting with Release 6.1 software. These telephones will NOT work with any DEFINITY switch release prior to Release 6.1.

## **Button Numbering**

The following button diagrams of the 6408 telephones will help you administer the telephones connected to a DEFINITY system Release 6.1 or later.

If you need more information, refer to *DEFINITY Communications System Generic 3 Implementation*, 555-230-653.

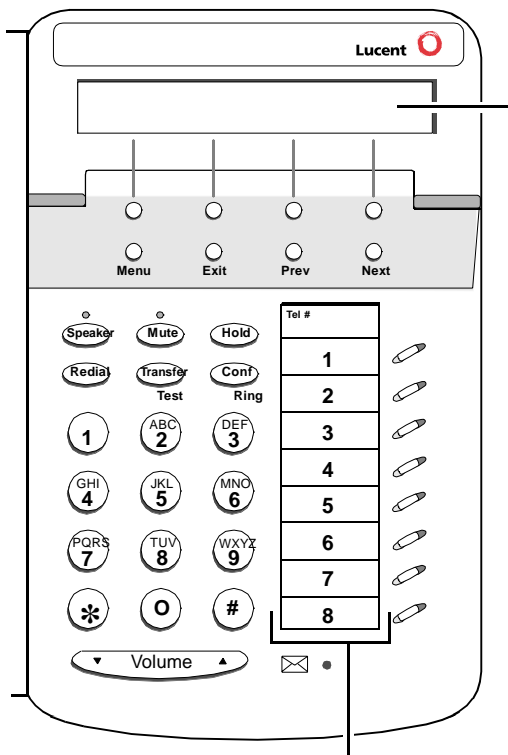

Administer the 12 softkey features on "SOFTKEY BUTTON ASSIGNMENTS" 1 through 12.

The 8 call appearance/feature buttons are administered as "BUTTON ASSIGNMENTS" 1 through 8.

Figure 7-6. Button Numbering for Administering the 6408 Telephones Connected to a DEFINITY System Release 6.1 or Later

### Power Failure Operation

The 6400 Series telephones cannot be used as an emergency station during power failure transfer conditions.

### FCC Registration

The 6400 Series telephones are FCC-registered along with the switch (as a system), but do not have a separate FCC registration label.

## UL and CSA Approval

The 6400 Series telephones have been tested and have met the Underwriters Laboratories (UL) Standards UL 1459 and have also met the Canadian Standards Association (CSA) Standards CSA-C22.2 No.225-M90.

## Hearing Aid Compatible

All 6400 Series telephones are compatible with the inductively coupled hearing aids approved by the FCC.

## 6408 Telephones and Equipment PECs and Comcodes

The 6408 telephones and components can be ordered with these PECs and Comcodes:

- **6408+ (6408D02B) telephone (without a display, with two-way speakerphone)**  
Gray 6408+ Set PEC: 3303-8BG  
Comcode: 108405119;  
White 6408+ Set PEC 3303-8BW  
Comcode: 108405127
- **6408D+ (6408D01B) telephone (with built-in display and two-way speakerphone)**  
Gray 6408D+ Set PEC: 3304-8BG  
Comcode: 108404849;  
White 6408D+ Set PEC: 3304-8BW  
Comcode: 108404872
- **AJ2A Handset**  
Comcode: Gray=220035018; White=220035000
- **Handset cord (9 feet)**  
Comcode: Gray and White cord comcodes not available at this time
- **Line cord (7 feet)**  
PEC: 2725-07G  
Comcode: 103786778
- **Line cord (14 feet, silver)**  
PEC: 2725-07N (COL18)  
Comcode: 103786828
- **Line cord (25 feet, silver)**  
PEC: 2725-07S (COL18)  
Comcode: 103786802
- **Button Designation Card**  
Laser Sheet For 25 Sets  
PEC: 32310A

7 The 6400 Series Telephones  
*The 6408+ and 6408D+ Telephones*

7-24

Comcode: 847770666;  
Laser Sheet For 100 Sets  
PEC: 32311A  
Comcode: 847770674

## Adjuncts

---

The 6408 telephones do NOT have an Adjunct jack on the bottom of the telephone. Therefore, adjunct equipment cannot be used with these telephones.



**NOTE:**

The Headsets mentioned below are plugged into the Handset jack.

## Headsets

A list of compatible headsets, consisting of both modular and plug prong base units and selection of headpieces, appears in "Headset Adapters" in the **Adjuncts** section later in this manual.

## Additional Documents

---

The following documents contain additional information relating to the 6408 telephones: (Use the 9 digit number listed after each document to order that book from the BCS Publications Center for Lucent Technologies.)

- *6408+, 6408D+, 6416D+, and 6424D+ Telephones User's Guide*, 555-230-739
- *6400 Series Multi-line Quick Reference Cards*, 555-104-752



## The 6416D+ and 6416D+M Telephones

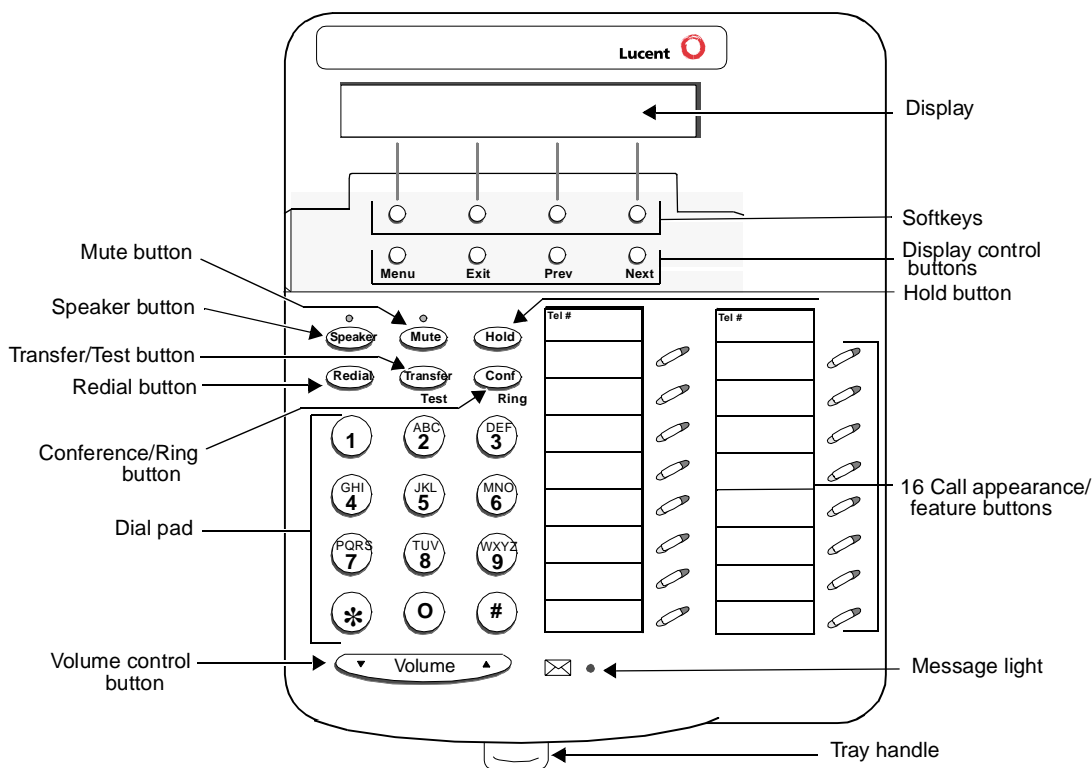

Figure 7-7. The 6416D+ and 6416D+M Telephone

### All 6416D+ and 6416D+M Telephones

The 6416D+ and 6416D+M telephones are multi-appearance digital telephones with 16 call appearance/feature buttons. These telephones also have six standard fixed feature buttons: a SPEAKER button, which can access a 2-way speakerphone, MUTE button to mute the handset or speakerphone microphone, a red HOLD button, REDIAL button, TRANSFER/TEST button for transferring a call or testing the lights and display on the telephone, and a CONF/RING button for setting up a conference call and for selecting a personalized ringing pattern. These telephones also have a red Message light and a Volume control button.

With the 6416D+ and 6416D+M telephones you can access 12 features with the softkeys and display control buttons. These 12 features can be used *in addition to* the features on the call appearance/feature buttons.

 **NOTE:**

The 6416D+ and 6416D+M telephones can work **ONLY** in a 2-wire environment. For more information, see “Wiring Information.”

An XM24 expansion module can be connected to any 6416D+ and 6416D+M telephone to expand the number of buttons you can use. However, when the expansion module is connected, you must connect an auxiliary power supply to the telephone. An 1151A1 local power supply or an 1151A2 local power supply with Battery Holdover is recommended.

## Only the Modular 6416D+M Telephone

In June, 1999, Modular 6416D+M (the 6416D02A) and 6424D+ (the 6424D02A) telephones will also be available. These modular telephones allow you to install a 100A Tip/Ring module in the desktop stand on the telephone for increased set functionality. Through a 6-position RJ11-type jack, the Tip/Ring module provides connection between these two 6400 Series telephone models and such analog adjuncts as answering machines, fax machines, modems, analog speakerphones, and TDD machines commonly used by the hearing impaired.

 **NOTE:**

Only the 6416D+M and 6424D+M models have modular capabilities; that is, the regular non-modular 6416D+M and 6424D+M models do **NOT** have these capabilities.

 **NOTE:**

In order for the Modular 6416D+M and 6424D+M sets to operate, you must connect an auxiliary power supply to the telephone.

For more information about the 100A Tip/Ring Module, refer to “The 100A Tip/Ring Module” in the **Adjuncts** section later in this manual.

## Applications

### All 6416D+ and 6424D+M Telephones

The 6416D+ and 6416D+M telephones can be used with the DEFINITY ECS Release 6.1 and later. These telephones are especially suitable for managers, executive secretaries, and other office support personnel who require access to multiple lines for call handling, call coverage, bridging, conferencing, and sophisticated voice communications. The display on these sets can be used by those who have a need for calling party display capabilities or who require a large number of telephone features.

## Applications for the Modular 6416D+M Telephone Only

If the Modular 6416D+M telephone is being used with a DEFINITY switch, the manner in which the telephone and the analog adjunct interact depends on the switch release to which your telephone is connected. (Your system manager can give you more information about the switch release.)

- On DEFINITY releases prior to Release 8.1, going back to Release 6.1, the analog adjunct shares the telephone line with the telephone. Therefore, while the telephone is being used, you *cannot* use the analog adjunct at the same time, or vice versa.
- On the DEFINITY Release 8.1 and later, the telephone and the analog adjunct can be assigned separate telephone lines, and thus the telephone and analog adjunct can be used *simultaneously*.

## Physical Features

---

### Dimensions



**NOTE:**

The dimensions described here for the 6416D+ and 6416D+M telephones are approximate.

Width = 10.35 inches (26.35 cm)

Depth (front to back) = 8.5 inches (21.59 cm)

Height (with deskstand and handset in place) = 4.75 inches (12.07 cm)

### Features

#### Six Fixed Feature Buttons

The 6416D+ and 6416D+M telephones have the following six fixed feature buttons:

- SPEAKER button
- MUTE button
- HOLD button
- REDIAL button
- TRANSFER/TEST button
- CONFERENCE (labeled CONF)/RING button

## Speaker (Listen-Only) Feature

The 6416D+ and 6416D+M telephones have a two-way speakerphone; however, the telephones can also be optioned instead for a 1-way, listen-only speaker. If this is the case, use the SPEAKER button on the front of the telephone for turning on and off the speaker.

The Speaker (listen-only) capability allows a user to engage in a 1-way conversation with the far-end. Specifically, the user can only listen to the far-end. To speak with the far-end, the user must use the handset which turns off the speaker. The Speaker function may also be disabled.

## Speakerphone

The 6416D+ and 6416D+M telephones are equipped with a built-in 2-way speakerphone. (The telephone can be optioned for a 1-way, listen-only speaker instead. The system manager should have records of how this feature is optioned.) The Speakerphone capability allows a user to engage in a hands-free conversation with the far-end party. The speakerphone can be turned on or off with the SPEAKER button; can be muted with the MUTE button, and the volume can be raised and lowered with the VOLUME "arrow" button.

## MUTE Button

The MUTE button is a fixed feature button with a red status light. The MUTE button turns off the microphone of the built-in speakerphone or the handset so that a person can converse with another person in the room without the other party listening in.

## HOLD Button

The red HOLD button can be used for putting a call on hold. When a call is on hold, the green light next to the held call flashes.

## REDIAL Button

The REDIAL button can be used for redialing the last number you dialed from the dial pad.

## TRANSFER/TEST button

The TRANSFER/TEST button can be used in a couple ways: When the telephone is off-hook, the user can press the TRANSFER button to transfer a call. When the phone is on-hook, the user can use the TRANSFER button to test the lights and the display. (In the latter case, all the display segments fill in.)

## CONFERENCE/RING Button

The CONFERENCE/RING button can be used in a couple ways: When the telephone is off-hook, the user can use this button to set up a conference call with five other people. When the phone is on-hook, the user can press this button to select a personalized ringing pattern from among eight different patterns.

## Call Appearance/Feature Buttons

The 6416D+ and 6416D+M telephones have 16 call appearance/feature buttons, each equipped with a red and a green light. Usually, at least two of these buttons are administered as call appearances for the telephone's primary extension number, where calls are placed and answered. The remainder of the buttons can be used for more call appearances (including bridged appearances of other stations' extensions) and features. Buttons administered for features have only their green status lights active.

## Message Light

The red Message light goes on when a message is left for the user. It goes off when the user retrieves the message or when the message is erased.

## VOLUME Control button

The 6416D+ and 6416D+M telephones have a VOLUME "arrow" button on the front of the set. This button has several functions. When the user is using the speakerphone or the 1-way speaker, the VOLUME button controls the volume of the speaker. When the user is on a call using the handset, the VOLUME button controls the handset volume. When the telephone is idle, the button controls the volume of the tone ringer.

When the user sets the volume for the speaker, speakerphone, handset, or the tone ringer, the display on the 6416D+ telephone shows a "bar array" that indicates the volume setting.

## Display

The display on the 6416D+ and 6416D+M telephones has two lines with 24 characters on each line. The display, along with the softkeys and the display control buttons, can be used to access 12 softkey features. (The default softkey features and the alternative softkey features are listed under "Softkeys.")

## Display Control Buttons

These four buttons are labeled **Menu**, **Exit**, **Prev**, and **Next**.

- The **Menu** button is used to enter Softkey Mode and access the 12 softkey features.
- The **Exit** button is used for exiting a display feature and returning to Normal (call-handling) Mode.
- The **Prev** and **Next** buttons can be used to go back and forth through the feature option screens.

## Softkeys

The four buttons located below the display and labeled with arrows correspond to features listed on the second line of the display screen. (There are four features on each feature option screen.) The user can access any of the 12 features by pressing the softkey below the feature abbreviation.

Below is a list of the 12 default softkey features assigned to the 6416D+ and 6416D+M telephones and the order in which they appear.

**Table 7-5. Default Softkey Features on the 6416D+ and 6416D+M**

Abbreviation	Feature
<b>First Screen</b> <b>Dir*</b>	System Directory
<b>Drop</b>	Drop
<b>HFAns</b>	Internal Auto Answer
<b>Timer</b>	Timer
<b>Second Screen</b> <b>PCall*</b>	Priority Calling
<b>AutCB</b>	Automatic Callback
<b>Prog</b>	Abbreviated Dialing Program
<b>Pause</b>	Abbreviated Dialing Pause
<b>Third Screen</b> <b>LWC</b>	Leave Word Calling
<b>RngOf</b>	Ringer Off
<b>BtnVu</b>	Button Assignment/View
<b>Admin</b>	Self-Administration

\* A Call Display button should be administered, if access to System Directory is provided.

On 6416D+ and 6416D+M telephones connected to a DEFINITY ECS Release 6.1 or later, the system manager can choose to administer alternate features for use with the softkeys. The following table lists some of the alternate softkey features that can be substituted for the default softkey features listed on the previous page.



**NOTE:**

Future releases of the DEFINITY system may provide additional alternate softkey features.



**NOTE:**

The DEFINITY system can download *BLANK* softkey labels for positions where there are no features administered.

**Table 7-6. Alternate Softkey Features on the 6416D+ and 6416D+M Connected to a DEFINITY ECS Release 6.1 and Later**

<b>Abbreviation</b>	<b>Feature</b>
<b>Acct</b>	Account Code Entry
<b>AD</b>	Abbreviated Dialing buttons (can be multiple AD buttons)
<b>CFrwd</b>	Call Forwarding All Calls
<b>CPark</b>	Call Park
<b>CPkUp</b>	Call Pickup
<b>CnLWC</b>	Cancel Leave Word Calling
<b>Cnslt</b>	Consult
<b>Count</b>	ACD Stroke Count
<b>Dpkup</b>	Directed Call Pickup
<b>Excl</b>	Manual Exclusion
<b>GrpPg</b>	Group Paging
<b>IAuto</b>	Intercom Auto
<b>IDial</b>	Intercom Dial
<b>Inspt</b>	Inspect
<b>Mark</b>	AD Special Function Mark
<b>Park</b>	Call Park to other Extensions
<b>SAC</b>	Send All Calls
<b>SFunc</b>	Abbreviated Dialed Special Function
<b>Spres</b>	Abbreviated Dialing Special Function Suppress
<b>Stats</b>	View (ACD) Statistics
<b>Stop</b>	Abbreviation Dialing Indefinite Wait or Stop
<b>Wait</b>	AD Special Function Wait

## Other Physical Features

### Pull-out tray

Five quick reference cards are provided in the tray located under the base of every 6400 Series telephone.

### Handset

The 6416D+ and 6416D+M telephones are equipped with an AJ2A handset which can accept either a handset or a headset.

### Dial pad

The 6416D+ and 6416D+M telephones are equipped with a 12-button touch-tone dial pad. The letters "Q" and "Z" have been added to the appropriate dial pad keys for directory access, and the "5" button on the dial pad has raised bars for visually-impaired users.

### Jacks

The housing of the 6416D+ and 6416D+M telephones has a Line jack and a Handset cord jack located on the back of the housing. These telephones also have an Expansion Module ("XM24") jack on the back of the telephone to allow connection of an XM24 expansion module.

In addition, the Modular 6416D+M telephones have a Headset jack on the back of the telephone. The Handset cord jack can be used for either a headset or a handset; however, the Headset jack can be used only with a headset.

#### NOTE:

When a modular base unit is used with the Headset jack, the handset should remain plugged into the Handset jack.

#### NOTE:

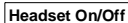
If you plug the headset directly into the Headset jack, you may use a button on the adapter cord, if so equipped, to go off-hook and on-hook, or a  button may be administered.

### Cords

Two cords are supplied with the 6416D+ and 6416D+M telephones: a coiled 9-foot handset cord and a 7-foot line cord.

Optional longer cords are available: a 12-foot handset cord and 14-foot and 25-foot line cords.

In order for the tip/ring module to operate with the Modular 6416D+M telephone, the telephone's desktop stand and the required auxiliary power supply must be connected with an 8-foot D8W cord.



## Ringling

The 6416D+ and 6416D+M telephones have electronic tone ringing with eight possible ringing patterns which you can select by pressing the CONF button while on-hook. The loudness of the tone ringer can be controlled by the VOLUME "arrow" button. (The user must NOT be on a speakerphone call. If the user is using the speakerphone, the VOLUME "arrow" button controls the volume of the speakerphone.)

## Mounting Options

The 6416D+ and 6416D+M telephones come equipped with a nonadjustable desk stand. The user of the 6416D+ can reverse the stand and then mount the telephone on the wall.

However, if there is a module connected in the Modular 6416D+M telephone's desktop stand, the telephone can ONLY be desk mounted: it CANNOT be wall-mounted.

## Color Options

The 6416D+ and 6416D+M telephones are available in gray and in white.

## Wiring Information

The 6416D+ and 6416D+M telephones work in a 2-wire DCP configuration ONLY. The table below describes the pins on a 6400-Series telephone LINE jack.

**Table 7-7. The Pins on a 6400-Series Telephone LINE Jack**

Line Interface			
Pin	Pair	Name	Description
4	1	U-T	2-Wire (Tip)
5	1	U-R	2-Wire (Ring)
7	4	P1-	Adjunct Power -48V
8	4	P2+	Adjunct Power Common

### Notes on 6400 Series 2-Wire Installation and Wiring:

ALL wiring between the PBX and the telephone wall jack MUST consist of twisted-pairs. The line cord must be either a D8W, which consists of 4 twisted-pairs, or a D2R which is a 2-conductor non-twisted pair cord. Only these cord types have been approved by Lucent Technologies. For optimum performance, the line cord length should not extend beyond that originally supplied with the telephone.

**7** The 6400 Series Telephones  
*The 6416D+ and 6416D+M Telephones*

7-34

A D8W modular cord **MUST** be used for all 2-wire installations requiring auxiliary power. If using an auxiliary power supply such as a Lucent Technologies 1151A, it is acceptable to have a D2R cord connected from the wall jack to the LINE jack found on the power supply.

For 2-wire operation, if you need to plug the telephone into a 4-pin or 6-pin wall jack, instead of a standard 8-pin modular jack, refer to the "Line Interface" table above to insure that the wires from the 4-pin or 6-pin wall jack are connected to the correct pins on the telephone "LINE" jack.

The 6400 Series telephones can be connected to either a RJ45x or an RJ11C station jack. If connected to an RJ11C, a 2-wire/4-wire Line Adapter must be installed. This adapter is available to accommodate situations where customers need to upgrade from an analog type RJ11C jack to an 8-wire RJ45x type jack. This adapter only works when using a 6400 Series telephone on either the 2-wire 16-port (TN2181) or the 24-port (TN2224) digital line circuit card.

In 2-wire installations using an RJ45x station jack, PBX connections must be on pins 4 and 5 and auxiliary power must be connected to pins 7 and 8. In 2-wire installations using an RJ11C station jack, PBX connections must be on pins 3 and 4 and auxiliary power must be connected on pins 2 and 5.

**REMOVE ALL CONNECTIONS BETWEEN PAIRS BEFORE CONNECTING THE TELEPHONE.**

## **Appropriate Circuit Packs and Distance Limitations**

---

The 6400 Series telephones can only be connected in a 2-wire mode behind the TN2181 and the TN2224 digital circuit packs. For more information see "Wiring Information" above.

In 2-wire operation, the telephone must be within 5,500 feet of the PBX using 22-gauge wire, within 3,500 feet of the PBX using 24-gauge wire, and within 2,200 feet of the PBX using 26-gauge wire.

## **Power Requirements**

---

The regular (non-modular) 6416D+ telephone receives power from the system and does not require any external power supply. However, if the 6416D+ is connected to an XM24 Expansion Module or if you are using a Modular 6416D+M, there **MUST** be auxiliary power in the form of a local power supply such as an 1151A1 or an 1151A2 with Battery Holdover, or a bulk power supply such as an 1145A or 1145B1.

## Administration

The 6416D+ and 6416D+M telephones can be administered as themselves on a DEFINITY system starting with Release 6.1 software. These telephones will NOT work with any DEFINITY switch release prior to Release 6.1.

### Button Numbering

The following button diagrams of the 6416D+ and 6416D+M telephone will help you administer these telephones connected to a DEFINITY ECS Release 6.1 or later.

If you need more information, refer to *DEFINITY Communications System Generic 3 Implementation*, 555-230-653.

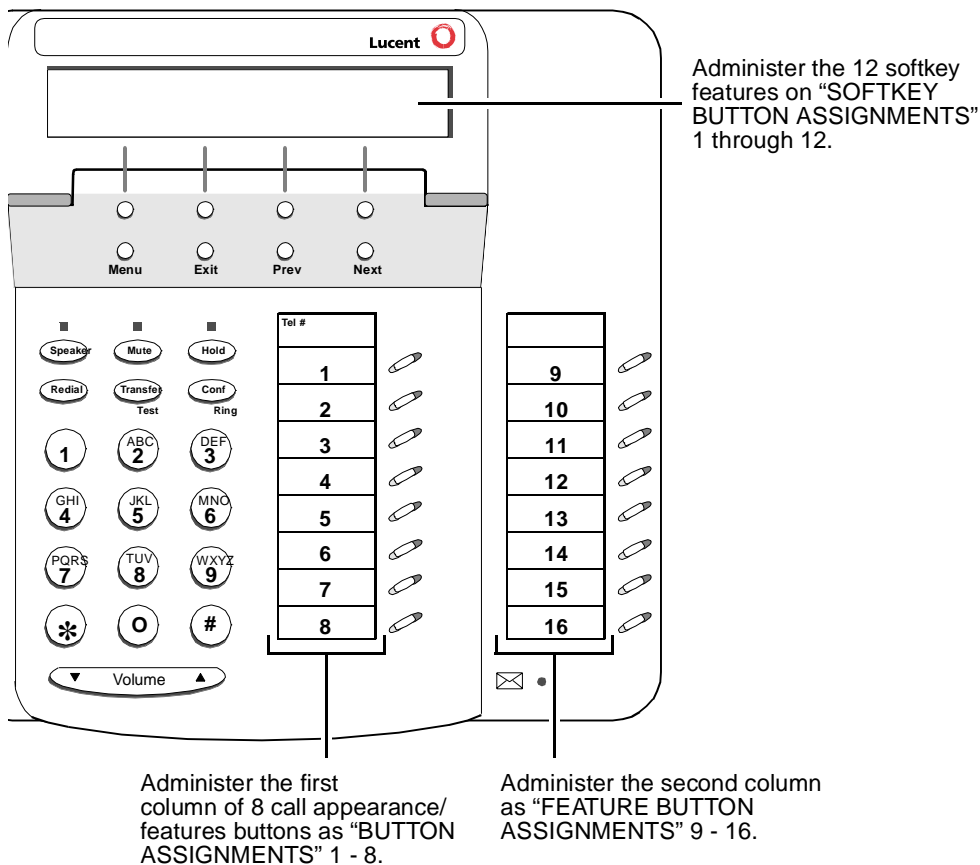

Figure 7-8. Button Numbering for Administering the 6416D+ or 6416D+M Telephone Connected to a DEFINITY System Release 6.1 or Later

## Administering the Analog Adjunct on the Modular 6416D+M Telephone

As noted above, all 6416D+ and 6416D+M can be administered as themselves ONLY IF they are connected to a DEFINITY ECS Release 6.1 (or later). In Native Mode the Modular 6416D+M telephone is administered through a digital line circuit card with a line number (with the usual three call appearances) assigned to the I-1 Channel. If the Modular 6416D+M is connected to a DEFINITY ECS Release 8.1 or later, a second line number can be administered through the same digital line card on the I-2 Channel, but this line number can only be used for analog adjuncts connected to the Tip/Ring module. This analog adjunct is assigned a private number, but can be used only for placing or terminating a call. It cannot be used for any other analog functions such as transferring a call or setting up a conference call. If a second line on the telephone is administered on the I-2-Channel (for analog equipment), type "analog" in the **Data Option** field on the administration screen.

## Power Failure Operation

The 6416D+ and 6416D+M telephones cannot be used as an emergency station during power failure transfer conditions.

## FCC Registration

The 6400 Series telephones are FCC-registered along with the switch (as a system), but do not have a separate FCC registration label.

## UL and CSA Approval

The 6400 Series telephones have been tested and have met the Underwriters Laboratories (UL) Standards UL 1459 and have also met the Canadian Standards Association (CSA) Standards CSA-C22.2 No.225-M90.

## Hearing Aid Compatible

All 6400 Series telephones are compatible with the inductively coupled hearing aids approved by the FCC.

## 6416D+ and 6416D+M Telephones and Equipment PECs and Comcodes

The 6416D+ and 6416D+M telephones and components can be ordered with these PECs and Comcodes:

- **6416D+ (6416D01A) telephone**  
Gray 6416D+ Set PEC: 3306-16G  
Comcode: 108019951;  
White 6416D Set PEC: 3306-16W  
Comcode: 108019845
  - **Modular Class B 6416D+M (6416D02A) telephone**  
Gray 6416D+M Set PEC: 3306-6MG  
Comcode: 108020256;  
White 6416D+M Set PEC: 3306-6MW  
Comcode: 108020157
  - **AJ2A Handset**  
Comcode: Gray=220035018; White=220035000
  - **Handset cord (9 feet)**  
Comcode: Gray and White cord comcodes not available at this time
  - **D8W-87 Line cord (7 feet)**  
PEC: 2725-07G  
Comcode: 103786778
  - **D8W-87 Line cord (14 feet, silver)**  
PEC: 2725-07N (COL18)  
Comcode: 103786828
  - **D8W-87 Line cord (25 feet, silver)**  
PEC: 2725-07S (COL18)  
Comcode: 103786802
  - **D2R-87 Line cord (14 feet)**  
Comcode: 105001861
  - **Button Designation Card**  
Laser Sheet For 25 Sets  
PEC: 32310A  
Comcode: 847770666;  
Laser Sheet For 100 Sets  
PEC: 32311A  
Comcode: 847770674
  - **100A-266 Tip/Ring Module (White)**  
PEC: 3305-TR1  
Comcode: 108332446
- 100A-266 Tip/Ring Module with 1151A Power Supply**  
PEC: 3305-TRP

**7** The 6400 Series Telephones  
*The 6416D+ and 6416D+M Telephones*

7-38

- **XM24 Expansion Module** (for the non-modular 6416D+ and 6424D+)  
Gray XM24 = PEC: 33076/A, Comcode: 108023243  
White XM24 = PEC: 33074/A, Comcode: 108023235
- **XM24 Expansion Module** (with a new base angle for the 6416D+M, 6424D+M, and CALLMASTER V)  
Gray XM24 = PEC: 33071/A, Comcode: 108544511  
White XM24 = PEC: 33072/A, Comcode: 108554503

## Adjuncts

---

The Modular 6416D+M telephones, with the connected 100A Tip/Ring module in the desktop stand, allow connection with such analog adjuncts as answering machines, fax machines, modems, analog speakerphones, and TDD machines commonly used by the hearing impaired. For more information about these connections with the 100A Tip/Ring module, see the **Adjuncts** section later in this manual.

The non-Modular 6416D+ telephones *cannot* accommodate any adjunct equipment.

**NOTE:**

The Headsets mentioned below can be plugged into the Handset jack. On the Modular 6416D+M, there is also a Headset jack to which a headset can be connected.

## Headsets

A list of compatible headsets, consisting of both modular and plug prong base units and selection of headpieces, appears in "Headset Adapters" in the **Adjuncts** section later in this manual.

## Additional Documents

---

The following documents contain additional information relating to the 6416D+ and 6416D+M telephone: (Use the 9 digit number listed after each document to order that book from the BCS Publications Center for Lucent Technologies.)

- *6408+, 6408D+, 6416D+, 6416D+M, 6424D+, and 6424D+M Telephones User's Guide, 555-230-739*
- *6400 Series Multi-line Telephones Quick Reference Cards, 555-104-752*
- *The Tip/Ring Interface Module Installation and User Instructions, 555-233-707.*

## The 6424D+ and 6424D+M Telephone

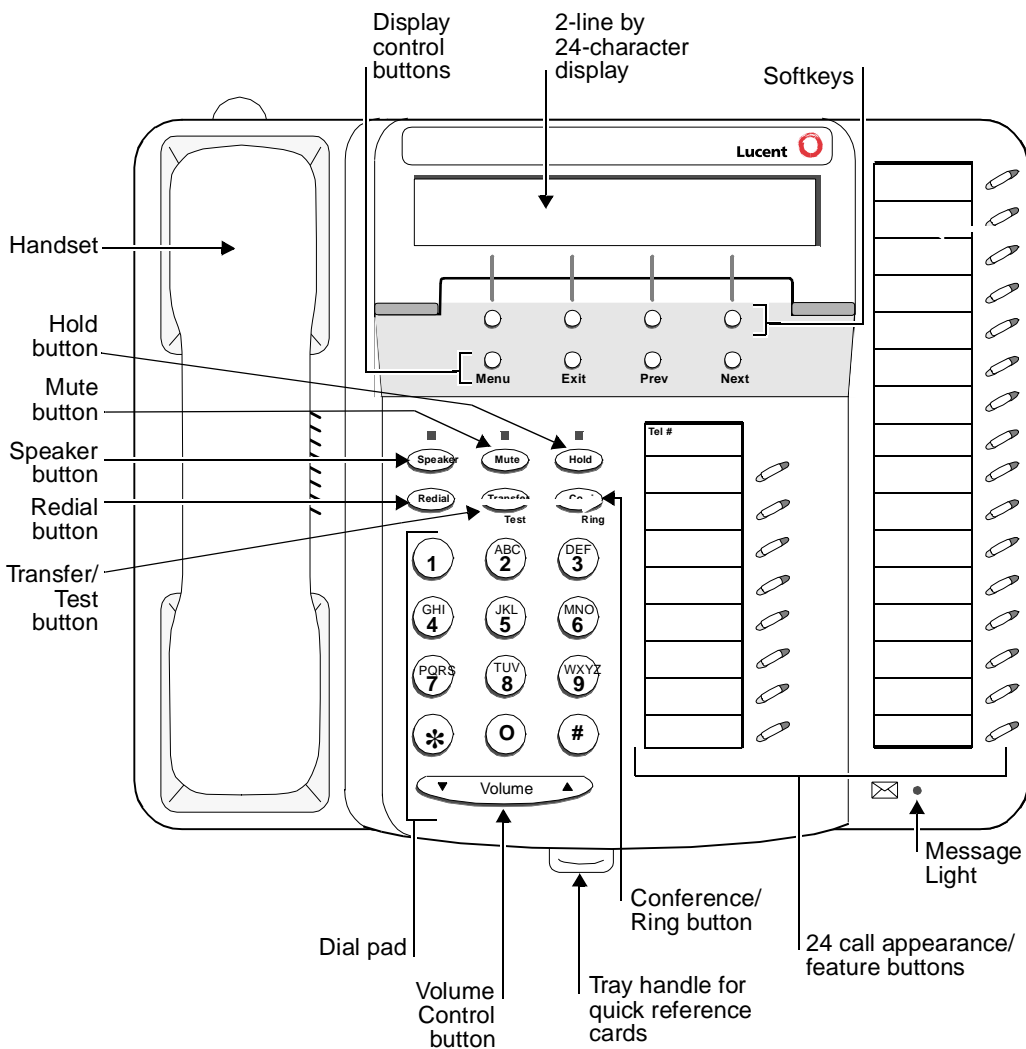

Figure 7-9. The 6424D+ and 6424D+M Telephone

### All 6424D+ and 6424D+M Telephones

The 6424D+ and 6424D+M telephones are multi-appearance digital telephones with 24 call appearance/feature buttons. The telephones also have six standard fixed feature buttons: a SPEAKER button, which can access a 2-way speakerphone, a MUTE button to mute the handset or speakerphone microphone,

**7** The 6400 Series Telephones  
The 6424D+ and 6424D+M Telephone

7-40

a red HOLD button, REDIAL button, TRANSFER/TEST button for transferring a call or testing the lights and display on the telephone, and a CONF/RING button for setting up a conference call and for selecting a personalized ringing pattern. These telephones also have a red Message light and a Volume control button.

With the 6424D+ and 6424D+M telephones you can access 12 features with the softkeys and display control buttons. These 12 features can be used *in addition to* the features on the call appearance/feature buttons.

 **NOTE:**

The 6424D+ and 6424D+M telephones can work **ONLY** in a 2-wire environment. For more information, see “Wiring Information.”

An XM24 expansion module can be connected to any 6424D+ or 6424D+M telephone to expand the number of buttons you can use. However, when the expansion module is connected, you must connect an auxiliary power supply to the telephone. An 1151A1 local power supply or an 1151A2 local power supply with Battery Holdover are recommended.

**Only the Modular 6424D+M**

---

In June, 1999, Modular 6416D+M (6416D02A) and 6424D+M (6424D02A) telephones will also be available. These modular telephones allow you to install a 100A Tip/Ring module in the desktop stand on the telephone for increased set functionality. Through a 6-position RJ11-type jack, the Tip/Ring module provides connection between these two 6400 Series telephone models and such analog adjuncts as answering machines, fax machines, modems, analog speakerphones, and TDD machines commonly used by the hearing impaired.

 **NOTE:**

In order for the Modular 6416D+M and 6424D+M sets to operate, you must connect an auxiliary power supply to the telephone.

For more information about the 100A Tip/Ring Module, refer to “The 100A Tip/Ring Module” in the **Adjuncts** section later in this manual.

**Applications**

---

**All 6424D+ and 6424D+M Telephones**

The 6424D+ and 6424D+M telephones can be used with the DEFINITY ECS Release 6.1 and later. The 6424D+ and 6424D+M telephones are especially suitable for managers, executive secretaries, and other office support personnel who require access to multiple lines for call handling, call coverage, bridging, conferencing, and sophisticated voice communications. The display on these sets can be used by those who have a need for calling party display capabilities or who require a large number of telephone features.



## Applications for the Modular 6424D+M Telephones Only

If the Modular 6424D+M telephone is being used with a DEFINITY switch, the manner in which the telephone and the analog adjunct interact depends on the switch release to which your telephone is connected. (Your system manager can give you more information about the switch release.)

- On DEFINITY Enterprise Communications Server (ECS) releases prior to Release 8.1, going back to Release 6.1, the analog adjunct shares the telephone line with the telephone. Therefore, while the telephone is being used, you *cannot* use the analog adjunct at the same time, or vice versa.
- On the DEFINITY ECS Release 8.1 and later, the telephone and the analog adjunct can be assigned separate telephone lines, and thus the telephone and analog adjunct can be used *simultaneously*.

## Physical Features

---

### Dimensions



**NOTE:**

The dimensions described here for the 6424D+ and 6424D+M telephones are approximate.

Width = 10.35 inches (26.35 cm)

Depth (front to back) = 8.5 inches (21.59 cm)

Height (with deskstand and handset in place) = 4.75 inches (12.07 cm)

### Features

#### Six Fixed Feature Buttons

The 6424D+ and 6424D+M telephones have the following six fixed feature buttons:

- SPEAKER button
- MUTE button
- HOLD button
- REDIAL button
- TRANSFER/TEST button
- CONFERENCE (labeled CONF)/RING button

## Speaker (Listen-Only) Feature

The 6424D+ and 6424D+M telephones have a two-way speakerphone; however, these telephones can also be optioned instead for a 1-way, listen-only speaker. If this is the case, use the SPEAKER button on the front of the telephone for turning on and off the speaker.

The Speaker (listen-only) capability allows a user to engage in a 1-way conversation with the far-end. Specifically, the user can only listen to the far-end. To speak with the far-end, the user must use the handset which turns off the speaker. The Speaker function may also be disabled.

## Speakerphone

The 6424D+ and 6424D+M telephones are equipped with a built-in 2-way speakerphone. (The telephone can be optioned for a 1-way, listen-only speaker instead. The system manager should have records of how this feature is optioned.) The Speakerphone capability allows a user to engage in a hands-free conversation with the far-end party. The speakerphone can be turned on or off with the SPEAKER button; can be muted with the MUTE button, and the volume can be raised and lowered with the VOLUME "arrow" button.

## MUTE Button

The MUTE button is a fixed feature button with a red status light. The MUTE button turns off the microphone of the built-in speakerphone or the handset so that a person can converse with another person in the room without the other party listening in.

## HOLD Button

The red HOLD button can be used for putting a call on hold. When a call is on hold, the green light next to the held call flashes.

## REDIAL Button

The REDIAL button can be used for redialing the last number you dialed from the dial pad.

## TRANSFER/TEST button

The TRANSFER/TEST button can be used in a couple ways: When the telephone is off-hook, the user can press the TRANSFER button to transfer a call. When the phone is on-hook, the user can use the TRANSFER button to test the lights and the display. (In the latter case, all the display segments fill in.)

## CONFERENCE/RING Button

The CONFERENCE/RING button can be used in a couple ways: When the telephone is off-hook, the user can use this button to set up a conference call with five other people. When the phone is on-hook, the user can press this button to select a personalized ringing pattern from among eight different patterns.

## Call Appearance/Feature Buttons

The 6424D+ and 6424D+M telephones have 24 call appearance/feature buttons, each equipped with a red and a green light. Usually, at least two of these buttons are administered as call appearances for the telephone's primary extension number, where calls are placed and answered. The remainder of the buttons can be used for more call appearances (including bridged appearances of other stations' extensions) and features. Buttons administered for features have only their green status lights active.

## Message Light

The red Message light goes on when a message is left for the user. It goes off when the user retrieves the message or when the message is erased.

## VOLUME Control button

The 6424D+ and 6424D+M telephones have a VOLUME "arrow" button on the front of the set. This button has several functions. When the user is using the speakerphone or the 1-way speaker, the VOLUME button controls the volume of the speaker. When the user is on a call using the handset, the VOLUME button controls the handset volume. When the telephone is idle, the button controls the volume of the tone ringer.

When the user sets the volume for the speaker, speakerphone, handset, or the tone ringer, the display on the 6424D+ and 6424D+M telephones shows a "bar array" that indicates the volume setting.

## Display

The display on the 6424D+ and 6424D+M telephones has two lines with 24 characters on each line. The display, along with the softkeys and the display control buttons, can be used to access 12 softkey features. (The default softkey features and the alternative softkey features are listed under "Softkeys.")

## Display Control Buttons

These four buttons are labeled **Menu**, **Exit**, **Prev**, and **Next**.

- The **Menu** button is used to enter Softkey Mode and access the 12 softkey features.
- The **Exit** button is used for exiting a display feature and returning to Normal (call-handling) Mode.
- The **Prev** and **Next** buttons can be used to go back and forth through the feature option screens.

## Softkeys

The four buttons located below the display and labeled with arrows correspond to features listed on the second line of the display screen. (There are four features on each feature option screen.) The user can access any of the 12 features by pressing the softkey below the feature abbreviation.

Below is a list of the 12 default softkey features assigned to the 6424D+ and 6424D+M telephones and the order in which they appear.

**Table 7-8. Default Softkey Features on the 6424D+ and 6424D+M**

Abbreviation	Feature
<b>First Screen Dir*</b>	System Directory
<b>Drop</b>	Drop
<b>HFAns</b>	Internal Auto Answer
<b>Timer</b>	Timer
<b>Second Screen PCall*</b>	Priority Calling
<b>AutCB</b>	Automatic Callback
<b>Prog</b>	Abbreviated Dialing Program
<b>Pause</b>	Abbreviated Dialing Pause
<b>Third Screen LWC</b>	Leave Word Calling
<b>RngOf</b>	Ringer Off
<b>BtnVu</b>	Button Assignment/View
<b>Admin</b>	Self-Administration

---

\* A Call Display button should be administered, if access to System Directory is provided.

---

On 6424D+ and 6424D+M telephones connected to a DEFINITY system Release 6.1 or later, the system manager can choose to administer alternate features for use with the softkeys. The following table lists some of the alternate softkey features that can be substituted for the default softkey features listed on the previous page.

 **NOTE:**  
 Future releases of the DEFINITY system may provide additional alternate softkey features.

 **NOTE:**  
 The DEFINITY system can download *BLANK* softkey labels for positions where there are no features administered.

**Table 7-9. Alternate Softkey Features on the 6424D+ and 6424D+M Connected to a DEFINITY ECS Release 6.1 and Later**

<b>Abbreviation</b>	<b>Feature</b>
<b>Acct</b>	Account Code Entry
<b>AD</b>	Abbreviated Dialing buttons (can be multiple AD buttons)
<b>CFrwd</b>	Call Forwarding All Calls
<b>CPark</b>	Call Park
<b>CPkUp</b>	Call Pickup
<b>CnLWC</b>	Cancel Leave Word Calling
<b>Cnslt</b>	Consult
<b>Count</b>	ACD Stroke Count
<b>Dpkup</b>	Directed Call Pickup
<b>Excl</b>	Manual Exclusion
<b>GrpPg</b>	Group Paging
<b>IAuto</b>	Intercom Auto
<b>IDial</b>	Intercom Dial
<b>Inspt</b>	Inspect
<b>Mark</b>	AD Special Function Mark
<b>Park</b>	Call Park to other Extensions
<b>SAC</b>	Send All Calls
<b>SFunc</b>	Abbreviated Dialed Special Function
<b>Spres</b>	Abbreviated Dialing Special Function Suppress
<b>Stats</b>	View (ACD) Statistics
<b>Stop</b>	Abbreviation Dialing Indefinite Wait or Stop
<b>Wait</b>	AD Special Function Wait

## Other Physical Features

### Pull-out tray

Five quick reference cards are provided in the tray located under the base of every 6400 Series telephone.

### Handset

The 6424D+ and 6424D+M telephones are equipped with an AJ2A handset which can accept either a handset or a headset.

### Dial pad

The 6424D+ and 6424D+M telephones are equipped with a 12-button touch-tone dial pad. The letters "Q" and "Z" have been added to the appropriate dial pad keys for directory access, and the "5" button on the dial pad has raised bars for visually-impaired users.

### Jacks

The housing of the 6424D+ and 6424D+M telephones has a Line jack and a Handset cord jack located on the back of the housing. The 6424D+ also has an Expansion Module ("XM24") jack on the back of the telephone to allow connection of an XM24 expansion module.

The Modular 6424D+M telephones also have a Headset jack on the back of the telephone. The Handset cord jack can be used for either a headset or a handset; however, the Headset jack can be used only with a headset.

#### NOTE:

When a modular base unit is used with the Headset jack, the handset should remain plugged into the Handset jack.

#### NOTE:

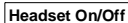
If you plug the headset directly into the Headset jack, you may use a button on the adapter cord, if so equipped, to go off-hook and on-hook, or a  button may be administered.

### Cords

Two cords are supplied with all 6424D+ and 6424D+M telephones: a coiled 9-foot handset cord and a 7-foot line cord.

Optional longer cords are available: a 12-foot handset cord and 14-foot and 25-foot line cords.

In order for the tip/ring module to operate with the Modular 6424D+M telephone, the telephone's desktop stand and the required auxiliary power supply must be connected with an 8-foot D8W cord.

## Ringling

The 6424D+ and 6424D+M telephones have electronic tone ringing with eight possible ringing patterns which you can select by pressing the CONF button while on-hook. The loudness of the tone ringer can be controlled by the VOLUME "arrow" button. (The user must NOT be on a speakerphone call. If the user is using the speakerphone, the VOLUME "arrow" button controls the volume of the speakerphone.)

## Mounting Options

The 6424D+ and 6424D+M telephones come equipped with a nonadjustable desk stand. The user can reverse the stand and then mount the telephone on the wall.

However, if there is a module connected in the Modular 6424D+ telephone's desktop stand, the telephone can ONLY be desk mounted: it CANNOT be wall-mounted.

## Color Options

The 6424D+ and 6424D+M telephones are available in gray and in white.

## Wiring Information

The 6424D+ and 6424D+M telephones work in a 2-wire DCP configuration ONLY. The table below describes the pins on a 6400-Series telephone LINE jack.

**Table 7-10. The Pins on a 6400-Series Telephone LINE Jack**

Line Interface			
Pin	Pair	Name	Description
4	1	U-T	2-Wire (Tip)
5	1	U-R	2-Wire (Ring)
7	4	P1-	Adjunct Power -48V
8	4	P2+	Adjunct Power Common

## Notes on 6400 Series 2-Wire Installation and Wiring:

ALL wiring between the PBX and the telephone wall jack MUST consist of twisted-pairs. The line cord must be either a D8W, which consists of 4 twisted-pairs, or a D2R which is a 2-conductor non-twisted pair cord. Only these cord types have been approved by Lucent Technologies. For optimum performance, the line cord length should not extend beyond that originally supplied with the telephone.

A D8W modular cord MUST be used for all 2-wire installations requiring auxiliary power. If using an auxiliary power supply such as a Lucent Technologies 1151A, it

is acceptable to have a D2R cord connected from the wall jack to the LINE jack found on the power supply.

For 2-wire operation, if you need to plug the telephone into a 4-pin or 6-pin wall jack, instead of a standard 8-pin modular jack, refer to the "Line Interface" table above to insure that the wires from the 4-pin or 6-pin wall jack are connected to the correct pins on the telephone "LINE" jack.

The 6400 Series telephones can be connected to either a RJ45x or an RJ11C station jack. If connected to an RJ11C, a 2-wire/4-wire Line Adapter must be installed. This adapter is available to accommodate situations where customers need to upgrade from an analog type RJ11C jack to an 8-wire RJ45x type jack. This adapter only works when using a 6400 Series telephone on either the 2-wire 16-port (TN2181) or the 24-port (TN2224) digital line circuit card.

In 2-wire installations using an RJ45x station jack, PBX connections must be on pins 4 and 5 and auxiliary power must be connected to pins 7 and 8. In 2-wire installations using an RJ11C station jack, PBX connections must be on pins 3 and 4 and auxiliary power must be connected on pins 2 and 5.

**REMOVE ALL CONNECTIONS BETWEEN PAIRS BEFORE CONNECTING THE TELEPHONE.**

## **Appropriate Circuit Packs and Distance Limitations**

---

The 6400 Series telephones can only be connected in a 2-wire mode behind the TN2181 and the TN2224 digital circuit packs.

In 2-wire operation, the telephone must be within 5,500 feet of the PBX using 22-gauge wire, within 3,500 feet of the PBX using 24-gauge wire, and within 2,200 feet of the PBX using 26-gauge wire.

## **Power Requirements**

---

The regular (non-modular) 6424D+ telephone receives power from the system and does not require any external power supply. However, if the 6424D+ is connected to an XM24 Expansion Module or if you are using a Modular 6424D+M, there **MUST** be auxiliary power in the form of a local power supply such as an 1151A1 or an 1151A2 with Battery Holdover, or a bulk power supply such as an 1145A or 1145B1.

## **Administration**

The 6424D+ and 6424D+M telephones can be administered as themselves on a DEFINITY system starting with Release 6.1 software. This telephone will **NOT** work with any DEFINITY switch release prior to Release 6.1.



## Button Numbering

The following button diagrams of the 6424D+ and 6424D+M telephones will help you administer the 6424D+ and 6424D+M telephone connected to a DEFINITY system Release 6.1 or later.

If you need more information, refer to *DEFINITY Communications System Generic 3 Implementation*, 555-230-653.

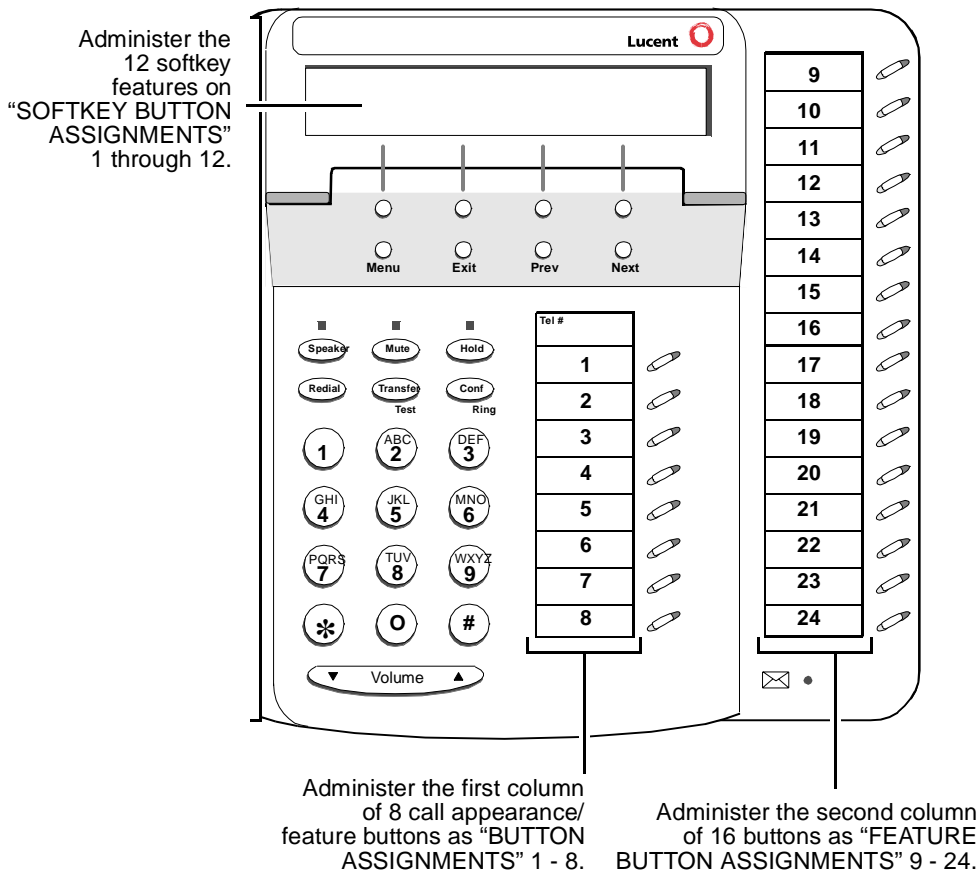

Figure 7-10. Button Numbering for Administering the 6424D+ or 6424D+M Telephone Connected to a DEFINITY System Release 6.1 or Later

## Administering the Analog Adjunct on the Modular 6424D+M Telephone

As noted above, all 6424D+ and 6424D+M telephones can be administered as themselves ONLY IF they are connected to a DEFINITY ECS Release 6.1 (or later). In Native Mode the Modular 6424D+M telephone is administered through a digital line circuit card with a line number (with the usual three call appearances) assigned to the I-1 Channel. If the Modular 6424D+M is connected to a DEFINITY ECS Release 8.1 or later, a second line number can be administered through the same digital line card on the I-2 Channel, but this line number can only be used for analog adjuncts connected to the Tip/Ring module. This analog adjunct is assigned a private number, but can be used only for placing or terminating a call. It cannot be used for any other analog functions such as transferring a call or setting up a conference call. If a second line on the telephone is administered on the I-2-Channel (for analog equipment), type "analog" in the **Data Option** field on the administration screen.

## Power Failure Operation

The 6400 Series telephones cannot be used as an emergency station during power failure transfer conditions.

## FCC Registration

The 6400 Series telephones are FCC-registered along with the switch (as a system), but do not have a separate FCC registration label.

## UL and CSA Approval

The 6400 Series telephones have been tested and have met the Underwriters Laboratories (UL) Standards UL 1459 and have also met the Canadian Standards Association (CSA) Standards CSA-C22.2 No.225-M90.

## Hearing Aid Compatible

All 6400 Series telephones are compatible with the inductively coupled hearing aids approved by the FCC.

## 6424D+ and 6424D+M Equipment PECs and Comcodes

---

The 6424D+ and 6424D+M telephones and components can be ordered with these PECs and Comcodes:

- **6424D+ (6424D01A) telephone**  
Gray 6424D+ Set PEC: 3307-24G  
Comcode: 108020553;  
White 6424D+ Set PEC: 3307-24W  
Comcode: 108020454
  - **Modular Class B 6424D+M (6424D02A) telephone**  
Gray 6424D+M Set PEC: 3307-4MG  
Comcode: 108331240;  
White 6424D+M Set PEC: 3307-4MW  
Comcode: 108331257
  - **AJ2A Handset**  
Comcode: Gray=220035018; White=220035000
  - **Handset cord (9 feet)**  
Comcode: Gray and White cord comcodes not available at this time
  - **D8W-87 Line cord (7 feet)**  
PEC: 2725-07G  
Comcode: 103786778
  - **D8W-87 Line cord (14 feet, silver)**  
PEC: 2725-07N (COL18)  
Comcode: 103786828
  - **D8W-87 Line cord (25 feet, silver)**  
PEC: 2725-07S (COL18)  
Comcode: 103786802
  - **D2R-87 Line cord (14-feet)**  
Comcode: 105001861
  - **Button Designation Card**  
Laser Sheet For 25 Sets  
PEC: 32310A  
Comcode: 847770666;  
Laser Sheet For 100 Sets  
PEC: 32311A  
Comcode: 847770674
  - **100A-266 Tip/Ring Module (White)**  
PEC: 3305-TR1  
Comcode: 108332446
- 100A-266Tip/Ring Module with 1151A Power Supply**  
PEC: 3305-TRP

**7** The 6400 Series Telephones  
*The 6424D+ and 6424D+M Telephone*

7-52

- **XM24 Expansion Module** (for the non-modular 6416D+ and 6424D+)  
Gray XM24 = PEC: 33076/A, Comcode: 108023243  
White XM24 = PEC: 33074/A, Comcode: 108023235
- **XM24 Expansion Module** (with a new base angle for the 6416D+M, 6424D+M, and CALLMASTER V)  
Gray XM24 = PEC: 33071/A, Comcode: 108544511  
White XM24 = PEC: 33072/A, Comcode: 108554503

## Adjuncts

---

The Modular 6424D+M telephones, with the connected 100A Tip/Ring module in the desktop stand, allow connection with such analog adjuncts as answering machines, fax machines, modems, analog speakerphones, and TDD machines commonly used by the hearing impaired. For more information about these connections with the 100A Tip/Ring module, see the **Adjuncts** section later in this manual.

The non-Modular regular 6424D+ telephones *cannot* accommodate any adjunct equipment.

**NOTE:**

The Headsets mentioned below can be plugged into the Handset jack. On the Modular 6424D+M, there is also a Headset jack to which a headset can be connected.

## Headsets

A list of compatible headsets, consisting of both modular and plug prong base units and selection of headpieces, appears in "Headset Adapters" in the **Adjuncts** section later in this manual.

## Additional Documents

---

The following documents contain additional information relating to the 6424D+ telephone: (Use the 9 digit number listed after each document to order that book from the BCS Publications Center for Lucent Technologies.)

- *6408+, 6408D+, 6416D+, 6416D+M, 6424D+, and 6424D+M Telephones User's Guide*, 555-230-739
- *6400 Series Multi-line Quick Reference Cards*, 555-104-752
- *The Tip/Ring Interface Module Installation and User Instructions*, 555-233-707.

## The 7100 Series Voice Terminals

# 8

---

The following section describes these 7100 Series voice terminals:

- 7101A voice terminal
- 7102A and 7102 Plus voice terminals
- 7103A Fixed Feature voice terminal
- 7103A Programmable voice terminal
- 7104A voice terminal

## The 7101A Voice Terminal

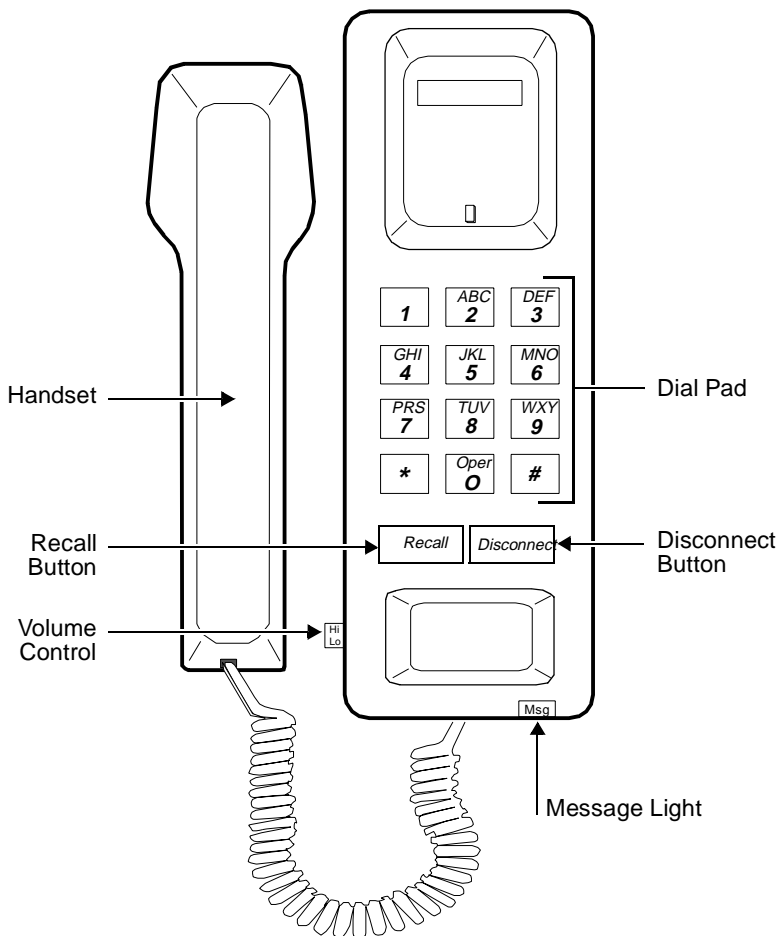

Figure 8-1. The 7101A Voice Terminal

The 7101A voice terminal is a single-line analog model that requires one tip and ring pair for operation. It is equipped with a Message Waiting light and a RECALL button for activating the system's special features. It cannot be physically bridged to the same analog line port due to the message waiting and loop current circuitry.



**NOTE:**

The 7101A has been discontinued.

## **Applications**

---

The 7101A terminal can be used with the DEFINITY Communications System Generic 1, Generic 2, and Generic 3, the DEFINITY ECS, System 75, and System 85. This voice terminal is especially suitable for manufacturing, warehousing, guard and/or reception areas, or office desks where multiple line appearances or one touch access to special features is not required.

## **Physical Description**

---

### **Dimensions**



**NOTE:**

The following dimensions are approximate.

Width = 3-3/4 inches

Depth (front to back) = 8-3/4 inches

Height (maximum with handset in place) = 5-1/2 inches

Thickness of housing = 1-1/2 inches

### **Features**

#### **Two Fixed Feature Buttons**

- RECALL button
- DISCONNECT button

#### **Message Light**

The green Message light goes on when a message is left for the user. It goes off when the user retrieves the message.

### **Other Physical Features**

#### **Handset**

The 7101A is equipped with an R-type handset.

#### **Dial pad**

The 7101A has a 12-button touch-tone dial pad.

## **Jacks**

The 7101A housing contains two jacks. The handset cord jack is just under the left front edge of the housing. (The handset contains a jack for the other end of the handset cord.) The line jack is on the bottom center of the housing.

## **Cords**

Two cords are supplied with the 7101A terminal: a coiled 7-foot modular handset cord and a 7-foot modular line cord. Optional longer cords are available: a 12-foot handset cord, and 14-foot and 25-foot line cords.

## **Ringling**

The 7101A has electronic tone ringling. The volume control is on the left side of the housing.

## **Mounting Options**

The 7101A comes equipped with a non-adjustable desk stand. An optional wall mounting kit may be ordered.

## **Color Options**

The 7101A is available in black only.



**Distance Limitations**

---

The maximum allowable distances of a 7101A from the DEFINITY G1, G2, and G3, DEFINITY ECS, System 75, or System 85 cabinet are shown in the table below.

**Table 8-1. Distance Limitations for the 7101A Voice Terminal**

System	Port Board	Nominal Maximum Range in Feet (Meters)	
		24 AWG	26 AWG
System 85	SN229	3,500 (1,067)	3,500 (1,067)
	SN228B	15,000 (4,572)	9,000 (2,743)
DEFINITY G2	SN229	3,500 (1,067)	3,500 (1,067)
	SN228B	15,000 (4,572)	9,000 (2,743)
	TN742	15,200 (4,633)	10,000 (3,050)
	TN746*	—	—
DEFINITY G1 and G3, DEFINITY ECS, and System 75	TN742	15,200 (4,633)	10,000 (3,050)
	TN769	15,200 (4,633)	10,000 (3,050)
	TN746*	—	—

\* The 7101A cannot be used with the TN746 Port Circuit Pack.

**Power Requirements**

---

The 7101A is powered by the tip and ring leads. It does not require any external power supply.

**Power Failure Operation**

---

The 7101A cannot be used as an emergency station during power failure transfer conditions.

**FCC Registration**

---

The 7101A is not FCC registered.

## **Hearing Aid Compatible**

---

The 7101A voice terminal is compatible with the inductively coupled hearing aids prescribed by the FCC.

## **7101A Equipment PECs**

---

The 7101A Voice Terminal and optional components were ordered with the following PECs:

- Basic 7101A Voice Terminal (black) — 3170-00M
- Handset cord (12 feet, black) — 2725-01L COL09
- Line cord (14 feet, silver) — 2725-07N COL18
- Line cord (25 feet, silver) — 2725-07S COL18

## **Adjuncts**

---

The 7101A does not have an adjunct jack.

## **Additional Documents**

---

The following documents contain additional information relating to the 7101A Voice Terminal:

- *DEFINITY Generic 1 and System 75 7101A Voice Terminal User's Guide*, 555-200-709
- *DEFINITY Generic 2 and System 85 7101A Voice Terminal User's Guide*, 999-700-047
- *DEFINITY Generic 1 and Generic 2, System 75, and System 85 Terminals and Adjuncts Installation and Test*, 555-015-104

## The 7102A and 7102 Plus Voice Terminals

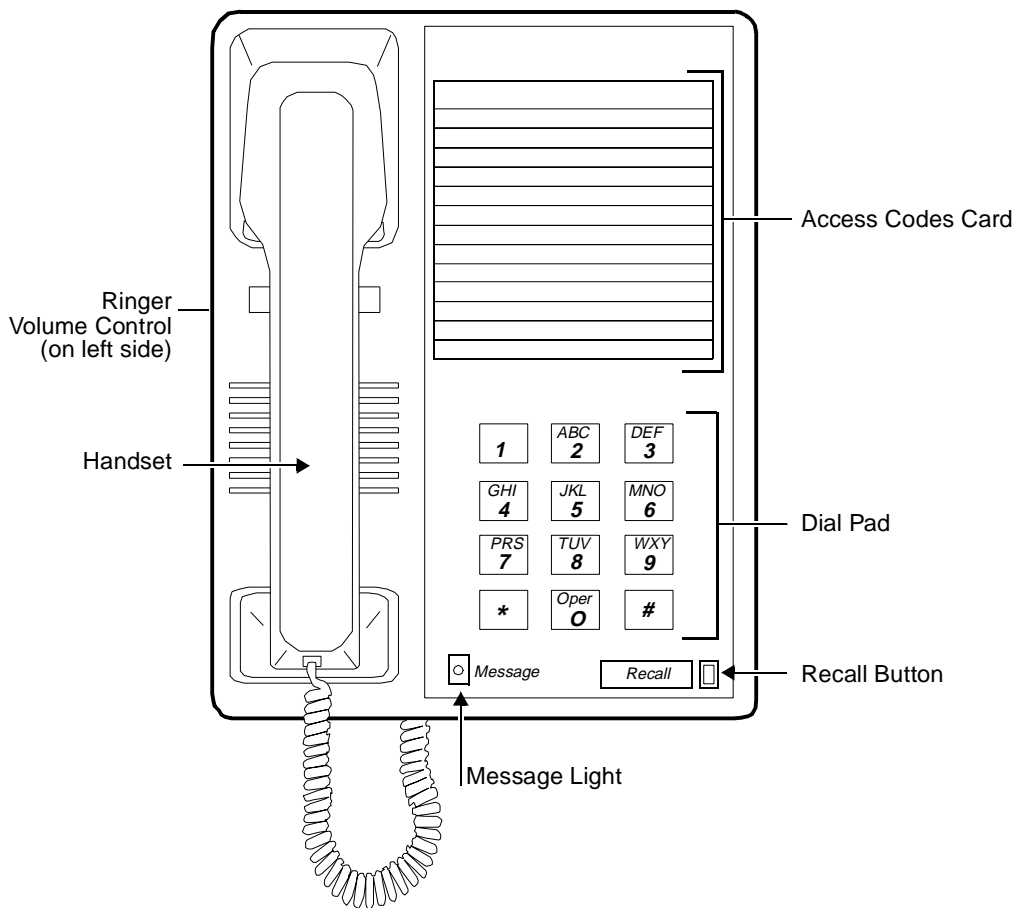

Figure 8-2. The 7102A and 7102 Plus Voice Terminals

The 7102A voice terminal is available in two versions, the 7102A01A and the 710201B, called the 7102 Plus. The front of the two sets is exactly the same in appearance. The only difference is that the 7102A01B is equipped with an adjunct jack. This jack allows speakerphone/headset capability.

The 7102A and the 7102 Plus voice terminals are single-line analog models that require one tip and ring pair for operation. It allows access to system features via the RECALL Button and dial codes. The 7102A and 7102 Plus voice terminal faceplate contains a Feature Access Code Card that can be customized to reflect the most frequently accessed features.



**NOTE:**

Both of the 7102 voice terminals have been discontinued.

## Applications

---

The 7102A and 7102 Plus voice terminals can be used with the DEFINITY Communications System Generic 1, Generic 2, and Generic 3, the DEFINITY ECS, System 75, and System 85. The 7102 voice terminals are especially suitable for manufacturing, warehousing, guard and/or reception areas, or office desks where multiple line appearances or one-touch access to special features is not required.

## Physical Description

---

### Dimensions



**NOTE:**

The following dimensions for the 7102A and the 7102 Plus are approximate.

Width = 7 inches

Depth (front to back) = 8-3/4 inches

Height (maximum with handset in place) = 5-1/2 inches

Thickness of housing = 1-1/2 inches

### Features

#### One Fixed Feature Button

- The RECALL Button

#### Message Light

The red Message light flashes when a message is left for the user. It goes off when the user retrieves the message.

## **Other Physical Features**

### **Handset**

The 7102 voice terminals are equipped with an R-type handset.

### **Dial Pad**

The 7102 voice terminals have a 12-button touch-tone dial pad.

### **Jacks**

The 7102A01A housing contains two jacks. The handset cord jack is just under the center front edge of the housing. (The handset contains a jack for the other end of the handset cord.) The line jack is on the bottom center of the housing.

The 7102 Plus housing contains three jacks. The handset cord jack is just under the center front edge of the housing. (The handset contains a jack for the other end of the handset cord.) The line jack is on the bottom center of the housing. The modular speakerphone/headset jack is located on bottom of the set.

### **Cords**

Two cords are supplied with the 7102 voice terminals: a coiled 7-foot modular handset cord and a 7-foot modular line cord. Optional longer cords are available: a 12-foot handset cord, and 14-foot and 25-foot line cords.

### **Ringling**

The 7102 voice terminals have electronic tone ringling. The volume control is on the left side of the housing.

### **Mounting Options**

The 7102 voice terminals come equipped with both a non-adjustable desk stand and a wall mounting bracket.

### **Color Options**

The 7102 voice terminals are available in two colors: black and misty cream.

## Distance Limitations

The maximum allowable distances of a 7102A or 7102 Plus voice terminal from the DEFINITY G1, G2, and G3, DEFINITY ECS, System 75, or System 85 cabinet are shown in the table below.

**Table 8-2. Distance Limitations for the 7102A and 7102 Plus Voice Terminals**

System	Port Board	Nominal Maximum Range in Feet (Meters)	
		24 AWG	26 AWG
System 85	SN229	3,500 (1,067)	3,500 (1,067)
	SN228B	28,400 (8,662)	17,900 (5,460)
DEFINITY G2	SN229	3,500 (1,067)	3,500 (1,067)
	SN228B	28,400 (8,662)	17,900 (5,460)
	TN742	15,200 (4,633)	10,000 (3,050)
	TN746	3,000 (915)	2,000 (610)
DEFINITY G1 and G3, DEFINITY ECS, and System 75	TN742	15,200 (4,633)	10,000 (3,050)
	TN769	15,200 (4,633)	10,000 (3,050)
	TN746	3,000 (915)	2,000 (610)

## Power Requirements

The 7102 voice terminals are powered by the tip and ring leads. These voice terminals do not require any external power supply.

## Power Failure Operation

The 7102A and the 7102 Plus voice terminals can be used as an emergency station during power failure transfer conditions but will not support any adjuncts.

If the 7102A or 7102 Plus voice terminal is being used as an emergency station for a DEFINITY G1 or G3, DEFINITY ECS, or System 75 that is equipped with a Z1A Emergency Transfer Unit, a ground start switch (551A and 77A bracket) is required. Installation instructions can be found in the *DEFINITY Communications System Generic 1 and Generic 3 Wiring Guide*, 555-204-111.

## FCC Registration

The 7102 voice terminals are FCC registered (AS-593M-17706-TE-T).

## **Hearing Aid Compatible**

---

This voice terminal is compatible with the inductively coupled hearing aids prescribed by the FCC.

## **7102 Equipment PECs**

---

The 7102A and the 7102 Plus voice terminals and optional components were ordered with the following PECs:

- 7102A voice terminal (black and misty cream) — 3185-MWR (not orderable)
- 7102 Plus Voice Terminal (black and misty cream) — 3188-MWS (not orderable)
- Handset cord (12 feet, black) — 2725-01L COL09
- Line cord (14 feet, silver) — 2725-07N COL18
- Line cord (25 feet, silver) — 2725-07S COL18

## **Adjuncts**

---

The 7102A01A cannot be equipped with any adjuncts. The 7102A01B can be equipped with one of the following adjuncts:

- S101A Speakerphone
- S201A Speakerphone
- 500A Headset Adapter with a standard headset

## **Additional Documents**

---

The following documents contain additional information relating to the 7102A voice terminal:

- *DEFINITY Generic 1 7102 Voice Terminal User's Guide, 555-204-728*
- *System 75 7102 Voice Terminal User's Guide, 555-200-728*
- *DEFINITY Generic 2 and System 85 7102 Voice Terminal User's Guide, 555-104-715*
- *DEFINITY Generic 1 and Generic 2, System 75, and System 85 Terminals and Adjuncts Installation and Test, 555-015-104*

## The 7103A Fixed Feature Voice Terminal

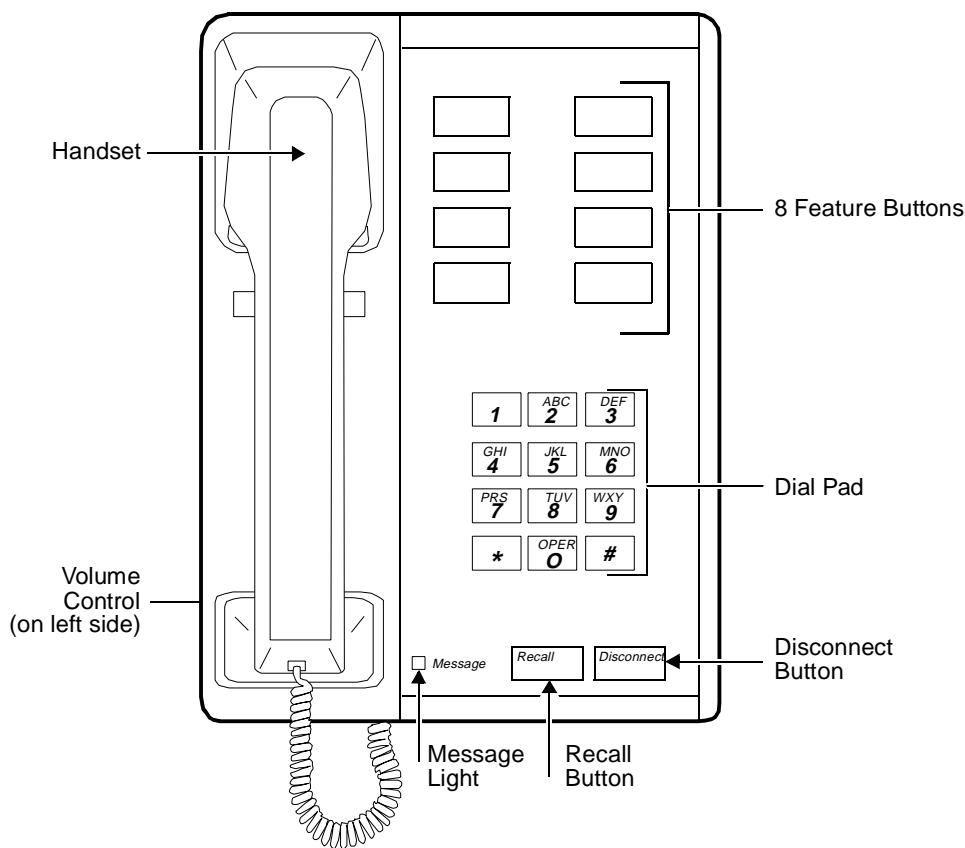

Figure 8-3. The 7103A Fixed Feature Voice Terminal

The 7103A Fixed Feature voice terminal is a single-line analog model. The feature buttons on this terminal must be programmed by the system manager. It requires one tip and ring pair for operation. It cannot be physically bridged to the same analog line port due to the message waiting and loop current circuitry.



**NOTE:**

The 7103A Fixed Feature voice terminal has been discontinued.



## **Applications**

---

The 7103A Fixed Feature voice terminal can be used with the DEFINITY Communications System Generic 1, Generic 2, and Generic 3, the DEFINITY ECS, System 75, and System 85. This voice terminal is especially suitable for groups of office workers who make frequent calls to the same destinations or use the same features.

## **Physical Description**

---

### **Dimensions**



**NOTE:**

The following dimensions are approximate.

Width = 7 inches

Depth (front to back) = 8-3/4 inches

Height (maximum with handset in place) = 5-1/2 inches

Thickness of housing = 1-1/2 inches

### **Features**

#### **Two Fixed Feature Buttons**

- RECALL button
- DISCONNECT button

#### **Eight Feature Buttons**

The system manager designates and programs all buttons, except fixed feature buttons, for the common needs of all voice terminal users. Within any one system, all 7103A Fixed Feature voice terminals have identical features at the same button positions.

#### **Message Light**

The green Message light goes on when a message is left for the user. It goes off when the user retrieves the message.

### **Other Physical Features**

#### **Handset**

The 7103A Fixed Feature voice terminal is equipped with an R-type handset.

## Dial pad

The 7103A Fixed Feature voice terminal has a 12-button touch-tone dial pad.

## Jacks

The 7103A Fixed Feature voice terminal housing contains three jacks. The handset cord jack is just under the left side of the housing. (The handset contains a jack for the other side of the handset cord.) The LINE and OTHER jacks are on the bottom center of the housing.

## Cords

Two cords are supplied with the 7103A Fixed Feature voice terminal: a coiled 7-foot modular handset cord and a 7-foot modular line cord. Optional longer cords are available: a 12-foot handset cord, and 14-foot and 25-foot line cords.

## Ringling

The 7103A Fixed Feature voice terminal has electronic tone ringling. The volume control is on the left side of the housing.

## Mounting Options

The 7103A Fixed Feature voice terminal comes equipped with a nonadjustable desk stand. An adjustable desk stand or a wall mounting bracket can be optionally ordered.

## Color Options

The 7103A Fixed Feature voice terminal is available in black only.

## Distance Limitations

The maximum allowable distances of a 7103A Fixed Feature voice terminal from the DEFINITY G1, G2, and G3, DEFINITY ECS, System 75, or System 85 cabinet are shown in the table below.

**Table 8-3. Distance Limitations for the 7103A Fixed Feature Voice Terminal**

System	Port Board	Nominal Maximum Range in Feet (Meters)	
		24 AWG	26 AWG
System 85	SN229	3,500 (1,067)	3,500 (1,067)
	SN228B	15,000 (4,572)	9,000 (2,743)
DEFINITY G2	SN229	3,500 (1,067)	3,500 (1,067)
	SN228B	15,000 (4,572)	9,000 (2,743)
	TN742	15,200 (4,633)	10,000 (3,050)
	TN746*	—	—
DEFINITY G1 and G3, DEFINITY ECS, and System 75	TN742	15,200 (4,633)	10,000 (3,050)
	TN769	15,200 (4,633)	10,000 (3,050)
	TN746*	—	—

\* The 7103A cannot be used with the TN746 Port Circuit Pack.

## Power Requirements

The 7103A Fixed Feature voice terminal is powered by the tip and ring leads. If the 7103A Fixed Feature voice terminal is equipped with any adjunct, auxiliary power will be required for the adjunct. Refer to the **Adjunct Power** section earlier in this manual.

## Power Failure Operation

The 7103A Fixed Feature voice terminal cannot be used as an emergency station during power failure transfer conditions.

## FCC Registration

The 7103A Fixed Feature voice terminal is not FCC registered.

## **Hearing Aid Compatible**

---

The 7103 Fixed Feature voice terminal is compatible with the inductively coupled hearing aids prescribed by the FCC.

## **7103A (Fixed Feature) Equipment PECs**

---

The 7103A Fixed Feature voice terminal and optional components were ordered with the following PECs:

- Basic 7103A Fixed Feature Voice Terminal — (not orderable)
- Handset cord (12 feet, black) — 2725-01L COL09
- Line cord (14 feet, silver) — 2725-07N COL18
- Line cord (25 feet, silver) — 2725-07S COL18

## **Adjuncts**

---

One of the following adjuncts can be used with this voice terminal:

- S101A Speakerphone
- S201A Speakerphone
- 500A Headset Adapter with a standard headset

## **Additional Documents**

---

The following documents contain additional information relating to the 7103A Fixed Feature voice terminal:

- *DEFINITY Generic 1 and System 75 7103A Voice Terminal User's Guide*, 555-200-710
- *DEFINITY Generic 2 and System 85 7103A Voice Terminal User's Guide*, 999-700-048
- *DEFINITY Generic 1 and Generic 2, System 75, and System 85 Terminals and Adjuncts Installation and Test*, 555-015-104

## The 7103A Programmable Voice Terminal

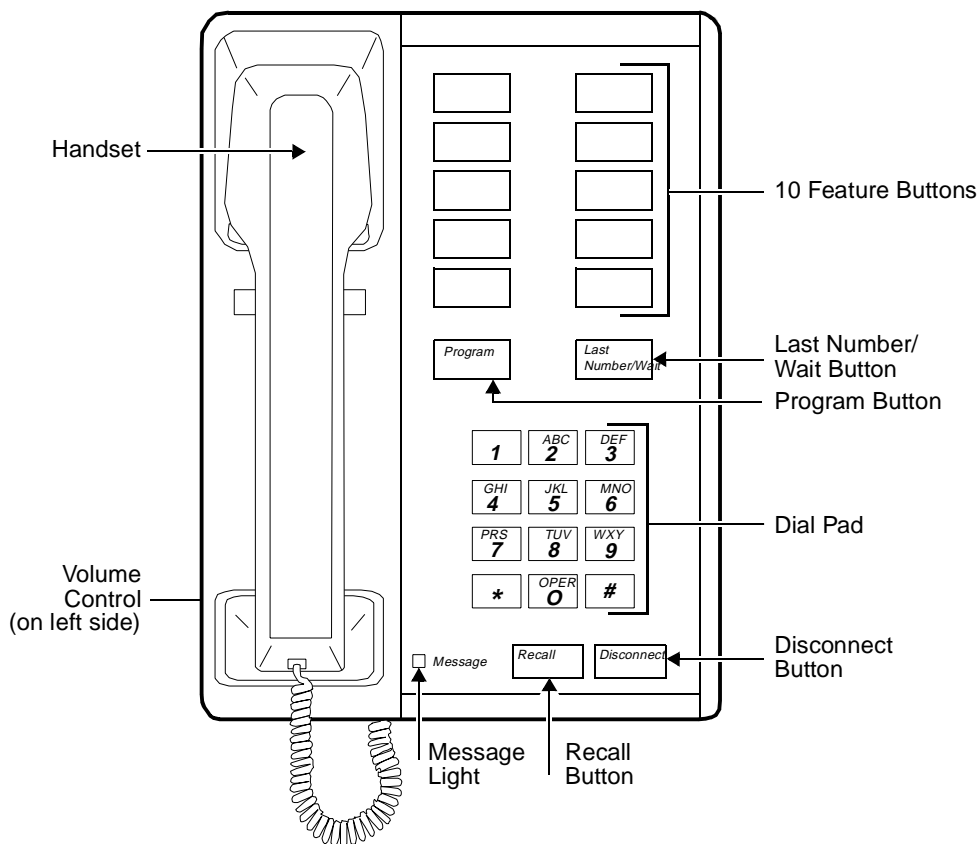

Figure 8-4. The 7103A Programmable Voice Terminal

The 7103 Programmable voice terminal is a single-line analog model. The 10 feature buttons can be programmed by the user for one-touch feature access or for one-touch Speed Dialing. It requires one tip and ring pair for operation. It cannot be physically bridged to the same analog line port due to the message waiting and loop current circuitry.



**NOTE:**

The 7103 Programmable voice terminal is no longer manufactured. However, some remanufactured terminals may still be ordered.

## Applications

---

The 7103A Programmable voice terminal can be used with the DEFINITY Communications System Generic 1, Generic 2, and Generic 3, the DEFINITY ECS, System 75, and System 85. This voice terminal is especially suitable for groups of office workers who make frequent calls to the same destinations or use the same features.

## Physical Description

---

### Dimensions



**NOTE:**

The following dimensions are approximate.

Width = 7 inches

Depth (front to back) = 8-3/4 inches

Height (maximum with handset in place) = 5-1/2 inches

Thickness of housing = 1-1/2 inches

### Features

#### Four Fixed Feature Buttons

- RECALL button
- DISCONNECT button
- LAST NUMBER/WAIT button — This is a dual function button. In its normal (Last Number) mode, this button is used to automatically redial the last number dialed; in the Wait mode, it is used to enter a delay in a number being stored on a feature button.
- PROGRAM button — This button is used to enter mode for programming feature buttons for feature access or for Repertory Dialing. With the Repertory Dialing feature, the terminal user can store in-house or external numbers. Operation of this button also puts the Last Number/Wait button into the Wait mode.

#### Ten User-Programmable Feature Buttons

The 10 programmable buttons allow each user to enter often-used telephone numbers or choose the most desirable features provided by the system.

## **Message Light**

The green Message light goes on when a message is left for the user. It goes off when the user retrieves the message.

## **Other Physical Features**

### **Handset**

The 7103A Programmable voice terminal is equipped with an R-type handset.

### **Dial pad**

The 7103A Programmable voice terminal has a 12-button touch-tone dial pad.

### **Jacks**

The 7103A Programmable voice terminal housing contains three jacks. The handset cord jack is just under the left side of the housing. (The handset contains a jack for the other end of the handset cord.) The LINE and OTHER jacks are on the bottom center of the housing.

### **Cords**

Two cords are supplied with the 7103A Programmable voice terminal: a coiled 7-foot modular handset cord and a 7-foot modular line cord. Optional longer cords are available: a 12-foot handset cord, and 14-foot and 25-foot line cords.

### **Ringling**

The 7103A Programmable voice terminal has electronic tone personalized ringling. The personalized ringling is controlled by two ring switches on the bottom of the voice terminal. The volume control is on the left side of the housing.

### **Mounting Options**

The 7103A Programmable voice terminal comes equipped with a nonadjustable desk stand. An adjustable desk stand or a wall mounting bracket can be optionally ordered.

### **Color Options**

The 7103A Programmable voice terminal is available in black only.

## Distance Limitations

The maximum allowable distances of a 7103A Programmable voice terminal from the DEFINITY G1, G2, and G3, DEFINITY ECS, System 75, or System 85 cabinet are shown in the table below.

**Table 8-4. Distance Limitations for the 7103A Programmable Voice Terminal**

System	Port Board	Nominal Maximum Range in Feet (Meters)	
		24 AWG	26 AWG
System 85	SN229	3,500 (1,067)	3,500 (1,067)
	SN228B	15,000 (4,572)	9,000 (2,743)
DEFINITY G2	SN229	3,500 (1,067)	3,500 (1,067)
	SN228B	15,000 (4,572)	9,000 (2,743)
	TN742	15,200 (4,633)	10,000 (3,050)
	TN746*	—	—
DEFINITY G1 and G3, DEFINITY ECS, and System 75	TN742	15,200 (4,633)	10,000 (3,050)
	TN769	15,200 (4,633)	10,000 (3,050)
	TN746*	—	—

\* The 7103A cannot be used with the TN746 Port Circuit Pack.

## Power Requirements

The 7103A Programmable voice terminal is powered by the tip and ring leads. If the 7103A voice terminal is equipped with any adjunct, auxiliary power will be required for the adjunct. Refer to the **Adjunct Power** section earlier in this manual.

## Power Failure Operation

The 7103A Programmable voice terminal cannot be used as an emergency station during power failure transfer conditions.

## FCC Registration

The 7103A Programmable voice terminal is not FCC registered.



## **Hearing Aid Compatible**

---

The 7103A Programmable voice terminal is compatible with the inductively coupled hearing aids prescribed by the FCC.

## **7103A (Programmable) Equipment PECs**

---

The 7103A Programmable voice terminal and optional components were ordered with the following PECs:

- Basic 7103A Programmable Voice Terminal — 3171-14F
- Handset cord (12 feet, black) — 2725-01L COL09
- Line cord (14 feet, silver) — 2725-07N COL18
- Line cord (25 feet, silver) — 2725-07S COL18

## **Adjuncts**

---

One of the following adjuncts can be used with this voice terminal:

- S101A Speakerphone
- S102A Speakerphone
- 500A Headset Adapter with a standard headset

## **Additional Documents**

---

The following documents contain additional information relating to the 7103A Programmable voice terminal:

- *DEFINITY Generic 1 and System 75 7103A Voice Terminal User's Guide*, 555-200-717
- *DEFINITY Generic 2 and System 85 7103A Voice Terminal User's Guide*, 999-700-464
- *DEFINITY Generic 1 and Generic 2, System 75, and System 85 Terminals and Adjuncts Installation and Test*, 555-015-104

# The 7104A Voice Terminal

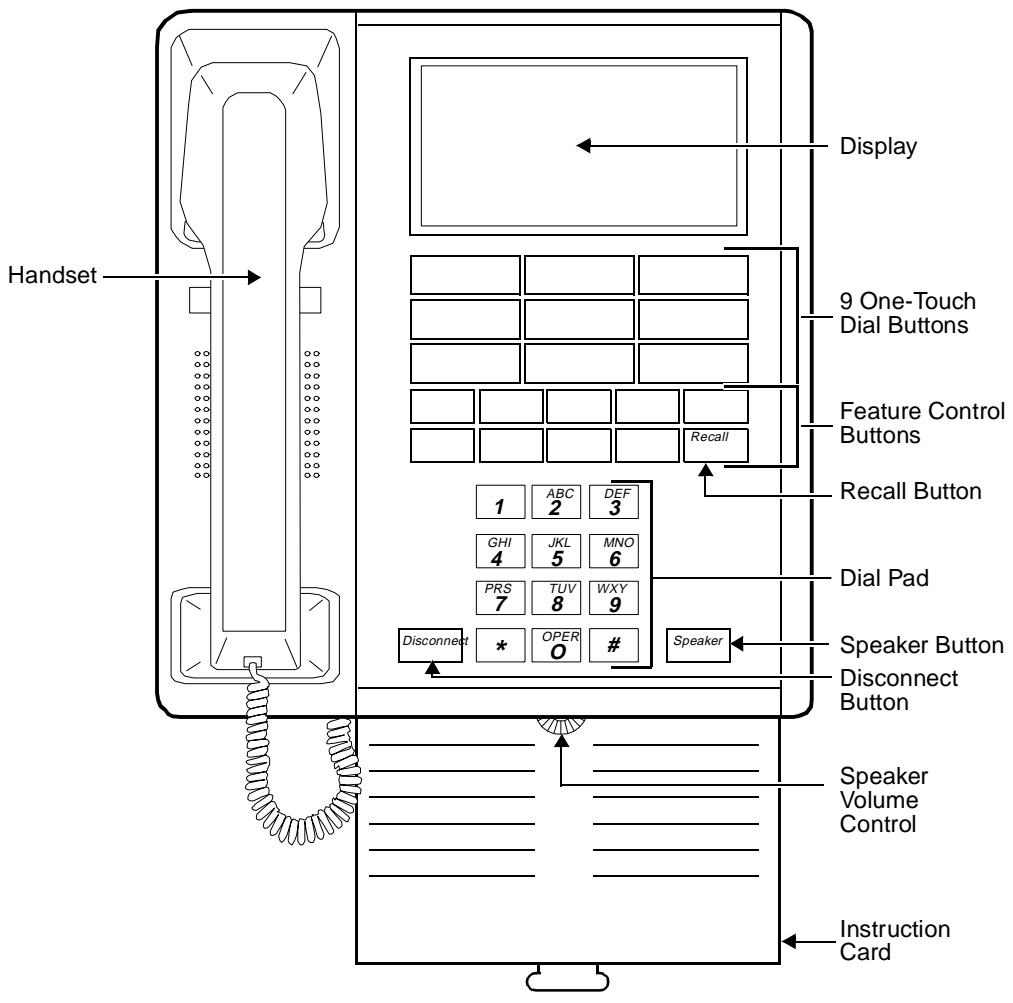

Figure 8-5. The 7104A Voice Terminal

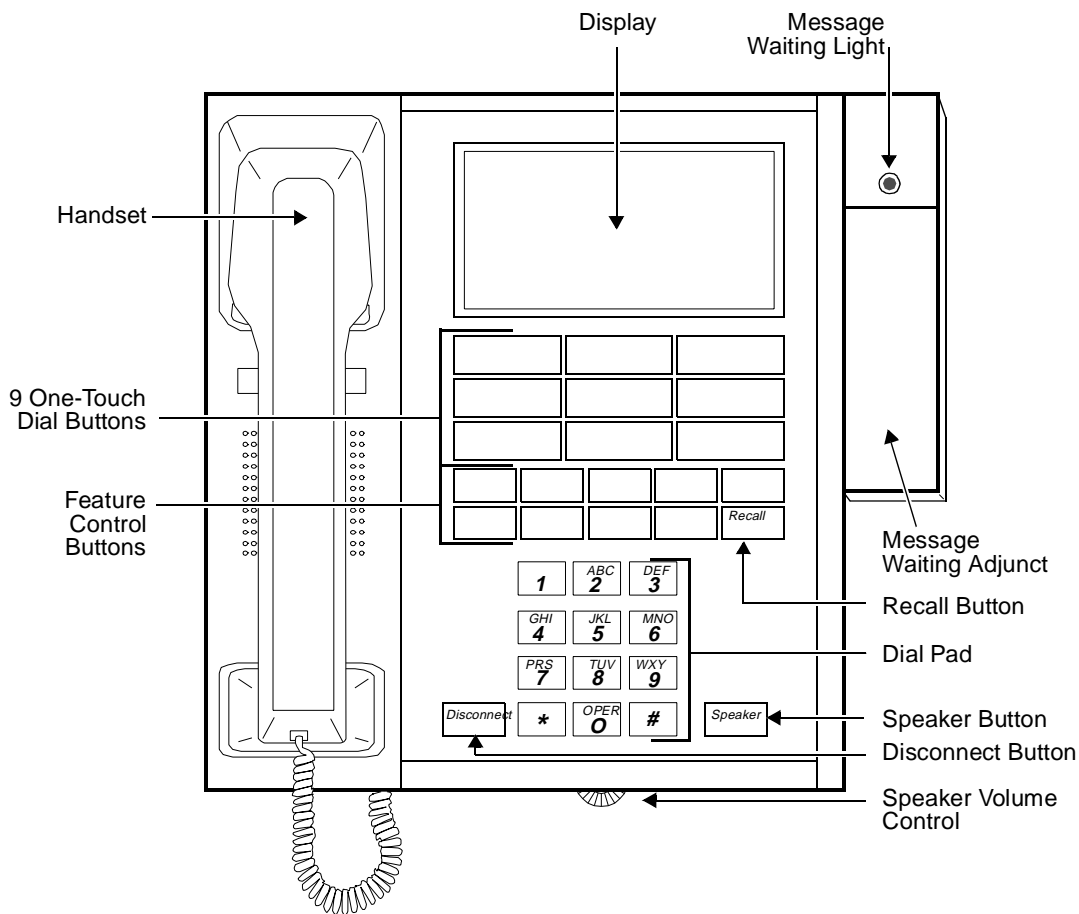

Figure 8-6. The 7104A Voice Terminal with Attached Message Waiting Adjunct

The 7104A voice terminal is a single-line analog model. This voice terminal is equipped with a display that is used to display stored numbers. It requires one tip and ring pair for operation. It cannot be physically bridged to the same analog line port due to the message waiting and loop current circuitry.

**NOTE:**

The 7104A voice terminal is no longer manufactured. However, some remanufactured terminals may still be ordered.

## Applications

---

The 7104A voice terminal can be used with the DEFINITY Communications System Generic 1 and Generic 3, the DEFINITY ECS, and System 75. This voice terminal is especially suitable for managers, office support personnel, and others.

## Physical Description

---

### Dimensions



**NOTE:**

The following dimensions are approximate.

Width = 8 inches

Depth (front to back) = 8-3/4 inches

Height (maximum with handset in place) = 5-1/2 inches

Thickness of housing = 1-1/2 inches

### Features

#### Two Fixed Feature Buttons

- RECALL button
- DISCONNECT button

#### Eight Special Fixed Feature Buttons

- SHIFT button — used for toggling between the two modes of the following four dual function feature buttons and the eight dual function one-touch dialing buttons
- SET CLOCK/TIMER button — used for setting time and for timing a call
- AM/DLYD RING button — used in time-setting procedure and to delay ringing on incoming calls
- PM/ABRV RING button — used in time-setting procedure and to provide abbreviated ringing on incoming calls

- SAVE/SEND button — used to save a dialed number, then call it again
- PROGRAM button — used in recording numbers for one-touch dialing
- DISPLAY button — used to display stored numbers
- SPACE, PAUSE, and STOP buttons — used in recording numbers for one-touch dialing

### Eight dual function buttons

These buttons are divided into gray and blue halves and can be programmed for one-touch dialing of sixteen frequently called numbers and/or system features.

### Loudspeaker

The 7104A voice terminal has a built in loudspeaker for group listening and on-hook dialing. The loudspeaker can be turned on and off with the SPEAKER button.

### Display

A 14-Character Liquid Crystal Display (LCD) provides the following displays. Each display is local to the individual terminal.

Abbreviated Ring mode in effect	Number programmed
Date	Program mode in effect
Delayed Ring mode in effect	Shift mode in effect
Display mode in effect	Speaker on
Low Battery	Time
Number called	

### Pull out tray

The 7104A voice terminal is equipped with a pull out tray with an instruction card for voice terminal operation.

## Other Physical Features

### Handset

The 7104A voice terminal is equipped with an R-type handset.

### Dial pad

The 7104A voice terminal has a 12-button touch-tone dial pad.

### Jacks

The 7104A voice terminal housing contains two jacks. The handset cord jack is just under the left side of the housing. (The handset contains a jack for the other end of the handset cord.) The line jack is on the bottom center of the housing.

### Cords

Two cords are supplied with the 7104A voice terminal: a coiled 7-foot modular handset cord and a 7-foot modular line cord. Optional longer cords are available: a 12-foot handset cord, and 14-foot and 25-foot line cords.

### Ringling

The 7104A voice terminal has electronic tone personalized ringing. The personalized ringing is controlled by a ring switch under the rear end cap of the voice terminal. The volume control is on the left side of the housing.

### Mounting Options

The 7104A voice terminal comes equipped with a nonadjustable desk stand.

### Color Options

The 7104A voice terminal is available in three colors: black, misty cream, and chocolate brown.

## Distance Limitations

The maximum allowable distances of a 7104A voice terminal from the DEFINITY G1 and G3, DEFINITY ECS, and System 75 cabinet are shown in the table below.

**Table 8-5. Distance Limitations for the 7104A Voice Terminal**

System	Port Board	Nominal Maximum Range in Feet (Meters)	
		24 AWG	26 AWG
DEFINITY G1 and G3, DEFINITY ECS, and SYSTEM 75	TN742	15,200 (4,633)	10,000 (3,050)
	TN769	15,200 (4,633)	10,000 (3,050)
	TN746	3,000 (915)	2,000 (610)

## Power Requirements

The 7104A voice terminal is powered by the tip and ring leads. Battery power is used for some circuits during the on-hook state when loop current is not available. The battery power is provided by four 1.5 volt AA batteries. The batteries are contained in a battery pack that is accessed through the rear end cap.

## Power Failure Operation

The 7104A voice terminal cannot be used as an emergency station during power failure transfer conditions.

## **FCC Registration**

---

The 7104A voice terminal is not FCC registered.

## **Hearing Aid Compatible**

---

The 7104A voice terminal is compatible with the inductively coupled hearing aids prescribed by the FCC.

## **7104A Equipment PECs**

---

The 7104A voice terminal and optional components were ordered with the following PECs:

- Basic 7104A Voice Terminal (black, misty cream, and chocolate brown) — 3150-010
- Handset cord (12 feet, black) — 2725-01L COL09
- Line cord (14 feet, silver) — 2725-07N COL18
- Line cord (25 feet, silver) — 2725-07S COL18

## **Adjuncts**

---

The optional Z34A Message waiting Adjunct can be used with the 7104A voice terminal to provide a visual message waiting indication.

## **Additional Documents**

---

The following documents contain additional information relating to the 7104A voice terminal:

- *DEFINITY Generic 1 and System 75 7104A Voice Terminal User's Guide*, 555-015-720
- *DEFINITY Generic 1 and Generic 2, System 75, and System 85 Terminals and Adjuncts Installation and Test*, 555-015-104

**8** The 7100 Series Voice Terminals  
*The 7104A Voice Terminal*

*8-28*



## The 7200 Series Voice Terminals

# 9

---

This section describes the following 7200 Series voice terminals:

- 7203H voice terminal
- 7205H voice terminal

## The 7203H Voice Terminal

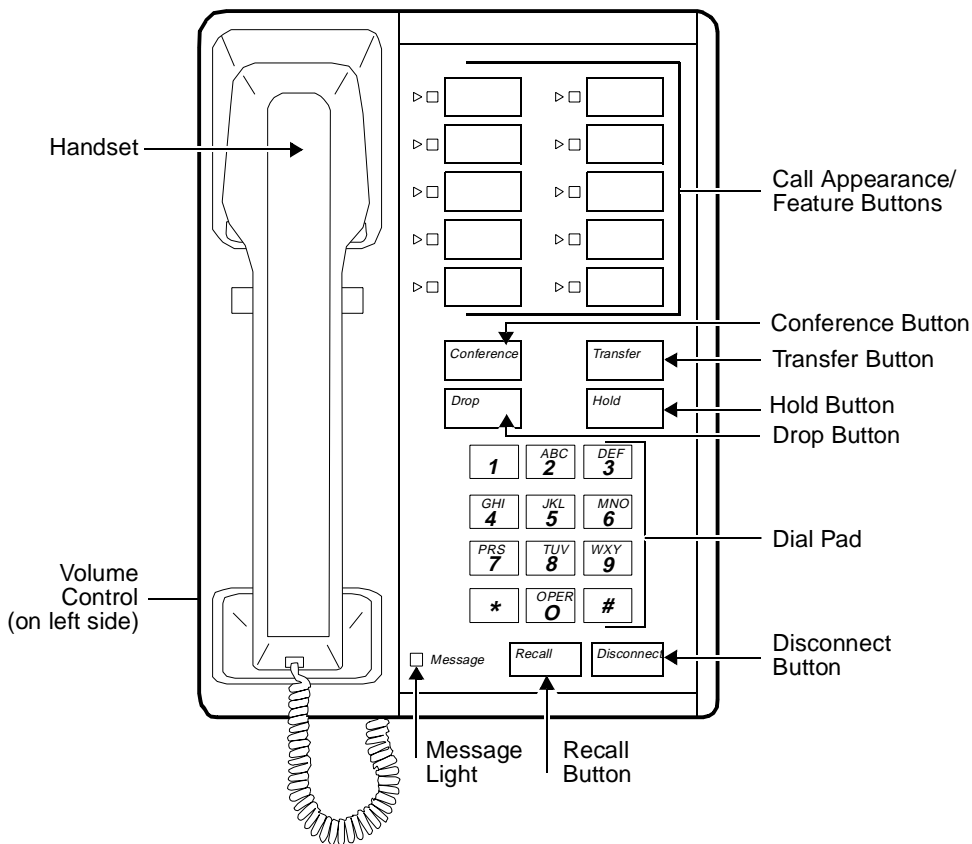

Figure 9-1. The 7203H Voice Terminal

The 7203H voice terminal is a multi-appearance hybrid voice terminal which provides up to 10 incoming lines. Buttons not used for line appearances may be used for one-touch feature access or for Speed Dialing. It requires three pair wiring for operation. One wire pair is used for analog voice, while the other two pairs are used for digital control and signaling.



**NOTE:**

The 7203H voice terminal was discontinued in March 1988.

## Applications

---

The 7203H voice terminal can be used with System 85 and the DEFINITY Communications System Generic 2. However, on a DEFINITY G2, this voice terminal can only be used on a traditional module and the SN224 circuit pack. The 7203H voice terminal is suitable for managers, executive secretaries, office support personnel, and others who do not need data capabilities.

## Physical Description

---

### Dimensions



**NOTE:**

The following dimensions are approximate.

Width = 7 inches

Depth (front to back) = 8-3/4 inches

Height (maximum with handset in place) = 5-1/2 inches

Thickness of housing = 1-1/2 inches

### Features

#### Six Fixed Feature Buttons

- RECALL button
- DISCONNECT button
- CONFERENCE button
- DROP button
- TRANSFER button
- HOLD button

#### Message Light

The green Message light goes on when a message is left for the user. It goes off when the user retrieves the message.

#### Call Appearance/Feature Buttons

The 7203H voice terminal has 10 call appearance/feature buttons. Adjacent to each button is a pair of red and green status indicator lights.

## **Other Physical Features**

### **Handset**

The 7203H voice terminal is equipped with an R-type handset.

### **Dial pad**

The 7203H voice terminal has a 12-button touch-tone dial pad.

### **Jacks**

The 7203H voice terminal housing contains three jacks. The handset cord jack is just under the left side of the housing. (The handset contains a jack for the other end of the handset cord.) The line jack is on the bottom center of the housing. The modular speakerphone/handset jack is located on the bottom of the set.

### **Cords**

Two cords are supplied with the 7203H voice terminal: a coiled 7-foot modular handset cord and a 7-foot modular line cord. Optional longer cords are available: a 12-foot handset cord, and 14-foot and 25-foot line cords.

### **Ringling**

The 7203H voice terminal has electronic tone ringling. The volume control is on the left side of the housing.

### **Mounting Options**

The 7203H voice terminal comes equipped with a nonadjustable desk stand. An optional wall mounting kit can be ordered.

### **Color Options**

The 7203H voice terminal was available in various colors; however, maintenance replacements are available in black only.

## Distance Limitations

The maximum allowable distances of a 7203H voice terminal from the DEFINITY G2 and System 85 cabinet are shown in the following table.

**Table 9-1. Distance Limitations for the 7203H Voice Terminal**

System	Port Board	Nominal Maximum Range in Feet (Meters)	
		24 AWG	26 AWG
DEFINITY G2 and System 85	SN224	3,000 (914)	2,300 (700)

## Power Requirements

The 7203H voice terminal is powered by the tip and ring leads. If the 7203H is equipped with any adjunct, auxiliary power will be required for the adjunct. Refer to the **Adjunct Power** section earlier in this manual.

## Power Failure Operation

The 7203H voice terminal cannot be used as an emergency station during power failure transfer conditions.

## FCC Registration

The 7203H voice terminal is not FCC registered.

## Hearing Aid Compatible

The 7203H voice terminal is compatible with the inductively coupled hearing aids prescribed by the FCC.

## 7203H Equipment PECs

The 7203H voice terminal and optional components were ordered with the following PECs:

- Basic 7203H Voice Terminal — 3182-16H/CLR
- Handset cord (12 feet) — 2725-01L COL09
- Line cord (14 feet, silver) — 2725-07N COL18
- Line cord (25 feet, silver) — 2725-07S COL18

**9** The 7200 Series Voice Terminals  
*The 7203H Voice Terminal*

9-6

## **Adjuncts**

---

One of the following adjuncts can be used with this voice terminal:

- S101A Speakerphone
- S201A Speakerphone
- 500A Headset Adapter and a standard headset

## **Additional Documents**

---

The following documents contain additional information relating to the 7203H voice terminal:

- *System 85 7203H Voice Terminal User's Guide, 555-102-709*
- *DEFINITY Generic 1 and Generic 2, System 75, and System 85 Terminals and Adjuncts Installation and Test, 555-015-104*

## The 7205H Voice Terminal

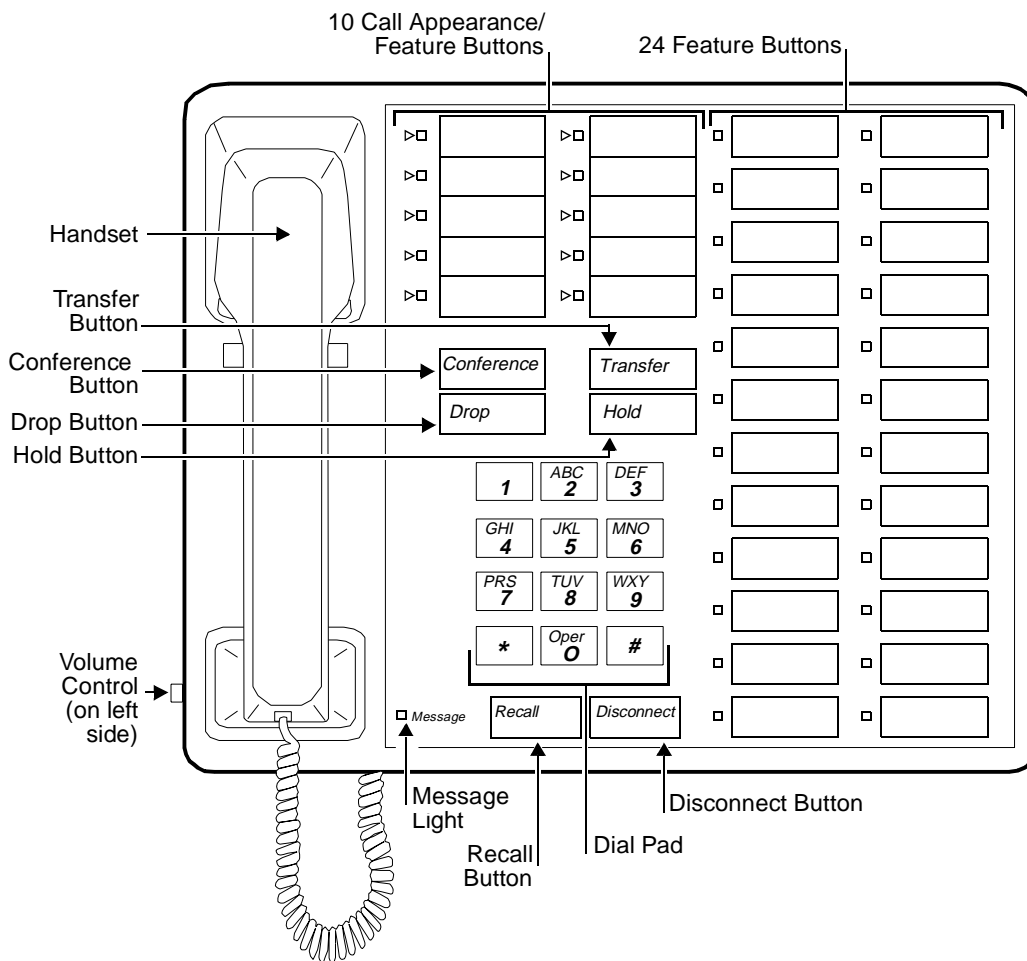

Figure 9-2. The 7205H Voice Terminal

The 7205H is a multi-appearance hybrid voice terminal which provides six buttons for fixed features, 10 buttons for line appearances or one-touch feature activation, and 24 feature-only buttons. It requires 3-pair wiring for operation. One wire pair is used for analog voice, while the other two pairs are used for digital control and signaling.



**NOTE:**

The 7205H voice terminal was discontinued in March 1988.

## Applications

---

The 7205H voice terminal can be used with System 85 and the DEFINITY Communications System Generic 2. However, on a DEFINITY G2, this voice terminal can only be used on a traditional module and the SN224 circuit pack. This voice terminal is suitable for managers, executive secretaries, office support personnel, and others who do not need data capabilities.

## Physical Description

---

### Dimensions



**NOTE:**

The following dimensions are approximate.

Width = 10-1/4 inches

Depth (front to back) = 8-3/4 inches

Height (maximum with handset in place) = 5-1/2 inches

Thickness of housing = 1-1/2 inches

### Features

#### Six Fixed Feature Buttons

- RECALL button
- DISCONNECT button
- CONFERENCE button
- DROP button
- TRANSFER button
- HOLD button

#### Message Light

The green Message light goes on when a message is left for the user. It goes off when the user retrieves the message.

#### Call Appearance/Feature Buttons

The 7205H voice terminal has 10 call appearance/feature buttons. Adjacent to each button is a pair of red and green indicator lights.



## **Feature-Only Buttons**

The 7205H voice terminal has 24 feature-only buttons.

## **Other Physical Features**

### **Handset**

The 7205H voice terminal is equipped with an R-type handset.

### **Dial pad**

The 7205H voice terminal has a 12-button touch-tone dial pad.

### **Jacks**

The 7205H voice terminal housing contains three jacks. The handset cord jack is just under the left side of the housing. (The handset contains a jack for the other end of the handset cord.) The line jack is on the bottom center of the housing. The modular speakerphone/handset jack is located on the bottom of the set.

### **Cords**

Two cords are supplied with the 7205H voice terminal: a coiled 7-foot modular handset cord and a 7-foot modular line cord. Optional longer cords are available: a 12-foot handset cord, and 14-foot and 25-foot line cords.

### **Ringling**

The 7205H voice terminal has electronic tone ringling. The volume control is on the left side of the housing.

### **Mounting Options**

The 7205H voice terminal comes equipped with a nonadjustable desk stand. An optional wall mounting kit can be ordered.

### **Color Options**

The 7205H voice terminal was available in various colors; however, maintenance replacements will be black only.

## Distance Limitations

---

The maximum allowable distances of a 7205H voice terminal from the System 85 and the DEFINITY G2 cabinet are shown in the following table.

**Table 9-2. Distance Limitations for the 7205H Voice Terminal**

System	Port Board	Number of Adjuncts	Nominal Maximum Range in Feet (Meters)	
			24 AWG	26 AWG
DEFINITY G2 and System 85	SN224	0	3,000 (915)	2,300 (700)
		1	1,750 (533)	1,100 (335)
		2	1,000 (305)	750 (288)

## Power Requirements

---

The 7205H voice terminal is powered by the tip and ring leads. If the 7205H is equipped with the S101A speakerphone or the 500A headset adapter, auxiliary power will be required for the adjunct. Refer to the **Adjunct Power** section earlier in this manual.

The C201A call coverage module attaches to the top of the voice terminal, and the F201A function key module attaches to the right side. These optional modules use the same phantom power from the switch (through the digital pairs) that also powers the 7205H voice terminal. This impacts the distance allowed from the switch.

## Power Failure Operation

---

The 7205H voice terminal cannot be used as an emergency station during power failure transfer conditions.

## FCC Registration

---

The 7205H voice terminal is not FCC registered.

## Hearing Aid Compatible

---

The 7205H voice terminal is compatible with the inductively coupled hearing aids prescribed by the FCC.

## 7205H Equipment PECs

The 7205H voice terminal and optional components were ordered with the following PECs:

- Basic 7205H Voice Terminal — 3183-40H/CLR
- Handset cord (12 feet) — 2725-01L COL09
- Line cord (14 feet, silver) — 2725-07N COL18
- Line cord (25 feet, silver) — 2725-07S COL18

## Adjuncts

The following adjuncts can be used with this voice terminal:

- S101A Speakerphone or 500A Headset Adapter and a standard headset
- C201A Call Coverage Module
- F201A Function Key Module
- S201A Speakerphone

## Additional Documents

The following documents contain additional information relating to the 7205H voice terminal:

- *System 85 7205H Voice Terminal User's Guide, 555-102-709*
- *DEFINITY Generic 1 and Generic 2, System 75, and System 85 Terminals and Adjuncts Installation and Test, 555-015-104*

**9** The 7200 Series Voice Terminals  
*The 7205H Voice Terminal*

9-12

## The 7300 Series Voice Terminals

# 10

---

This section describes the following 7300 Series voice terminals:

- 7303S voice terminal
- 7305S voice terminal

## The 7303S Voice Terminal

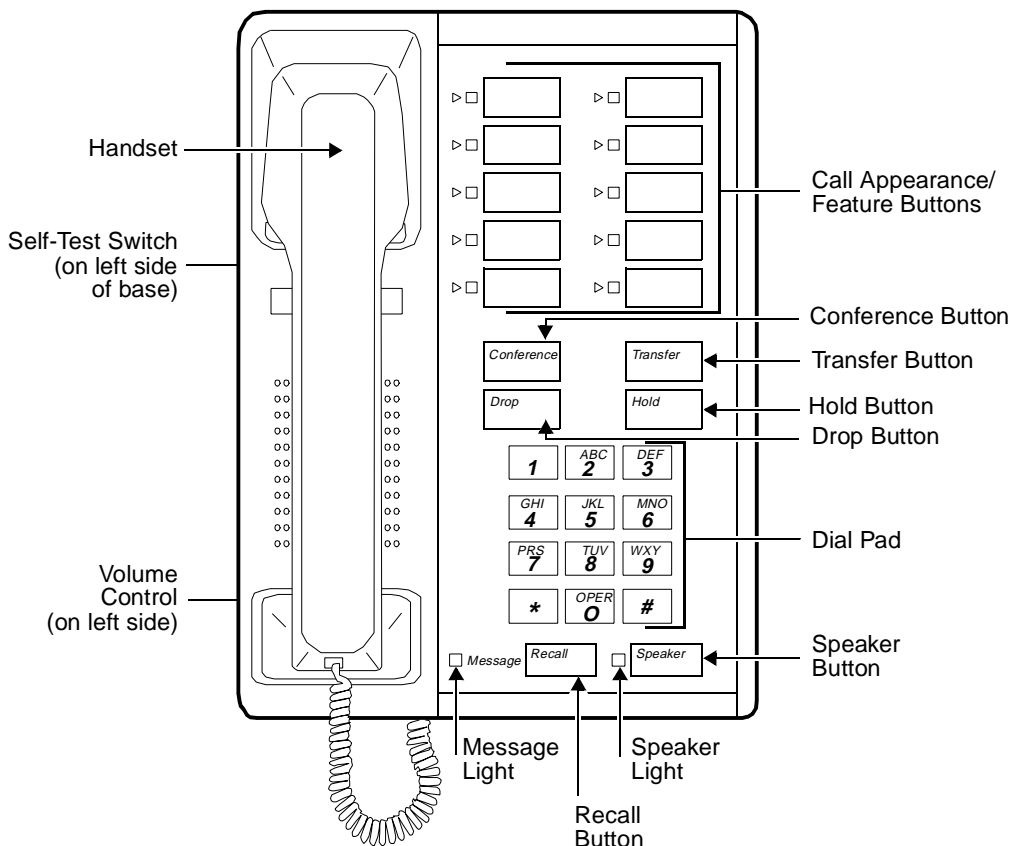

Figure 10-1. The 7303S Voice Terminal

The 7303S is a multi-appearance hybrid voice terminal which provides access to 10 line appearances or selected programmable features. The 7303S voice terminal is also equipped with six fixed feature buttons. It requires 3-pair wiring for operation. One wire pair is used for analog voice, while the other two pairs are used for digital control and signaling.



**NOTE:**

The 7303S voice terminal was discontinued in July 1990.

## **Applications**

---

The 7303S voice terminal can be used with the DEFINITY Communications System Generic 1, Generic 2, and Generic 3, the DEFINITY ECS, System 75 and System 85 (R2 only). This voice terminal is suitable for managers, executive secretaries, office support personnel, and others who do not need data capabilities.

## **Physical Description**

---

### **Dimensions**



**NOTE:**

The following dimensions are approximate.

Width = 7 inches

Depth (front to back) = 8-3/4 inches

Height (maximum with handset in place) = 5-1/2 inches

Thickness of housing = 1-1/2 inches

### **Features**

#### **Six Fixed Feature Buttons**

- RECALL button
- SPEAKER button
- CONFERENCE button
- DROP button
- TRANSFER button
- HOLD button

#### **Message Light**

The green Message light goes on when a message is left for the user. It goes off when the user retrieves the message.

#### **Call Appearance/Feature Buttons**

The 7303S voice terminal has 10 call appearance/feature buttons. Adjacent to each button is a pair of red and green indicator lights.

### **Self Test**

The 7303S voice terminal is equipped with a self-test for its buttons and tone ringer. The self-test switch is located on the left side of the base.

### **Loudspeaker**

The 7303S voice terminal has a built-in listen only loudspeaker. The volume control for the speaker is the same control used for the tone ringer volume. It is located on the left side of the housing.

## **Other Physical Features**

### **Handset**

The 7303S voice terminal is equipped with an R-type handset.

### **Dial pad**

The 7303S voice terminal has a 12-button touch-tone dial pad.

### **Jacks**

The 7303S voice terminal housing contains three jacks. The handset cord jack is just under the left side of the housing. (The handset contains a jack for the other end of the handset cord.) The line jack is on the bottom center of the housing. The modular speakerphone/handset jack is located on the bottom of the set.

### **Cords**

Two cords are supplied with the 7303S voice terminal: a coiled 7-foot modular handset cord and a 7-foot modular line cord. Optional longer cords are available: a 12-foot handset cord, and 14-foot and 25-foot line cords.

### **Ringling**

The 7303S voice terminal has electronic tone ringling. The volume control is on the left side of the housing.

### **Mounting Options**

The 7303S voice terminal comes equipped with a nonadjustable desk stand. An optional wall mounting kit can be ordered.

### **Color Options**

The 7303S Voice Terminal was available in various colors; however, maintenance replacements are black or misty cream only.



## Distance Limitations

The maximum allowable distances of a 7303S voice terminal from the DEFINITY G1, G2, and G3, DEFINITY ECS, System 75, or System 85 cabinet are shown in the table below.

**Table 10-1. Distance Limitations for the 7303S Voice Terminal**

System	Port Board	Number of Adjuncts	Nominal Maximum Range in Feet (Meters) (See Note)	
			24 AWG	26 AWG
System 85	ANN17B	0	1,700 (519)	1,000 (305)
		1	1,000 (305)	650 (198)
DEFINITY G2	ANN17B	0	1,700 (519)	1,000 (305)
		1	1,000 (305)	650 (198)
	TN762B	–	1,000 (305)	750 (229)
DEFINITY G1 and G3, DEFINITY ECS, and System 75	TN762	–	1,000 (305)	750 (229)

**Note:**

Range may be extended to 2,000 feet (610m) for 24- or 26-AWG wire by adding local -48 volt DC power in the satellite closet. Power supplies such as the 346A or 329A may be connected to the fourth pair from the terminals to obtain the increased range. These power supplies must be within 250 feet of the terminals.

## Power Requirements

The 7303S voice terminal is powered by the tip and ring leads. If the 7303S is equipped with an adjunct, it is powered by the same power source. This impacts the maximum nominal cabling distance. The range may be extended by adding a -48 volt DC power source in the satellite closet.

## Power Failure Operation

The 7303S voice terminal cannot be used as an emergency station during power failure transfer conditions.

## FCC Registration

The 7303S voice terminal is not FCC registered.

## **Hearing Aid Compatible**

---

The 7303S voice terminal is compatible with the inductively coupled hearing aids prescribed by the FCC.

## **7303S Equipment PECs**

---

The 7303S voice terminal and optional components were ordered with the following PECs:

- Basic 7303S Voice Terminal — 3176-16S/CLR
- Handset cord (12 feet — 2725-01L COL09
- Line cord (14 feet, silver) — 2725-07N COL18
- Line cord (25 feet, silver) — 2725-07S COL18

## **Adjuncts**

---

One of the following adjuncts can be used with this voice terminal:

- S102A Speakerphone
- S202A Speakerphone
- 502A Headset Adapter and a standard headset

## **Additional Documents**

---

The following documents contain additional information relating to the 7303S voice terminal:

- *DEFINITY Generic 2, System 85 7303S Voice Terminal User's Guide, 555-103-707*
- *DEFINITY Generic 1, System 75 7303S Voice Terminal User's Guide, 555-200-706*
- *DEFINITY Generic 1 and Generic 2, System 75, and System 85 Terminals and Adjuncts Installation and Test, 555-015-104*

## The 7305S Voice Terminal

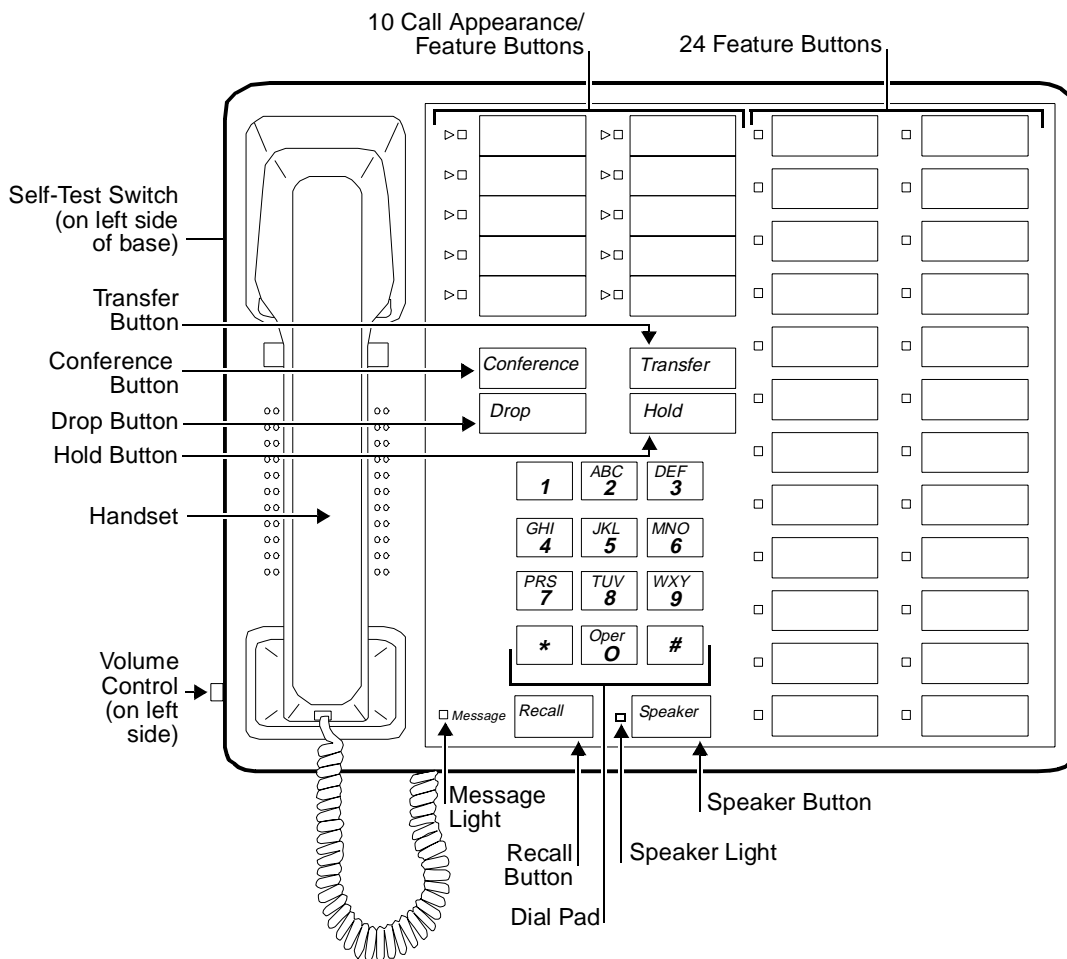

Figure 10-2. The 7305S Voice Terminal

The 7305S voice terminal is a multi-appearance hybrid voice terminal which provides access to 10 line appearances. The 10 line appearance buttons can also be used as programmable feature buttons. The 7305S voice terminal is also equipped with 24 programmable feature buttons and six fixed feature buttons. It requires 3-pair wiring for operation. One wire pair is used for analog voice, while the other two pairs are used for digital control and signaling.



**NOTE:**

The 7305S voice terminal was discontinued in July 1990.

## Applications

---

The 7305S voice terminal can be used with the DEFINITY Communications System Generic 1, Generic 2, and Generic 3, the DEFINITY ECS, System 75, and System 85 (R2V2 or higher). This voice terminal is suitable for managers, executive secretaries, office support personnel, sales support people, and others who do not need data capabilities.

## Physical Description

---

### Dimensions



**NOTE:**

The following dimensions are approximate.

Width = 10-1/4 inches

Depth (front to back) = 8-3/4 inches

Height (maximum with handset in place) = 6-1/4 inches

Thickness of housing = 1-1/2 inches

### Features

#### Six Fixed Feature Buttons

- RECALL button
- SPEAKER button
- CONFERENCE button
- DROP button
- TRANSFER button
- HOLD button

#### Message Light

The green Message light goes on when a message is left for the user. It goes off when the user retrieves the message.

#### Call Appearance/Feature Buttons

The 7305S voice terminal has 10 call appearance/feature buttons. Adjacent to each button is pair of red and green indicator lights.

### **Feature-Only Buttons**

The 7305S voice terminal has 24 feature-only buttons. Adjacent to each button is a green (status) indicator light.

### **Self-Test**

The 7305S voice terminal is equipped with a self-test for its buttons and tone ringer. The self-test switch is located on the left side of the base.

### **Loudspeaker**

The 7305S voice terminal has a built-in listen only loudspeaker. The volume control for the speaker is the same control used for the tone ringer volume. It is located on the left side of the housing.

## **Other Physical Features**

### **Handset**

The 7305S voice terminal is equipped with an R-type handset.

### **Dial pad**

The 7305S voice terminal has a 12-button touch-tone dial pad.

### **Jacks**

The 7305S voice terminal housing contains three jacks. The handset cord jack is just under the left side of the housing. (The handset contains a jack for the other end of the handset cord.) The line jack is on the bottom center of the housing. The modular speakerphone/handset jack is located on the bottom of the set.

### **Cords**

Two cords are supplied with the 7305S voice terminal: a coiled 7-foot modular handset cord and a 7-foot modular line cord. Optional longer cords are available: a 12-foot handset cord, and 14-foot and 25-foot line cords.

### **Ringling**

The 7305S voice terminal has electronic tone ringling. The volume control is on the left side of the housing.

### **Mounting Options**

The 7305S voice terminal comes equipped with a adjustable desk stand. An optional wall-mounting kit can be ordered.

### **Color Options**

The 7305S voice terminal was available in black and misty cream.

## Distance Limitations

The maximum allowable distances of a 7303S from the DEFINITY G1, G2, and G3, the DEFINITY Enterprise Communications System (ECS), System 75, or System 85 cabinet are shown in the table below.

**Table 10-2. Distance Limitations for the 7305S Voice Terminal**

System	Port Board	Number of Adjuncts	Nominal Maximum Range in Feet (Meters) (See Note)	
			24 AWG	26 AWG
System 85	ANN17B	0	1,000 (305)	650 (198)
		1	700 (213)	450 (137)
DEFINITY G2	ANN17B	0	1,000 (305)	650 (198)
		1	700 (213)	450 (137)
	TN762B	–	1,000 (305)	750 (229)
DEFINITY G1 and G3, DEFINITY ECS, and System 85	TN762	–	1,000 (305)	750 (229)

**NOTE:**

Range may be extended to 2,000 feet (610m) for 24- or 26-AWG wire by adding local -48 volt DC power in the satellite closet. Power supplies such as the 346A or 329A may be connected to the fourth pair from the terminals to obtain the increased range. These power supplies must be within 250 feet of the terminals.

## Power Requirements

The 7305S voice terminal is powered by the tip and ring leads. If the 7305S voice terminal is equipped with the S202A or S102A speakerphone or the 500A headset adapter, auxiliary power will be required for the adjunct. Refer to the **Adjunct Power** section earlier in this manual.

## Power Failure Operation

The 7305S voice terminal cannot be used as an emergency station during power failure transfer conditions.

## FCC Registration

The 7305S voice terminal is not FCC registered.

## **Hearing Aid Compatible**

---

The 7305S voice terminal is compatible with the inductively coupled hearing aids prescribed by the FCC.

## **7305S Equipment PECs**

---

The 7305S voice terminal and optional components were ordered with the following PECs:

- Basic 7305S Voice Terminal (black) — 3177-40SA/CLR
- Handset cord (12 feet) — 2725-01L COL09
- Line cord (14 feet, silver) — 2725-07N COL18
- Line cord (25 feet, silver) — 2725-07S COL18

## **Adjuncts**

---

One of the following adjuncts can be used with this voice terminal:

- S102A Speakerphone
- 502A Headset Adapter and a standard headset
- S202A Speakerphone

## **Additional Documents**

---

The following documents contain additional information relating to the 7305S voice terminal:

- *System 85 7305S Voice Terminal User's Guide, 555-103-707*
- *System 75 7305S Voice Terminal User's Guide, 555-200-706*
- *DEFINITY Generic 1 and Generic 2, System 75, and System 85 Terminals and Adjuncts Installation and Test, 555-015-104*

**10** The 7300 Series Voice Terminals  
*The 7305S Voice Terminal*

10-12



## The 7400 Series Voice Terminals

# 11

---

The following 7400 Series voice terminals are described in this section:

- 7401D and 7401 Plus voice terminals
- 7402 Plus voice terminal
- 7403D voice terminal
- 7404D voice terminal
- 7405D voice terminal
- 7406D, 7406BIS, and 7406 Plus voice terminals
- 7407D, Enhanced 7407D, and 7407 Plus voice terminals
- 7410D and 7410 Plus voice terminals
- 7434D voice terminal
- 7444 voice terminal

# The 7401D and 7401 Plus Voice Terminals

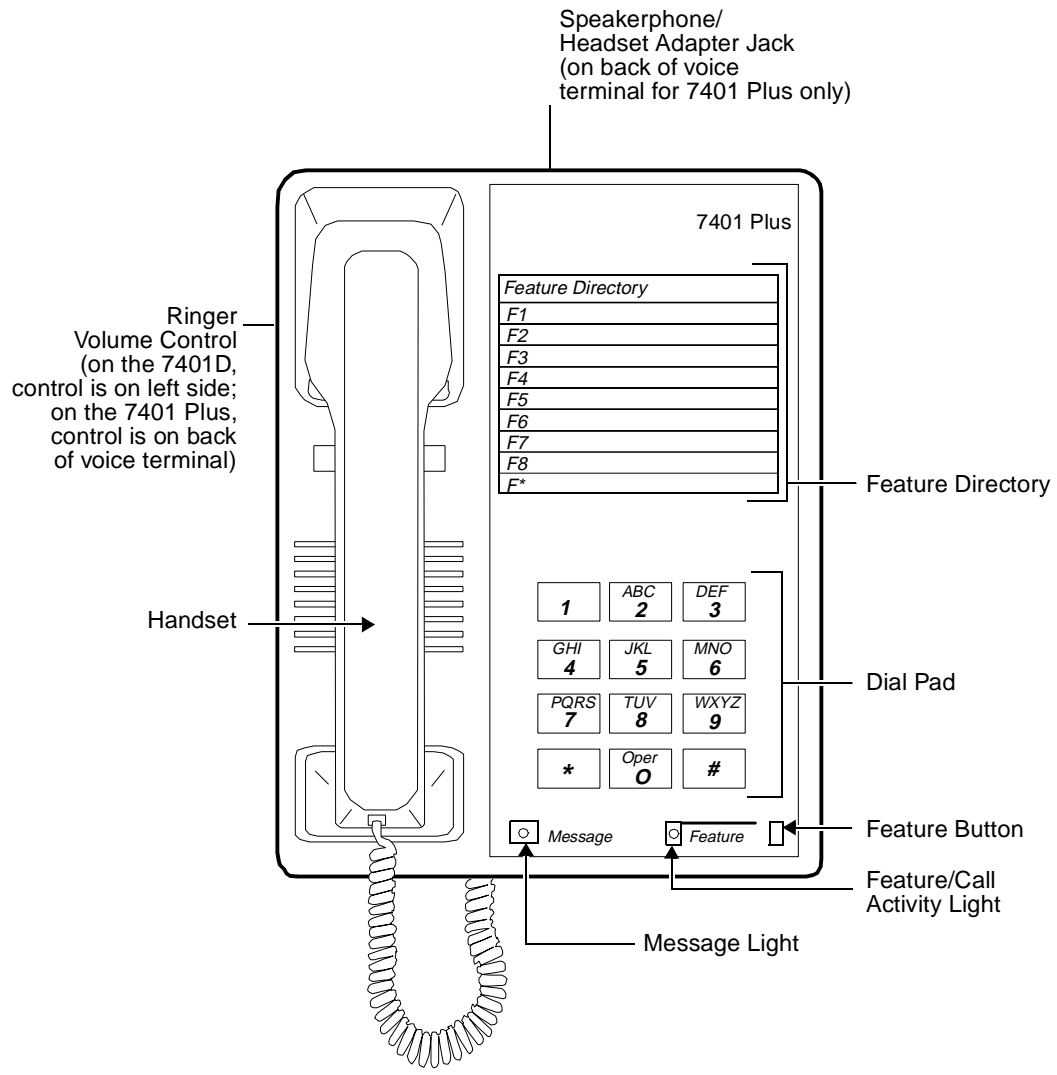

Figure 11-1. The 7401 Plus (7401D02A) Voice Terminal

**11** The 7400 Series Voice Terminals  
The 7401D and 7401 Plus Voice Terminals

11-3

The 7401D (7401D01A) and the 7401 Plus (7401D02A, the newest 7401 set) are both single appearance digital voice terminals which have no call appearance buttons or lights, but have two virtual call appearances (refer to the section below titled **Special Operational Characteristics**). The user answers a call by going off-hook. The second appearance is primarily used with the Conference and Transfer features. However, it can be used to originate an outgoing call or receive a second incoming call. Depending on how the 7401D or the 7401 Plus voice terminal is administered, the second call appearance may be restricted to incoming priority calls and outgoing calls only.

 **NOTE:**

The 7401D01A is no longer being manufactured. The 7401D02A (7401 Plus) was discontinued January, 1995.

## Applications

The 7401D (7401D01A) and the 7401 Plus (7401D02A) voice terminals can be used with the DEFINITY Communications System Generic 1, Generic 2, and Generic 3, the DEFINITY ECS, System 75, and System 85. These voice terminals are especially suitable for general office workers with low call volumes, manufacturing, warehousing, guard and/or reception areas, or office desks.

The 7401D and 7401 Plus voice terminals can also provide simultaneous voice and data communications with the 7400B Data Module. PC platform products can also be useful in providing voice capabilities since these screen-based products can greatly enhance the telephone capabilities of these basic voice terminals.

## Special Operational Characteristics

The 7401D (7401D01A) and 7401 Plus (7401D02A) do not have traditional call appearance buttons with indicators. To the user, these voice terminals appear to be single call appearance sets. However, there are two *virtual* call appearances with *virtual* in-use and *virtual* status indicators. That is, to the PBX, the 7401D and 7401 Plus voice terminals appear to be a two call appearance set. These call appearances are necessary to provide the Conference, Transfer, and Hold features.

The Automatic Line Management (ALM) feature of the 7401D or 7401 Plus voice terminal automatically selects one of the two *virtual* call appearances when the user goes off-hook either by the user's lifting the handset (on the 7401D or the 7401 Plus voice terminal) or turning on the optional speakerphone adjunct (on the 7401 Plus voice terminal). ALM follows a hierarchical algorithm. From the user's point of view, the hierarchical order of actions which could take place is:

1. If either of the status lights of the virtual call appearances is flashing when the user takes the telephone off-hook, the voice terminal will always pick-up the "ringing" call. If both virtual call appearances are in the flashing state, the voice terminal will select the call that was ringing for the longer period of time.
2. If neither of the status lights is flashing, but one is winking or fluttering when the telephone goes off-hook, the voice terminal will automatically "un-hold" the held call. If both virtual call appearances are in the held state, the voice terminal will select the call that was on hold for the longer period of time.
3. If neither of the status lights is flashing, winking, or fluttering, but one is steady when the voice terminal goes off-hook, the voice terminal will automatically bridge on to the busy appearance. If both virtual call appearances are in the steady state, the voice terminal will choose the first virtual call appearance. (A call appearance can be in the busy state due to another party answering the call. This can occur in conjunction with such features as coverage, bridging or pickup.)
4. Otherwise, no special action is taken; the voice terminal will pick up an idle virtual call appearance as determined by the PBX.

## Physical Features

---

### Dimensions



**NOTE:**

The dimensions described here for the 7401D and 7401 Plus voice terminals are approximate.

Width = 6-3/8 inches

Depth (front to back) = 8-3/4 inches

Height (maximum with handset in place) = 5-1/2 inches

Thickness of housing = 1-1/2 inches

## Features

### The Feature Button

The FEATURE button allows the dial pad to serve as 12 feature buttons without indicators:

- Four standard fixed feature buttons: Conference, Transfer, Drop, Hold
- The Select Ring feature
- Seven administrable feature buttons used with the FEATURE button

### Feature/Call Activity Light

The green Feature/Call Activity light goes on steadily when the user presses the FEATURE button. This light flutters when there is an incoming call, when a call is put on hold, or when a call has been answered by another bridged extension. It flutters intermittently when Select Ring is used.

### Feature Directory

The 7401D (7401D01A) voice terminal has a reversible feature directory card. One side lists fixed features and leaves spaces for features assigned by the system manager; the other side lists fixed and recommended features.

The 7401 Plus (7401D02A) voice terminal has a one-sided feature directory card. The directory lists fixed features and has spaces for features assigned by the system manager.

### Message Light

The Message light goes on when a message is left for the user. It goes off when the user retrieves the message. On the 7401D voice terminal, the Message light is green; on the 7401 Plus voice terminal, the Message light is red.

## Other Physical Features

### Handset

The 7401D and 7401 Plus voice terminals are equipped with an R-type handset.

### Dial pad

The 7401D and the 7401 Plus voice terminals are equipped with a 12-button touch-tone dial pad. On the 7401 Plus voice terminal, the letters "Q" and "Z" have been added to the appropriate dial pad keys for directory access, and the "5" button on the dial pad has raised bars for visually-impaired users.

## **Jacks**

The 7401D and 7401 Plus voice terminals' housing has a Handset cord jack. (On the 7401D voice terminal, this jack is located just under the center front edge of the housing; on the 7401 Plus the Handset cord jack is located on the back of the housing near the front/center.) Both voice terminals have a Line jack located on the back of the housing.

The 7401 Plus (7401D02A) voice terminal also has a Speakerphone/headset adapter jack to which the user can connect adjunct equipment.

## **Cords**

Two cords are supplied with the 7401D (7401D01A) and the 7401 Plus (7401D02A) voice terminal: a coiled 9-foot handset cord and a 7-foot line cord.

Optional longer cords are available: a 12-foot handset cord, and 14-foot and 25-foot line cords.

## **Ringling**

The 7401D and 7401 Plus voice terminals have electronic tone ringling. With the Select Ring feature, the user can choose any one of eight different ringling patterns.

The 7401D (7401D01A) voice terminal has a volume control on the left side of the housing.

The 7401 Plus (7401D02A) voice terminal has a volume control for the tone ringer on the back of the voice terminal, along the left edge.

## **Mounting Options**

The 7401D and 7401 Plus voice terminals come equipped with both a nonadjustable desk stand and a wall mounting bracket.

## **Color Options**

The 7401D and 7401 Plus voice terminals are available in black and misty cream.

## Distance Limitations

The maximum allowable distances of a 7401D or a 7401 Plus voice terminal from the DEFINITY ECS G1, G2, and G3, DEFINITY ECS, System 75, or System 85 cabinet are shown in the following table.

**Table 11-1. Distance Limitations for the 7401D and 7401 Plus Voice Terminals**

System	Port Board	Nominal Maximum Range in Feet (Meters) (See Note)	
		24 AWG	26 AWG
System 85	SN270B	3,400 (1,034)	2,200 (671)
	TN754	3,400 (1,034)	2,200 (671)
DEFINITY G2	SN270B	3,400 (1,034)	2,200 (671)
	TN754	3,400 (1,034)	2,200 (671)
DEFINITY G1 and G3, DEFINITY ECS, and System 75	TN754	3,400 (1,034)	2,200 (671)

**Note:**

These ranges can be extended to 5,000 feet (1524 m) for 24 AWG wire and 4,000 feet (1219 m) for 26 AWG wire with the use of a Data Link Protector. Refer to the **Exposed Port Protection** section earlier in this manual.

## Power Requirements

The 7401D and 7401 Plus voice terminals receive power from the system and do not require any external power supply. Additional external power is required when the 7401 Plus voice terminal is equipped with any adjuncts, such as an external speakerphone. Refer to the **Adjunct Power** section earlier in this manual.

## **Switch Administration**

---

### **Aliasing**

The 7401 voice terminals must be aliased in the following way:

**Table 11-2. Administering the 7401D and 7401 Plus Voice Terminals**

<b>If this type of voice terminal:</b>	<b>Is connected to this system:</b>	<b>The voice terminal must be administered as:</b>
7401D 7401 Plus	System 75, R1V1, V2, V3 System 85, R2V1, V2, V3	a 7403D voice terminal
7401D	DEFINITY G1 and G3, and DEFINITY ECS  System 85, R2V4 or above  DEFINITY G2	itself
7401 Plus	DEFINITY G1 and G3, and DEFINITY ECS  System 85, R2V4 or above  DEFINITY G2	a 7401D voice terminal



## Button Numbering

The 7401 Plus (7401D02A) voice terminal can be administered in the same manner as the 7401D (7401D01A) voice terminal. Both types of voice terminals have 12 possible voice features; however, only seven of these features can be administered on the voice terminal (F1 through F7 on the Feature Directory). The remaining five features are fixed (F8, F9, F0, F#, and F\* on the Feature Directory):

- F8 Conference
- F9 Transfer
- F0 Drop
- F# Hold
- F\* Select Ring

The following button diagrams of the 7401D and 7401 Plus voice terminals will help you administer both of these voice terminals connected to a System 75, a DEFINITY G1 and G3, or a DEFINITY ECS, and to a System 85 or a DEFINITY G2.

Figures 11-2 and 11-3 show button numbering for both the 7401D and the 7401 Plus voice terminals.

### NOTE:

Although these figures show the 7401 Plus set, the administration of the two types of voice terminals is the same.

If you need more information, refer to *DEFINITY Communications System Generic 3 Implementation*, 555-230-653, and *DEFINITY Communications System Generic 2 Administration of Features and Hardware*, 555-104-507.

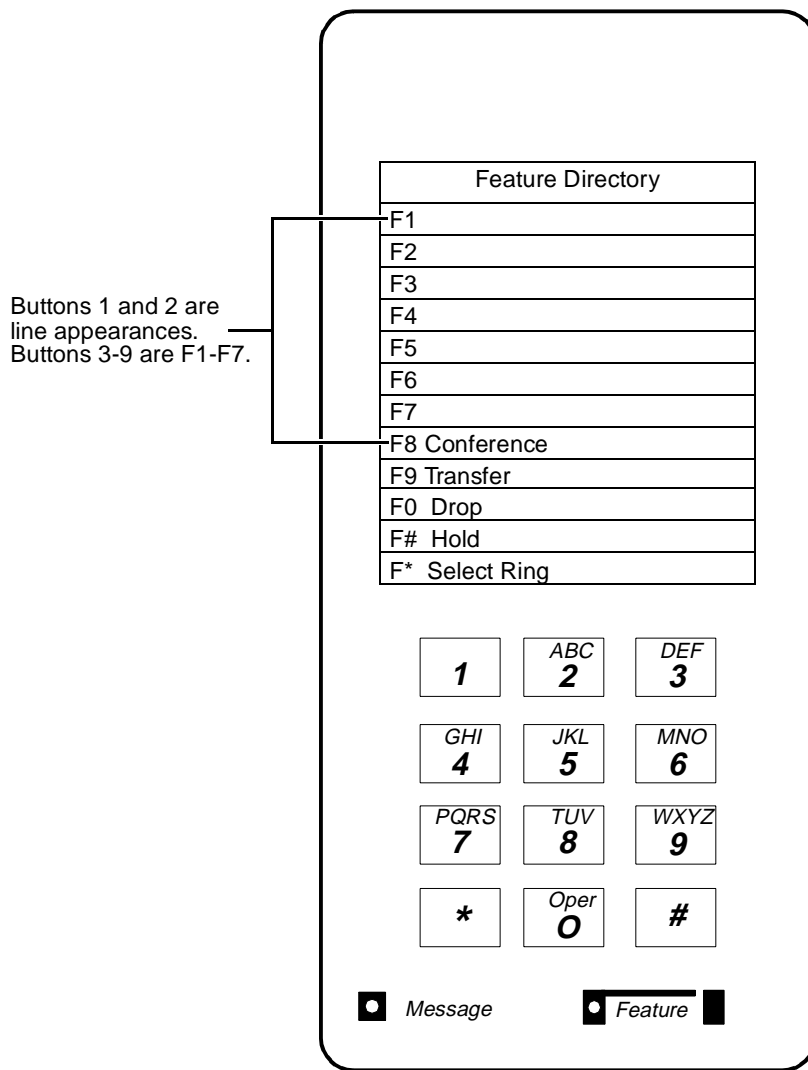

Figure 11-2. Button Number for Administering the 7401D and 7401 Plus Voice Terminals Connected to a System 75, DEFINITY G1 and G3, or a DEFINITY ECS

Buttons 1 and 2 are the Hold Button and the Message Light. Buttons 3 and 4 are line appearances. Buttons 5-11 are F1 through F7.

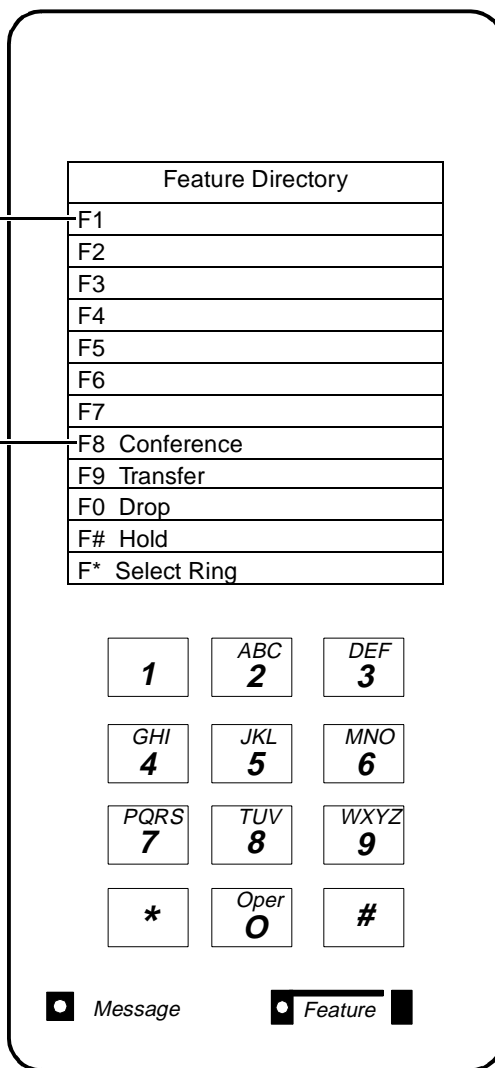

Figure 11-3. Button Numbering for Administering the 7401D and 7401 Plus Voice Terminals Connected to a System 85 or a DEFINITY G2

### Power Failure Operation

The 7401D and 7401 Plus voice terminals cannot be used as an emergency station during power failure transfer conditions.

11 The 7400 Series Voice Terminals  
*The 7401D and 7401 Plus Voice Terminals*

11-12

## FCC Registration

These voice terminals are FCC-registered along with the switch (as a system), but do not have a separate FCC registration label.

## UL and CSA Approval

These voice terminals have been tested and have met the Underwriters Laboratories (UL) Standards UL 1459 and have also met the Canadian Standards Association (CSA) Standards CSA-C22.2 No.225-M90.

## Hearing Aid Compatible

These voice terminals are compatible with the inductively coupled hearing aids prescribed by the FCC.

## 7401D Equipment PECs and Comcodes

The 7401D (7401D01A) voice terminals and components can be ordered with these Price Element Codes (PECs) and Comcodes:

- **Basic 7401D Voice Terminal**  
PEC: 3184-CDT (Black=COL09; Misty Cream=COL22)  
Comcode: Black=105353056; Misty Cream=105269153
- **Handset**  
Comcode: Black=105157291; Misty Cream=105158885
- **Handset cord (9 feet)**  
Comcode: Black=105635429; Misty Cream=105635437
- **Handset cord (12 feet)**  
PEC: 2725-01L (Black=COL09; Misty Cream=COL22)  
Comcode: Black=102401445; Misty Cream=104211339
- **Line cord (7 feet, silver)**  
Comcode: 105304646
- **Line cord (14 feet, silver)**  
PEC: 2725-07N (COL18)  
Comcode: 103786802
- **Line cord (25 feet, silver)**  
PEC: 2725-07S (COL18)  
Comcode: 103786828
- **Faceplate and tab**  
Comcode: Black=846209161; Misty Cream=846209179

11 The 7400 Series Voice Terminals

*The 7401D and 7401 Plus Voice Terminals*

11-13

- **Button designation cards**  
(Package of 50)  
PEC: 31841 (Black=COL09; Misty Cream=COL22)  
Comcode: Black=846051225; Misty Cream=846051183
- **Desk stand/Wall mount assembly**  
Comcode: 846028546

## 7401 Plus Equipment with PECs and Comcodes

The following 7401 Plus (7401D02A) voice terminal and components can be ordered with the following PECs and Comcodes:

- **Basic 7401 Plus Voice Terminal**  
PEC: 3184-PLS (Black=COL18; Misty Cream=COL22)  
Comcode: Black=106224454; Misty Cream=106224462
- **Handset**  
Comcode: Black=105519086; Misty Cream=105520787
- **Handset cord (9 feet)**  
Comcode: Black=105635429; Misty Cream=105635437
- **Handset cord (12 feet)**  
PEC: 2725-01L (Black=COL09; Misty Cream=COL22)  
Comcode: Black=102401445; Misty Cream=104211339
- **Line cord (7 feet)**  
Comcode: 103786778
- **Line cord (14 feet, silver)**  
PEC: 2725-07N (COL18)  
Comcode: 103786828
- **Line cord (25 feet, silver)**  
PEC: 2725-07S (COL18)  
Comcode: 103786802
- **Faceplate**  
(Package of 50)  
PEC: 31846  
Comcode: Black=846551141 Misty Cream=846551406
- **Button designation card**  
PEC: 31844 (Package of 50 cards)  
Single Sheets, Comcode: 846521656  
Pack of 50, Comcode: 846521664  
Tractor Feed, 200 Sheets, Comcode: 846551672  
Tractor Feed, 500 Sheets, Comcode: 846551680
- **Desk stand/Wall mount assembly**  
Comcode: 846028546

## Adjuncts

---

One of the following adjuncts can be used with the 7401D (7401D01A) voice terminal:

- R6 Amplifier Handset (PEC: 3152-002)
- R8 Noisy Location Handset (PEC: 3152-003)
- 7400B Data Module

The following adjuncts can be used with the 7401 Plus (7401D02A) voice terminal:

- S101A Speakerphone (no longer orderable)
- S201A Speakerphone
- CS201A Speakerphone
- 7400B Data Module
- 500A Headset Adapter (and a standard headset; see “Headsets” below)
- R6 Amplifier Handset (PEC: 3152-002)
- R8 Noisy Location Handset (PEC: 3152-003)
- R2H Standard Handset (PEC: 3152-006)
- Shoulder Rest

## Headsets

A list of compatible headsets, consisting of both modular and plug prong base units and selection of headpieces, appears in “Headset Adapters” in the **Adjuncts** section later in this manual.

## **Additional Documents**

---

The following documents contain additional information relating to the 7401D and 7401 Plus voice terminals: (Use the 9 digit number listed after each document to order the book from the BCS Publications Center for Lucent Technologies.)

- *7401D Voice Terminal Installation Instructions, 555-015-106*
- *System 75 7401D Voice Terminal User's Guide, 555-200-727*
- *DEFINITY Communications System Generic 1 7401D Voice Terminal User's Guide, 555-204-727*
- *DEFINITY Communications System Generic 2 and System 85 7401D Voice Terminal User's Guide, 555-104-712*
- *DEFINITY Communications System Generic 1 and System 75 7401 Plus Voice Terminal User's Guide, 555-204-740*
- *DEFINITY Communications System Generic 2 and System 85 7401 Plus Voice Terminal User's Guide, 555-104-740*

The following document is shipped with every 7401 Plus voice terminal:

- *7401 Plus and 7410 Plus Voice Terminals Installation Instructions*

## The 7402 Plus Voice Terminal

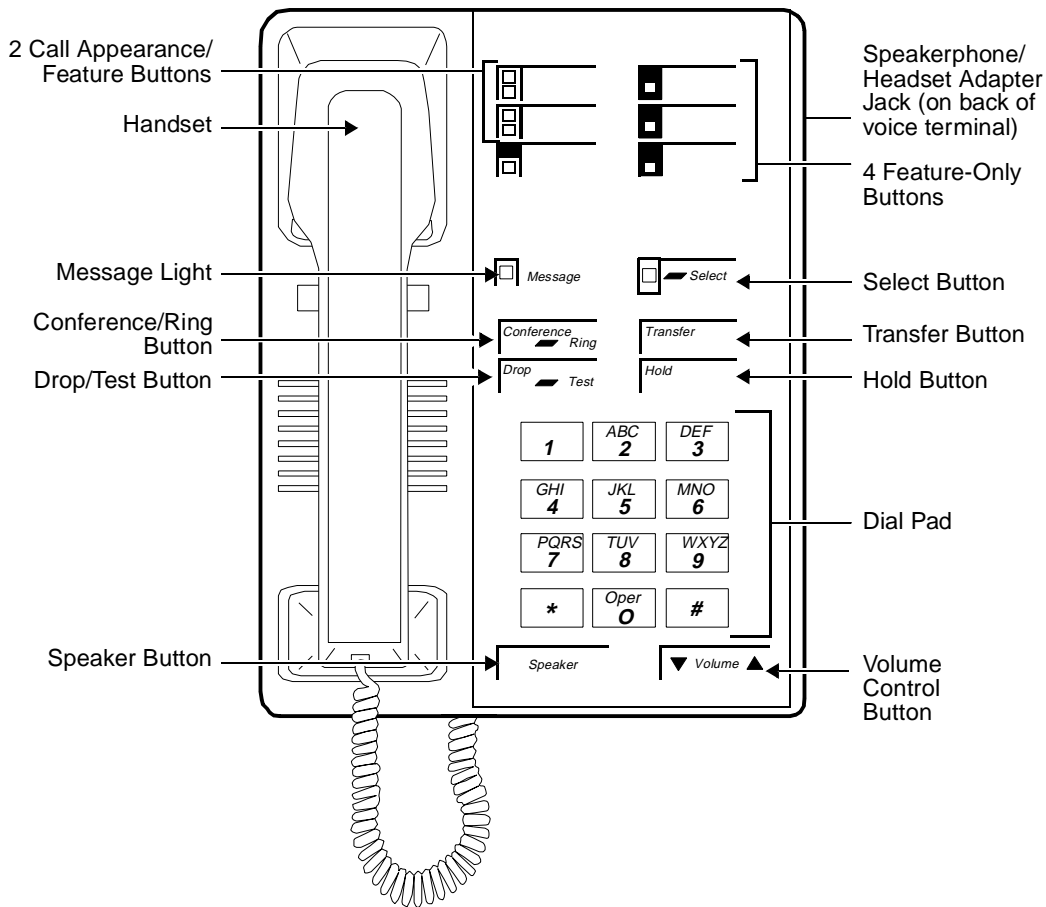

Figure 11-4. The 7402 Plus Voice Terminal



11 The 7400 Series Voice Terminals  
The 7402 Plus Voice Terminal

11-17

The 7402 Plus is a multi-appearance digital voice terminal with two line appearances, four variable feature buttons, four standard fixed feature buttons (CONFERENCE, DROP, TRANSFER, and HOLD), a SELECT button, a Message light, a SPEAKER button for accessing a listen-only speaker, a Ringer Volume control, and a Speakerphone/headset adapter jack on the back of the voice terminal for connecting adjunct equipment. By pressing the SELECT button and then the CONFERENCE/RING button, the user can choose among eight possible programmable ringing patterns. A Self-Test feature can also be activated to test the lights and tone ringer on the voice terminal.



**NOTE:**

The 7402 Plus was discontinued in January, 1995.

## Applications

---

The 7402 Plus voice terminal can be used with the DEFINITY Communications System Generic 1, Generic 2, and Generic 3, the DEFINITY ECS, System 75, and System 85. This voice terminal is especially suitable for managers, executive secretaries, and other office support personnel who require access to multiple lines for call handling, call coverage, bridging, conferencing, and sophisticated voice communications.

The 7402 Plus voice terminal can also provide simultaneous voice and data communications with the 7400B Data Module. PC platform products can also be useful in providing voice capabilities since these screen-based products can greatly enhance the telephone capabilities of these basic voice terminals.

## Physical Features

---

### Dimensions



**NOTE:**

The following dimensions for the 7402 Plus voice terminal are approximate.

Width = 6-3/8 inches

Depth (front to back) = 8-3/4 inches

Height (maximum with handset in place) = 5-1/2 inches

Thickness of housing = 1-1/2 inches

## **Features**

### **Four Standard Fixed Feature Buttons**

- CONFERENCE/RING button
- DROP/TEST button
- TRANSFER button
- HOLD button

### **Message Light**

The red Message light goes on when a message is left for the user. It goes off when the user retrieves the message.

### **Call Appearance and Feature Buttons**

The 7402 Plus voice terminal has two call appearance buttons, each with a red and green status light. The 7402 Plus also has four variable feature buttons. Each of these feature buttons has a green status light next to it.

### **SELECT button**

The 7402 Plus voice terminal has a SELECT button which can be used in two ways:

- When used with the CONFERENCE/RING button, the user can select a personalized ring from eight ringing patterns.
- When used with the DROP/TEST button, the user can initiate a self-test of the lights and ringer on the voice terminal.

### **SPEAKER button**

The 7402 Plus voice terminal has a SPEAKER button which allows the user to place calls while on-hook, to monitor calls on which the user has been put on hold, or retrieve messages without lifting the handset. However, the Speaker feature is for listening only. In order to speak to the other party, the user must use the handset (the speaker must be off).

### **VOLUME control button**

When the speaker is active on the 7402 Plus voice terminal speaker, the VOLUME control button affects the loudness of the Speaker (listen-only) feature.

At all other times (when the speaker is not being used), the VOLUME control button affects the volume of the tone ringer.

## **Other Physical Features**

### **Handset**

The 7402 Plus voice terminal is equipped with an R-type handset.

### **Dial pad**

The 7402 Plus voice terminal is equipped with a 12-button touch-tone dial pad. The letters "Q" and "Z" have been added to the appropriate dial pad keys for directory access, and the "5" button on the dial pad has raised bars for visually-impaired users.

### **Jacks**

The 7402 Plus voice terminal's housing contains three jacks. The Handset cord jack is on the back of the housing near the front. The Line jack and the Speakerphone/headset adapter jack on both voice terminals are on the back of the voice terminal.

### **Cords**

Two cords are supplied with the 7402 Plus voice terminal: a coiled 9-foot modular handset cord and a 7-foot D8W 8-conductor modular line cord.

Optional longer cords are available: a 12-foot handset cord; 14-foot and 25-foot line cords.

### **Ringling**

The 7402 Plus voice terminal has electronic tone ringling. With the Personalized Ringling feature, the user can choose any one of eight different ringling patterns.

The volume on the 7402 Plus voice terminal can be controlled with the VOLUME "arrow" button on the front of the voice terminal.

### **Mounting Options**

The 7402 Plus voice terminal comes equipped with a desk stand or can be wall-mounted.

### **Color Options**

The 7402 Plus voice terminal is available in black and misty cream.

## Distance Limitations

---

The maximum allowable distances of a 7402 Plus voice terminal from the DEFINITY G1, G2, G3, the DEFINITY ECS, System 75, or System 85 cabinet are shown in the following table.

**Table 11-3. Distance Limitations for the 7402 Plus Voice Terminal**

System	Port Board	Nominal Maximum Range in Feet (Meters) (See Note)	
		24 AWG	26 AWG
System 85	SN270B	3,400 (1,034)	2,200 (671)
	TN754	3,400 (1,034)	2,200 (671)
DEFINITY G2	SN270B	3,400 (1,034)	2,200 (671)
	TN754	3,400 (1,034)	2,200 (671)
DEFINITY G1 and G3, DEFINITY ECS, and System 75	TN754	3,400 (1,034)	2,200 (671)

**Note:**

These ranges can be extended to 5,000 feet (1524 m) for 24 AWG wire and 4,000 feet (1219 m) for 26 AWG wire with the use of a Data Link Protector.

---

## Power Requirements

---

The 7402 Plus voice terminal receives power from the system and does not require any external power supply. Additional external power is required when the 7402 Plus voice terminal is equipped with any adjuncts, such as an external speakerphone.

**Switch Administration**

---

**Aliasing**

The 7402 voice terminals must be aliased in the following way:

**Table 11-4. Administering the 7402 Plus Voice Terminal**

<b>If you are administering the 7402 Plus with this system:</b>	<b>The voiced terminal, must be administered as a:</b>
System 75, R1V1, V2	7403D voice terminal
System 75, R1V3	7410D
DEFINITY Generic 1, 2, or 3, or a DEFINITY ECS	7410D

**Button Numbering**

The following button diagrams of the 7402 Plus voice terminal, Figures 11-5 and 11-6, will help you administer this voice terminal when it is connected to a System 75 or a DEFINITY G1 and G3, or a DEFINITY ECS, and to a System 85 or a DEFINITY G2.

In these figures, the button numbers on the six administrable call appearance and feature buttons correspond to button assignments on Page 2 of the voice terminal administration screen form.

If you need more information, refer to *DEFINITY Communications System Generic 3 Implementation*, 555-230-653, and *DEFINITY Communications System Generic 2 Administration of Features and Hardware*, 555-104-507.

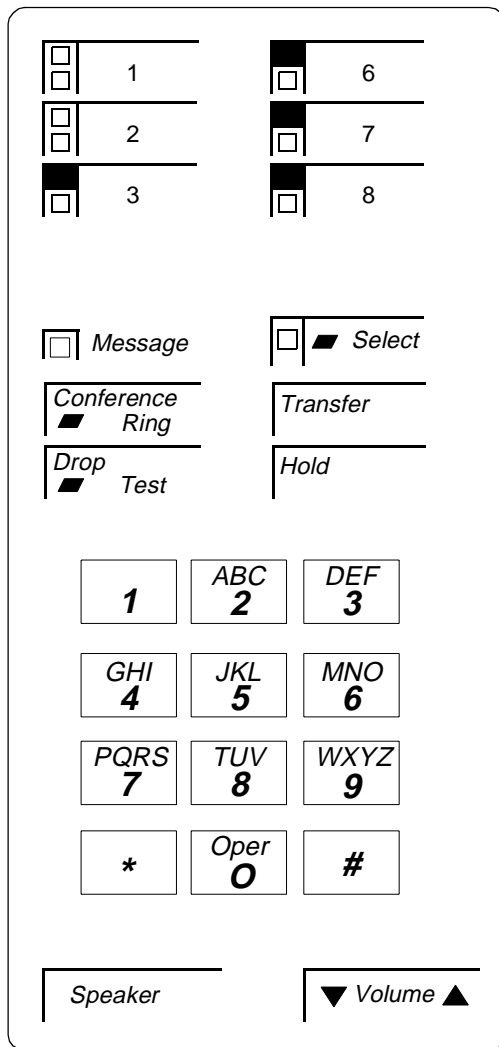

Figure 11-5. Button Numbering for Administering the 7402 Plus Voice Terminal Connected to a System 75, a DEFINITY G1 or G3, or a DEFINITY ECS

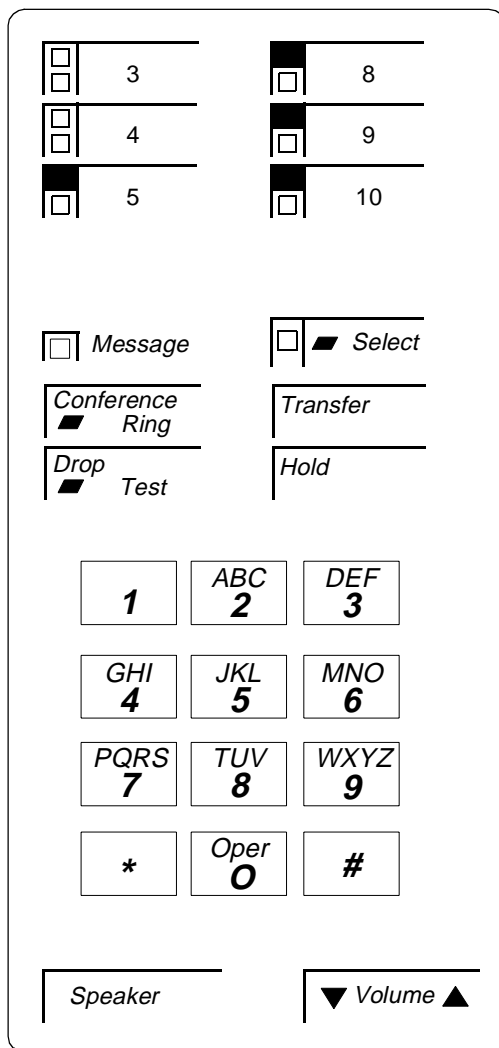

Figure 11-6. Button Numbering for Administering the 7402 Plus Voice Terminal Connected to a System 85 or a DEFINITY G2

## Power Failure Operation

The 7402 Plus voice terminal cannot be used as an emergency station during power failure transfer conditions.

## FCC Registration

The 7402 Plus voice terminal is FCC-registered along with the switch (as a system), but does not have a separate FCC registration label.

## UL and CSA Approval

This voice terminal has been tested and has met the Underwriters Laboratories (UL) Standards UL 1459 and has also met the Canadian Standards Association (CSA) Standards CSA-C22.2 No.225-M90.

## Hearing Aid Compatible

This voice terminal is compatible with the inductively coupled hearing aids prescribed by the FCC.

## 7402 Plus Equipment PECs and Comcodes

The 7402 Plus voice terminal and components were ordered with the following PECs and Comcodes:

- **Basic 7402 Plus Voice Terminal**  
PEC: 3189-PLS (Black=COL09; Misty Cream=COL22)  
Comcode: Black=105425185; Misty Cream=105425144
- **Handset**  
Comcode: Black=105519086; Misty Cream=105520787
- **Handset cord (9 feet)**  
Comcode: Black=105635429; Misty Cream=105635437
- **Handset cord (12 feet)**  
PEC: 2725-01L (Black=COL09; Misty Cream=COL22)  
Comcode: Black=102401445; Misty Cream=104211339
- **Line Cord (7 feet, silver)**  
Comcode: 103786778
- **Line cord (14 feet, silver)**  
PEC: 2725-07N (COL18)  
Comcode: 103786802
- **Line cord (25 feet, silver)**  
PEC: 2725-07S (COL18)  
Comcode: 103786828
- **Button designation card**  
PEC: 31866A (Package of 25 tractor feed cards)  
PEC: 31890A (Package of 100 tractor feed cards)



11 The 7400 Series Voice Terminals  
*The 7402 Plus Voice Terminal*

11-25

- **Single sheets**

Comcode: 846523892

Pack of 50 Comcode: 846523900

Tractor feed, 200 Sheets Comcode: 846551448

Tractor feed, 500 Sheets Comcode: 846551455

- **Faceplate**

Comcode: Black=846523876; Misty Cream=846523884  
(Package of 50)

PEC: 31867 (Black=COL09; Misty Cream=COL22)

Comcode: Black=847043304, Misty Cream=847043312

- **Desk stand/Wall mount assembly**

Comcode: 846028546

## Adjuncts

---

The following adjuncts can be used with this voice terminal:

- S101A Speakerphone (no longer orderable)
- S201A Speakerphone
- CS201A Speakerphone
- 7400B Data Module
- 500A Headset Adapter (and a standard headset; see "Headsets" below)
- R6 Amplifier Handset (PEC: 3152-002)
- R8 Noisy Location Handset (PEC: 3152-003)
- IR2H Standard Handset (PEC: 3152-019)
- Shoulder Rest

## Headsets

A list of compatible headsets, consisting of both modular and plug prong base units and selection of headpieces, appears in "Headset Adapters" in the **Adjuncts** section later in this manual.

**11** The 7400 Series Voice Terminals  
*The 7402 Plus Voice Terminal*

11-26

## **Additional Documents**

---

The following documents contain additional information relating to the 7402 Plus voice terminal: (Use the 9-digit number listed after each document to order the book from the BCS Publications Center for Lucent Technologies.)

- *DEFINITY Communications System Generic 1 and System 75 7402 Plus Voice Terminal User's Guide, 555-230-760*
- *DEFINITY Communications System Generic 2 and System 85 7402 Plus Voice Terminal User's Guide, 555-104-724*

The following document is shipped with every 7402 Plus voice terminal:

- *7402 Plus Voice Terminal Installation Instructions, 555-015-140*

## The 7403D Voice Terminal

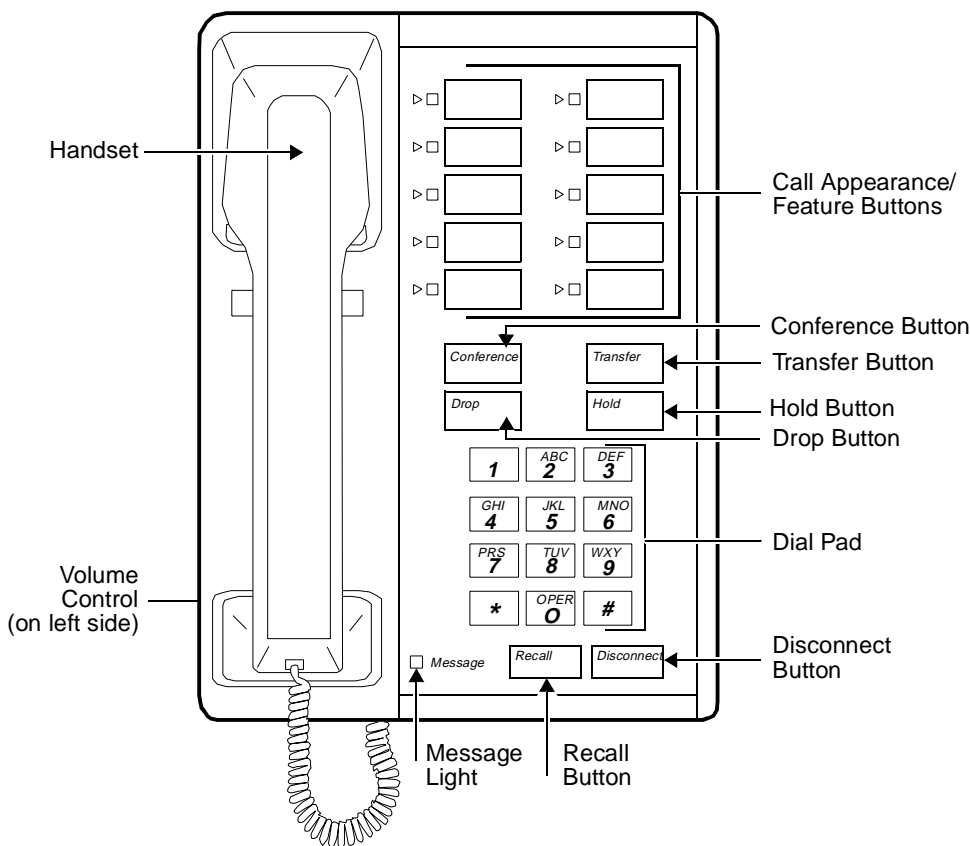

Figure 11-7. The 7403D Voice Terminal

The 7403D is a multi-appearance digital voice terminal which has 10 buttons available for line appearances, one-touch feature access, or Speed Dialing. The 7403D is a multi-appearance digital voice terminal which has 10 buttons available for line appearances, one-touch feature access, or Speed Dialing. In addition, the 7403D voice terminal may be equipped with a Digital Terminal Data Module (DTDM) which attaches to the right side and allows the connection of a EIA RS-232C data terminal.



**NOTE:**

The 7403D voice terminal has been discontinued.

## Applications

---

The 7403D voice terminal can be used with the DEFINITY Communications System Generic 1, Generic 2, and Generic 3, the DEFINITY ECS, System 75, and System 85. This voice terminal is especially suitable for managers, executive secretaries, and office support personnel. When equipped with a DTDM or 7400B, it is also suitable for users who have data terminals.

## Physical Description

---

### Dimensions



**NOTE:**

The following dimensions for the 7403D voice terminal are approximate.

Width = 7 inches

Depth (front to back) = 8-3/4 inches

Height (maximum with handset in place) = 5-1/2 inches

Thickness of housing = 1-1/2 inches

### Features

#### Six Fixed Feature Button

- RECALL button
- DISCONNECT button
- CONFERENCE button
- DROP button
- TRANSFER button
- HOLD button

#### Message light

The green Message light goes on when a message is left for the user. It goes off when the user retrieves the message.

#### Call Appearance/Feature Buttons

The 7403D voice terminal has 10 call appearance/feature buttons. Adjacent to each button is a red light and a green status indicator light.

### **Self-Test**

The 7403D voice terminal is equipped with a self-test for its buttons and tone ringer. The self-test switch is located on the left side of the base.

## **Other Physical Features**

### **Handset**

The 7403D voice terminal is equipped with an R-type handset.

### **Dial pad**

The 7403D voice terminal is equipped with a 12-button touch-tone dial pad.

### **Jacks**

The 7403D voice terminal housing contains three jacks. The handset cord jack is just under the left side of the housing. The handset contains a jack for the handset cord. The LINE and OTHER jacks are on the bottom center of the housing.

### **Cords**

Two cords are supplied with the 7403D voice terminal: a coiled 7-foot modular handset cord and a 7-foot modular line cord. Optional longer cords are available: a 12-foot handset cord; 14-foot and 25-foot line cords.

### **Ringling**

The 7403D voice terminal has electronic tone ringling. The volume control is on the left side of the housing.

### **Mounting Options**

The 7403D voice terminal comes equipped with a nonadjustable desk stand. An optional wall mounting kit can be ordered.

### **Color Options**

The 7403D voice terminal was available in black and misty cream.

## Distance Limitations

---

The maximum distance the 7403D voice terminal can be located from the system cabinet is shown in the following table.

**Table 11-5. Distance Limitations for the 7403D Voice Terminal**

System	Port Board	Nominal Maximum Range in Feet (Meters) (See Note)	
		24 AWG	26 AWG
System 85	SN270B	3,400 (1,034)	2,200 (671)
	TN754	3,400 (1,034)	2,200 (671)
DEFINITY G2	SN270B	3,400 (1,034)	2,200 (671)
	TN754	3,400 (1,034)	2,200 (671)
DEFINITY G1 and G3, DEFINITY ECS, and System 75	TN754	3,400 (1,034)	2,200 (671)

**Note:**

These ranges can be extended to 5,000 feet (1524 m) for 24 AWG wire and 4,000 feet (1219 m) for 26 AWG wire with the use of a Data Link Protector. Refer to **EXPOSED PORT PROTECTION**.

---

## Power Requirements

---

The 7403D voice terminal receives power from the system and does not require any external power supply. Additional power is required when the 7403D voice terminal is equipped with a DTDM. Refer to the **Adjunct Power** section earlier in this manual.

## Power Failure Operation

---

The 7403D voice terminal cannot be used as an emergency station during power failure transfer conditions.

## FCC Registration

---

The 7403D voice terminal is not FCC registered.

## Hearing Aid Compatible

---

This voice terminal is compatible with the inductively coupled hearing aids prescribed by the FCC.

## 7403D Equipment PECs

---

The 7403D voice terminal and optional components were ordered with the following PECs:

### NOTE:

The 7403D voice terminal has been discontinued, and thus it cannot be ordered.

- Basic 7403D Voice Terminal — 3174-16D/CLR
- Basic 7403D Voice Terminal with DTDM — 3174-16D/CLR + 31745
- Handset cord (12 feet) — 2725-01L COL09
- Line cord (14 feet, silver) — 2725-07N COL18
- Line cord (25 feet, silver) — 2725-07S COL18

## Adjuncts

---

One of the following adjuncts can be used with this voice terminal:

- S101A Speakerphone
- S201A Speakerphone (PEC 3152-007A)
- 500A Headset Adapter and a standard headset (PEC 3152-001A)
- Z701A Digital Terminal Data Module
- 7400B Data Module
- R6 Amplifier Handset (PEC 3152-002A)
- R8 Noisy Location Handset (PEC 3152-003A)

## Additional Documents

---

The following documents contain additional information relating to the 7403D voice terminal:

- *System 85 7403D Voice Terminal User's Guide*, 555-103-709
- *System 75 7403D Voice Terminal User's Guide*, 555-200-704
- *DEFINITY Generic 1 and Generic 2, System 75, and System 85 Terminals and Adjuncts Installation and Test*, 555-015-104

## The 7404D Voice Terminal

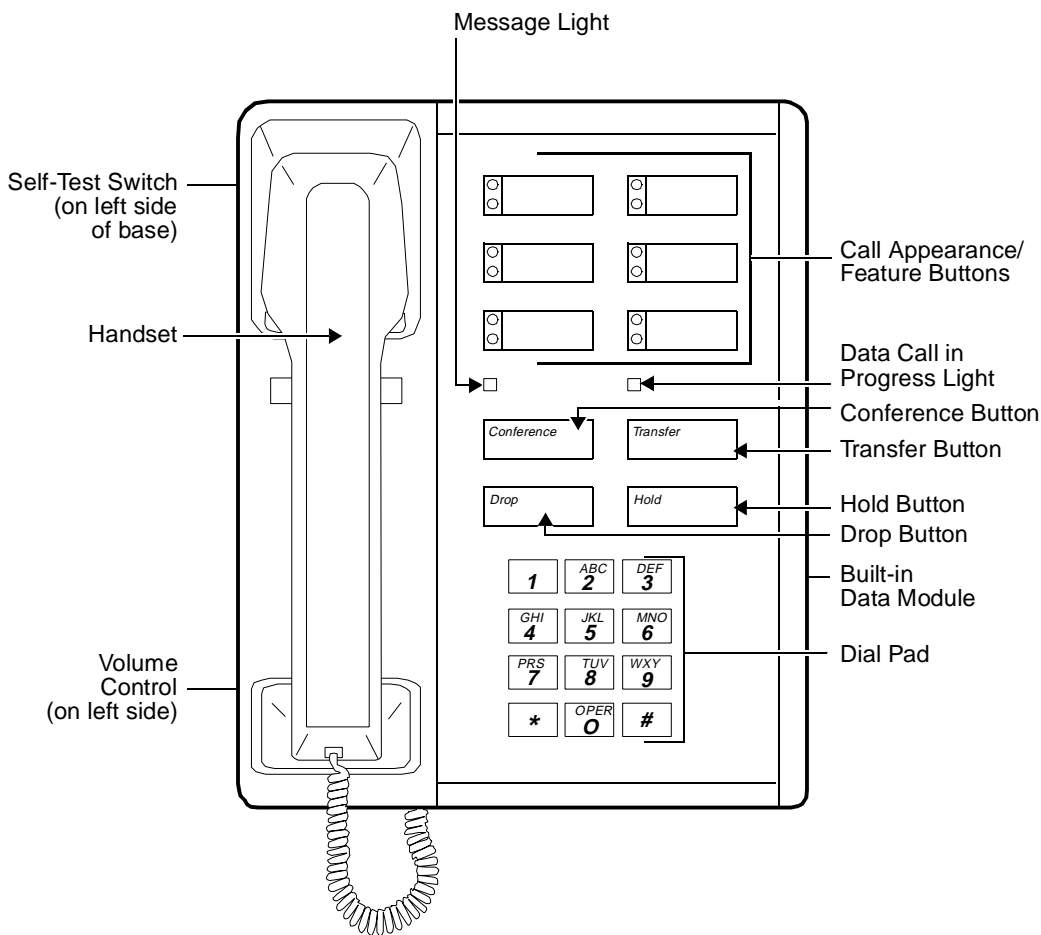

Figure 11-8. The 7404D Voice Terminal

The 7404D is a multi-appearance digital voice terminal which provides simultaneous voice/asynchronous data transmission. All the transmission is done over the same two pairs of wire.



11 The 7400 Series Voice Terminals  
The 7404D Voice Terminal

11-33

The 7404D voice terminal can be equipped with one of two different optional cartridges. The Z300B cartridge provides a display of voice call related and personal service information on an attached data terminal. The Z300C cartridge provides an interface between an NCR PC (or compatible) with the PC/PBX Connection application program and the DEFINITY Communications System Generic 2 or System 85.



**NOTE:**

The 7404D voice terminal was discontinued in February, 1989.

## Applications

---

The 7404D voice terminal can be used with the DEFINITY Communications System Generic 1 and Generic 2, Generic 3, the DEFINITY ECS, System 75, and System 85. Typical applications of the 7404D voice terminal are users who have data terminals or a PC that requires a small selection of lines and features.

## Physical Description

---

### Dimensions



**NOTE:**

The following dimensions for the 7404D voice terminal are approximate.

Width = 7 inches

Depth (front to back) = 8-3/4 inches

Height (maximum with handset in place) = 5-1/2 inches

Thickness of housing = 1-1/2 inches

### Features

#### Four Fixed Feature Buttons

- CONFERENCE button
- DROP button
- TRANSFER button
- HOLD button

#### Message Light

The green Message light goes on when a message is left for the user. It goes off when the user retrieves the message.

## **Data Light**

The Data light goes on when a data call is in progress.

## **Call Appearance/Feature Buttons**

The 7404D voice terminal has six call appearance/feature buttons. Adjacent to each button is a pair of red and green indicator lights.

## **Self-Test**

The 7404D voice terminal is equipped with a self-test for its buttons and tone ringer. The self-test switch is located on the left side of the base.

## **Other Physical Features**

### **Handset**

The 7404D voice terminal is equipped with an R-type handset.

### **Dial pad**

The 7404D voice terminal is equipped with a 12-button touch-tone dial pad.

### **Jacks**

The 7404D voice terminal housing contains three jacks. The handset cord jack is just under the left side of the housing. The handset contains a jack for the handset cord. The LINE jack is on the rear housing. There is a EIA RS-232C receptacle on the rear of the voice terminal that is used to connect an associated data terminal.

### **Cords**

Three cords are supplied with the 7404D voice terminal: a coiled 7-foot modular handset cord, 7-foot modular line cord and an AC power cord. Optional longer cords are available: a 12-foot handset cord; 14-foot and 25-foot line cords.

### **Ringling**

The 7404D voice terminal has electronic tone ringling with patterns that are set at administration. The volume control is on the left side of the housing.

### **Mounting Options**

The 7404D voice terminal comes equipped with a nonadjustable data stand.

### **Color Options**

The 7404D voice terminal was available in black and misty cream.

## Distance Limitations

---

The maximum distances the 7404D voice terminal can be located from the system cabinet is shown in the following table.

**Table 11-6. Distance Limitations for the 7404D Voice Terminal**

System	Port Board	Nominal Maximum Range in Feet (Meters) (See Note)	
		24 AWG	26 AWG
System 85	SN270B	3,400 (1,034)	2,200 (671)
	TN754	3,400 (1,034)	2,200 (671)
DEFINITY G2	SN270B	3,400 (1,034)	2,200 (671)
	TN754	3,400 (1,034)	2,200 (671)
DEFINITY G1 and G3, DEFINITY ECS, and System 75	TN754	3,400 (1,034)	2,200 (671)

**Note:**

These ranges can be extended to 5,000 feet (1524 m) for 24 AWG wire and 4,000 feet (1219 m) for 26 AWG wire with the use of a Data Link Protector. Refer to **EXPOSED PORT PROTECTION**.

---

## Power Requirements

---

The 7404D voice terminal requires a three prong 115-volt AC outlet not under the control of a wall switch for power. A built in power supply converts the 115 volts to the DC power required. A 3-wire AC power cord is provided with the voice terminal. No external power adjuncts are required.

## Power Failure Operation

---

The 7404D voice terminal cannot be used as an emergency station during power failure transfer conditions.

## FCC Registration

---

The 7404D voice terminal is not FCC registered.

## Hearing Aid Compatible

---

This voice terminal is compatible with the inductively coupled hearing aids prescribed by the FCC.

## **7404D Equipment PECs**

---

The 7404D voice terminal and optional components were ordered with the following PECs:

- Basic 7404D Voice Terminal — 3181-VDS
- Handset cord (12 feet) — 2725-01L COL09
- Line cord (14 feet, silver) — 2725-07N COL18
- Line cord (25 feet, silver) — 2725-07S COL18
- Messaging Cartridge (Z300B) — 31810
- PC/PBX Feature Cartridge (Z300C) — 31815

## **Adjuncts**

---

The 7404D voice terminal cannot be equipped with an external adjunct. The data base contains a slot where optional cartridges can be installed to provide different features. These cartridges are identified in the introduction paragraph of this section.

## **Additional Documents**

---

The following documents contain additional information relating to the 7404D voice terminal:

- *System 85 7404D Voice Terminal User's Guide, 555-103-708*
- *System 75 7404D Voice Terminal User's Guide, 555-200-705*
- *DEFINITY Generic 1 and Generic 2, System 75, and System 85 Terminals and Adjuncts Installation and Test, 555-015-104*

## The 7405D Voice Terminal

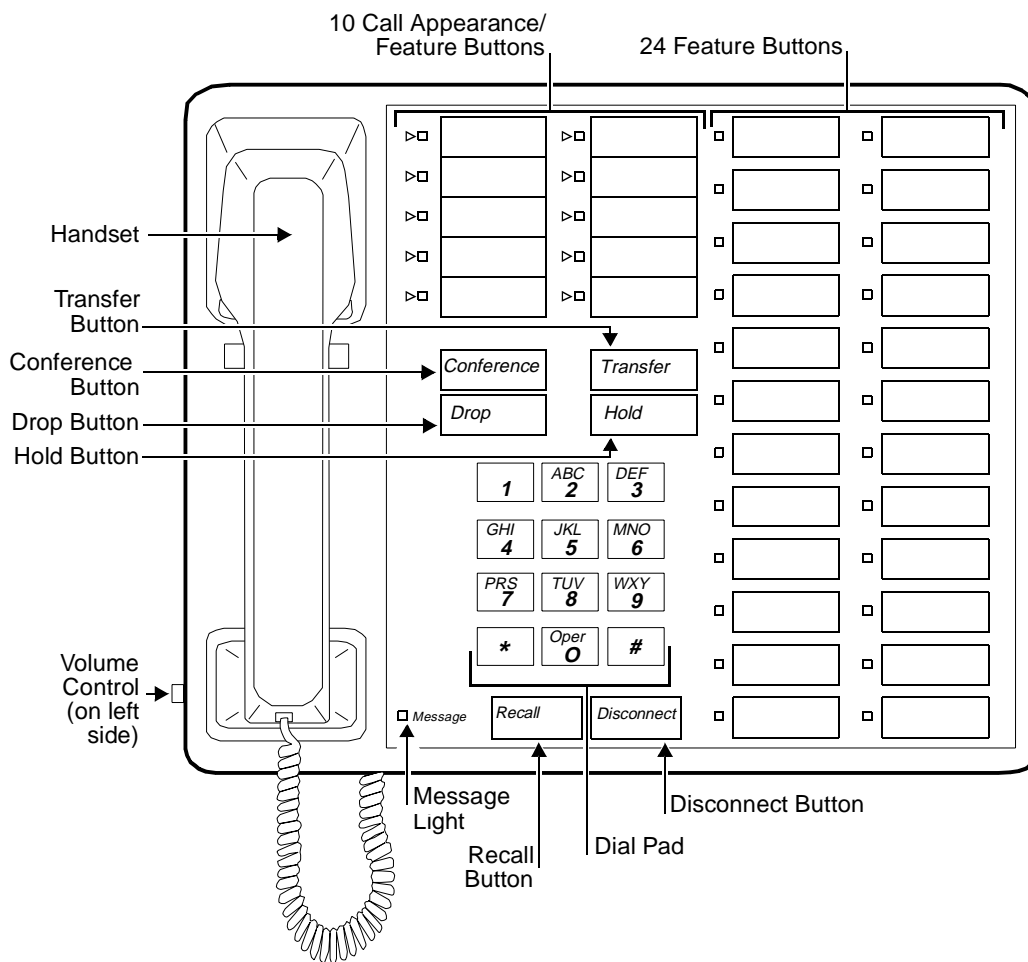

Figure 11-9. The 7405D Voice Terminal

The 7405D voice terminal is a multi-appearance digital voice terminal which allows features to be added as the user needs them. The Digital Display can be added to provide access to the Message Center. A Digital Terminal Data Module or 7400B can be added to enable the user of a 7405D voice terminal to transmit or receive data with an associated data terminal.

The basic voice terminal provides 10 call appearance/feature buttons with lights that can be assigned to call appearances or system features. It has 24 programmable feature buttons and six fixed feature buttons. The 7405D can also have a function key module which adds 24 feature buttons and a call coverage module (when no display module is used) which adds 20 call appearance/feature buttons.



**NOTE:**

The 7405D voice terminal was discontinued in February, 1990.

## Applications

---

The 7405D voice terminal can be used with the DEFINITY Communications System Generic 1, Generic 2, and Generic 3, the DEFINITY ECS, System 75, and System 85. Typical applications of the 7405D voice terminal are secretaries, executives, managers and answering positions that require a large selection of lines, features, or data transmissions.

## Physical Description

---

### Dimensions



**NOTE:**

The following dimensions for the 7405D voice terminal are approximate.

Width = 10-1/4 inches

Depth (front to back) = 8-3/4 inches

Height (maximum with handset in place) = 6-1/4 inches

Thickness of housing = 1-1/2 inches

### Features

#### Six Fixed Feature Buttons

- CONFERENCE button
- DROP button
- TRANSFER button
- HOLD button
- DISCONNECT button
- RECALL button

## **Message Light**

The green Message light goes on when a message is left for the user. It goes off when the user retrieves the message.

## **Call Appearance/Feature Buttons**

The 7405D voice terminal has 10 call appearance/feature buttons. Adjacent to each button is a pair of red and green indicator lights.

## **Feature-only Buttons**

The 7405D voice terminal has 24 feature-only buttons. Adjacent to each button is a green status light.

## **Self-Test**

The 7405D voice terminal is equipped with a self-test for its buttons and tone ringer. The self-test switch is located on the left side of the base.

## **Other Physical Features**

### **Handset**

The 7405D voice terminal is equipped with a R-type handset.

### **Dial pad**

The 7405D voice terminal is equipped with a 12-button touch-tone dial pad.

### **Jacks**

The 7405D voice terminal housing contains three jacks. The handset cord jack is just under the left side of the housing. The handset contains a jack for the handset cord. The LINE and OTHER jacks are on the rear housing.

### **Cords**

Three cords are supplied with the 7405D voice terminal: a coiled 7-foot modular handset cord and 7-foot modular line cord. Optional longer cords are available: a 12-foot handset cord; 14-foot and 25-foot line cords.

### **Ringling**

The 7405D voice terminal has electronic tone ringling. The volume control is on the left side of the housing.

### **Mounting Options**

The 7405D voice terminal comes equipped with an adjustable desk stand.

## Color Options

The 7405D voice terminal was available in black and misty cream. Since it has become discontinued, it is only available in black.

## Distance Limitations

The maximum allowable distance the 7405D voice terminal can be located from the switch cabinet is shown in the following table.

**Table 11-7. Distance Limitations for the 7405D Voice Terminal**

System	Port Board	Nominal Maximum Range in Feet (Meters) (See Note)	
		24 AWG	26 AWG
System 85	SN270B	3,400 (1,034)	2,200 (671)
	TN754	3,400 (1,034)	2,200 (671)
DEFINITY G2	SN270B	3,400 (1,034)	2,200 (671)
	TN754	3,400 (1,034)	2,200 (671)
DEFINITY G1 and G3, DEFINITY ECS, and System 75	TN754	3,400 (1,034)	2,200 (671)

**Note:**

These ranges can be extended to 5,000 feet (1524 m) for 24 AWG wire and 4,000 feet (1219 m) for 26 AWG wire with the use of a Data Link Protector. Refer to **EXPOSED PORT PROTECTION**.

## Power Requirements

The 7405D voice terminal receives power from the system and does not require any external power supply. Additional power is required when the 7405D voice terminal is equipped with any adjuncts. Refer to the **Adjunct Power** section earlier in this manual.

## Power Failure Operation

The 7405D voice terminal cannot be used as an emergency station during power failure transfer conditions.

## FCC Registration

The 7405D voice terminal is not FCC registered.



## **Hearing Aid Compatible**

---

This voice terminal is compatible with the inductively coupled hearing aids prescribed by the FCC.

## **7405D Equipment PECs**

---

The 7405D voice terminal and optional components were ordered with the following PECs:

- Basic 7405D Voice Terminal — 3175-40D/CLR
- Handset cord (12 feet) — 2725-01L COL09
- Line cord (14 feet, silver) — 2725-07N COL18
- Line cord (25 feet, silver) — 2725-07S COL18

## **Adjuncts**

---

The following adjuncts can be used with this voice terminal:

- S101A Speakerphone or 500A Headset Adapter and a standard headset
- S201A Speakerphone
- C401A or C401B Call Coverage Module or D401A or D401B Digital Display Module (but not both simultaneously)
- F401A Function Key Module
- Z701A Digital Terminal Data Module
- 7400B Data Module

## **Additional Documents**

---

The following documents contain additional information relating to the 7405D voice terminal:

- *System 85 7405D Voice Terminal User's Guide*, 555-103-709
- *System 75 7405D Voice Terminal User's Guide*, 555-200-704
- *DEFINITY Generic 1 and Generic 2, System 75, and System 85 Terminals and Adjuncts Installation and Test*, 555-015-104

# The 7406D, 7406BIS, and 7406 Plus Voice Terminals

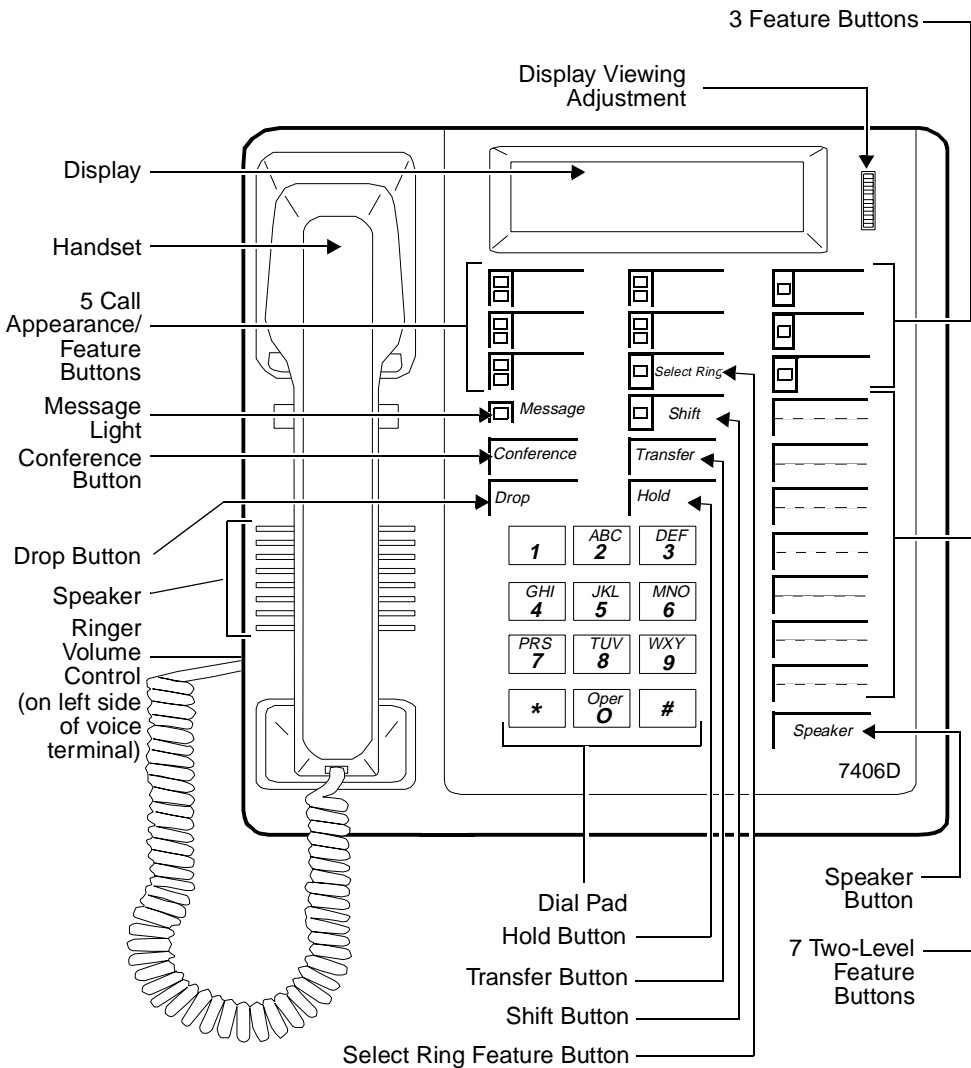

Figure 11-10. The 7406D (7406D01A or 7406D03A) Voice Terminal with Display

11 The 7400 Series Voice Terminals  
The 7406D, 7406BIS, and 7406 Plus Voice Terminals

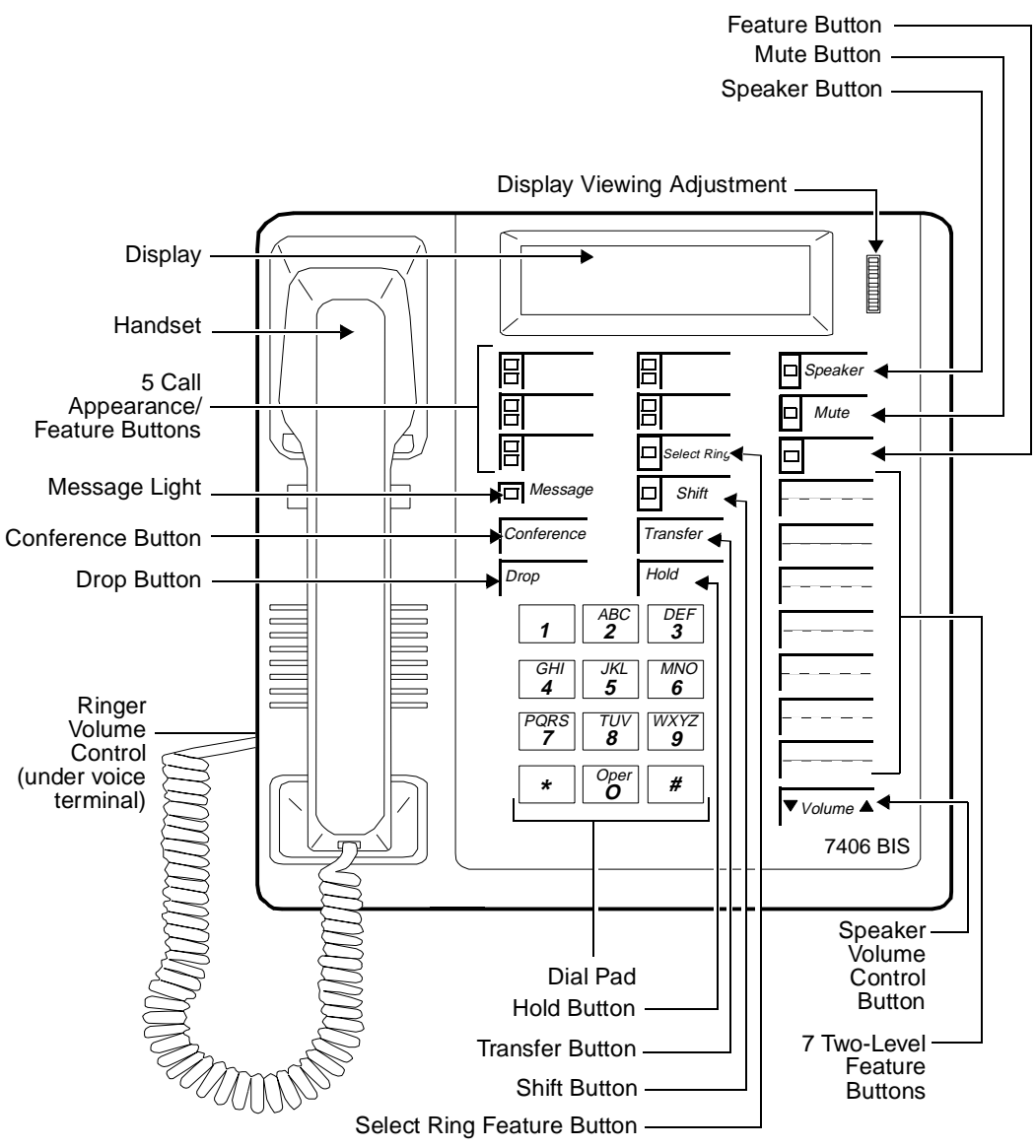

Figure 11-11. The 7406BIS (7406D05A) Voice Terminal with Display

11 The 7400 Series Voice Terminals  
 The 7406D, 7406BIS, and 7406 Plus Voice Terminals

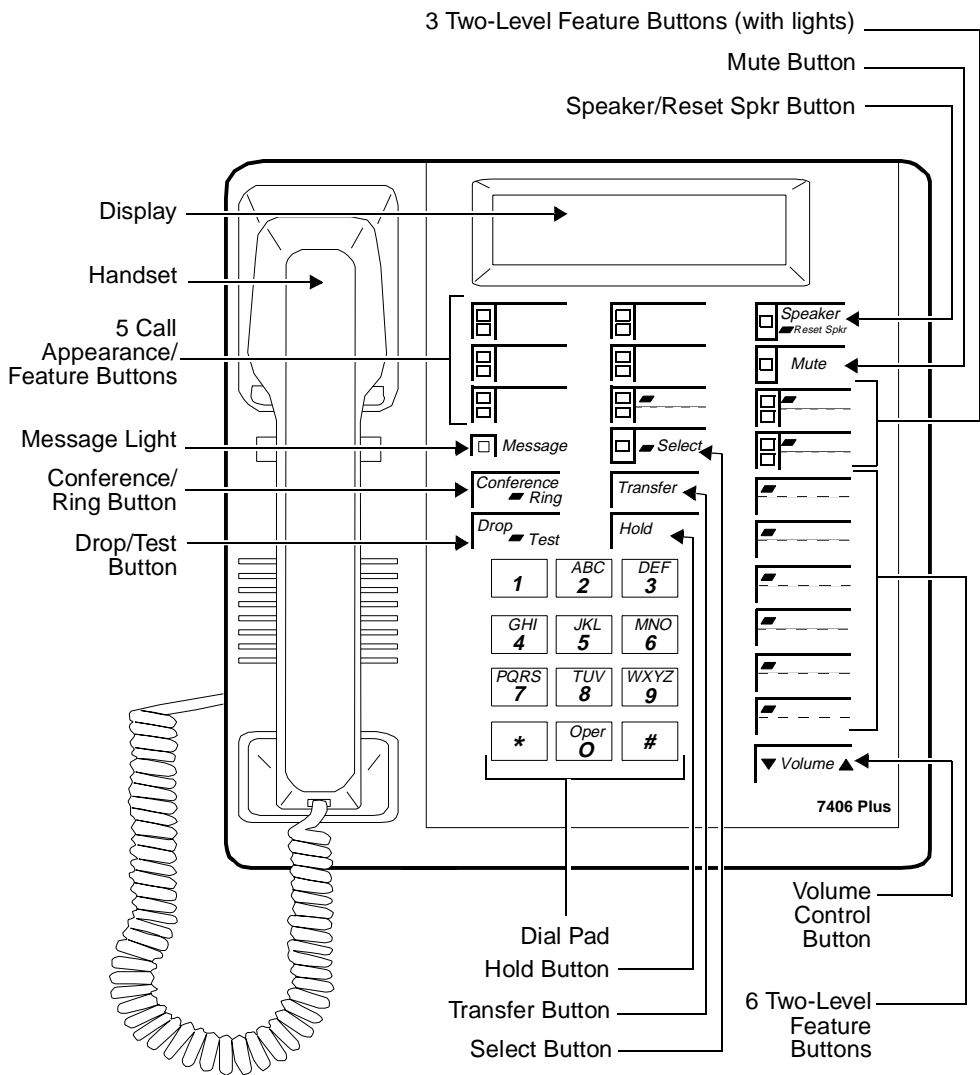

Figure 11-12. The 7406 Plus (7406D07A) Voice Terminal with Display

**11** The 7400 Series Voice Terminals  
*The 7406D, 7406BIS, and 7406 Plus Voice Terminals*

The 7406D (four versions), 7406BIS (two versions), and 7406 Plus (two versions) multi-appearance digital voice terminals are described in the following table and in the following information.

**Table 11-8. The Types of 7406 Voice Terminals**

<b>Version</b>	<b>2 x 24 Character Display</b>	<b>Data Capability with the Following</b>	<b>Built-In Speakerphone</b>
7406D01A	Yes	Z703AL1 / 7400B	No
7406D02A	No*	Z703AL1 / 7400B	No
7406D03A	Yes	7400B	No
7406D04A	No	7400B	No
7406D05A	Yes	7400B	Yes
7406D06A	No	7400B	Yes
7406D07A	Yes	7400B	Yes
7406D08A	No	7400B	Yes

---

\* Display features can be used on a data terminal if equipped with Z703AL1 DSU.

---

The 7406D (which includes the 7406D01A, 7406D02A, 7406D03A, and 7406D04A versions)— has five call appearance/feature buttons, each with a red in-use light and a green status light, seven shiftable (2-level) programmable feature buttons with no lights, four programmable feature buttons with a green light, four fixed feature buttons (CONFERENCE, TRANSFER, DROP, and HOLD), a SHIFT button with a green light, a SPEAKER button, and a green Message light.

The 7406BIS (which includes the 7406D05A and 7406D06A versions)— has five call appearance/feature buttons, each with a red in-use light and a green status light, seven shiftable (2-level) programmable buttons with no lights, two programmable feature buttons with a green light, four fixed feature buttons (CONFERENCE, TRANSFER, DROP, and HOLD), a SHIFT button with a green light, a SPEAKER button with a green light, a MUTE button with a red light, a SPEAKER VOLUME “arrow” button, and a red Message light.

11 The 7400 Series Voice Terminals

*The 7406D, 7406BIS, and 7406 Plus Voice Terminals*

11-46

The 7406 Plus (which includes the 7406D07A and 7406D08A versions)— are the newest 7406 sets. The 7406 Plus voice terminal has five call appearance/feature buttons, each with a red in-use light and a green status light, three shifttable (2-level) programmable feature buttons with a green light, six shifttable (2-level) programmable feature buttons without lights, four fixed feature buttons (CONFERENCE, TRANSFER, DROP, and HOLD), a SELECT button with a green light, a SPEAKER/RESET SPKR button with a green light, a MUTE button with a red light, a VOLUME “arrow” button, and a red Message light.

 NOTE:

The 7406D01A through 7406D06A are no longer being manufactured. The 7406D07A and 7406D08A were discontinued in 1995.

## Applications

---

The 7406D, 7406BIS, and 7406 Plus voice terminals can be used with the DEFINITY Communications System Generic 1, Generic 2, and Generic 3, the DEFINITY ECS, System 75, and System 85. These 7406 digital voice terminals are the least expensive digital voice terminals with a display that Lucent Technologies offers. Typical applications of the 7406D, the 7406BIS, and the 7406 Plus voice terminal are users who have a need for calling party display capabilities or with data terminals requiring a large number of features.

The 7406D, 7406BIS, and 7406 Plus voice terminals can also provide the user with simultaneous voice and data communications: The 7406D (7406D01A – 7406D04A) are equipped with a data stand; the 7406BIS (7406D05A and 7406D06A) and the 7406 Plus (7406D07A and 7406D08A) can be connected to a 7400B Data Module. With the 7406BIS and 7406 Plus voice terminals, PC platform products can be useful in providing voice capabilities since these screen-based products can greatly enhance the telephone capabilities of these voice terminals.

## Physical Description

---

### Dimensions

 NOTE:

The following dimensions listed here for the 7406D, 7406BIS, and 7406 Plus voice terminals are approximate.

Width = 8-1/2 inches

Depth (front to back) = 8-3/4 inches

Height (maximum with handset in place) = 6-1/4 inches

Thickness of housing = 1-1/2 inches

## Feature Buttons

The 7406D, 7406 BIS, and 7406 Plus voice terminals have the following buttons and features:

### Four Standard Fixed Feature Buttons

The 7406D, 7406BIS, and 7406 Plus have the following four standard fixed feature buttons:

- CONFERENCE or CONFERENCE/RING button
- DROP or DROP/TEST button
- TRANSFER button
- HOLD button

### Message light

The 7406D, 7406BIS, and the 7406 Plus have a Message light. The Message light goes on when a message is left for the user. It goes off when the user has retrieved the message.

### SHIFT button (on 7406D and 7406BIS)

The 7406D and 7406BIS (7406D01A—7406D06A) voice terminals have a SHIFT button which allows programming and use of a second feature or phone number for the seven double-level buttons. When the user presses the SHIFT button (and the light next to the button is on), the top-level feature on the shiftable (2-level) button can be used. (When the SHIFT button light is off, the feature assigned to the lower half of the shiftable button can be used.)

### SELECT RING button (on 7406D and 7406BIS)

The 7406D and 7406BIS (7406D01A—7406D06A) voice terminals have a SELECT RING button which is used for selecting a personalized ringing pattern. (There are eight different patterns to choose from.)

### SELECT button (on 7406 Plus only)

The 7406 Plus (7406D07A and 7406D08A) voice terminals have a SELECT button which can be used in four different ways:

- Used with a 2-level feature button to access the top-labeled feature
- Used with the DROP/TEST button to initiate a self-test of your voice terminal
- Used with the CONFERENCE/RING button to select your own personalized ring from among eight available patterns
- Used with the SPEAKER/RESET SPKR button to perform an acoustic test of the environment and adjust the speakerphone to the surrounding acoustic environment for optimal performance

11 The 7400 Series Voice Terminals  
*The 7406D, 7406BIS, and 7406 Plus Voice Terminals*

11-48

## Call Appearance/Feature Buttons

The 7406D, 7406BIS, and 7406 Plus voice terminals have five call appearance/feature buttons.

## One-level Feature-only and Two-level Feature-only Buttons

The 7406D (7406D01A—7406D04A) voice terminals have three buttons that can be used for one feature each, with a green light, and seven double-level feature buttons without lights. There is also a Select Ring/Feature button with the Select Ring option on the top level; another feature can be administered on the bottom level.

The 7406BIS (7406D05A and 7406D06A) voice terminals have one single-level feature button with a green light and seven double-level feature buttons without lights. There is also a Select Ring/Feature button with the Select Ring option on the top level; another feature can be administered on the bottom level.

The 7406 Plus (7406D07A and 7406D08A) voice terminals have three double-level feature buttons, each with a green light. These voice terminals also have six double-level feature buttons without lights.

## Speakerphone (on 7406BIS and 7406 Plus)

The 7406BIS and 7406 Plus (7406D05A—7406D08A) voice terminals are equipped with a built-in speakerphone. The Speakerphone capability allows a user to engage in a hands-free conversation with the far-end party. The speakerphone can be turned off or on (on the 7406BIS voice terminal, use the SPEAKER button; on the 7406 Plus voice terminal, use the SPEAKER/RESET SPKR button), can be muted (use the MUTE button), and the volume can be raised and lowered (use the Volume “arrow” button).

The Speakerphone feature on the 7406 Plus also allows the user to adjust the speakerphone for optimal performance. By pressing the SELECT button and then the SPEAKER/RESET SPKR button (if the voice terminal is set for the Speakerphone feature), the user hears a set of tones as the speakerphone performs an acoustic test of the environment. When the tones stop, the speakerphone has finished adjusting itself and is ready for use. The user *must* reset the speakerphone in any one of three instances: whenever the voice terminal is moved to another place (even in the same room), whenever the green light next to the SPEAKER/RESET SPKR button is fluttering, and, when, in the unlikely event, the speakerphone is making a squealing sound.

On the 7406D voice terminals, the volume control for the speaker is a sliding control also used for the tone ringer volume. On the 7406BIS voice terminal, the volume control button is labeled SPEAKER VOLUME and double arrows, one for raising the volume level and one for lowering the volume; on the 7406 Plus voice terminal, the volume control button is labeled with the word VOLUME and the double arrows for raising and lowering the volume.



11 The 7400 Series Voice Terminals  
The 7406D, 7406BIS, and 7406 Plus Voice Terminals

11-49

## Loudspeaker/Spokesman/Speaker Feature

The 7406D (7406D01A—7406D04A) voice terminals are equipped with a built-in, listen-only loudspeaker/Spokesman<sup>®</sup> capability. Use the SPEAKER button for turning on and off the loudspeaker.

The 7406BIS and the 7406 Plus (7406D05A—7406D08A) voice terminals come with a built-in speakerphone that can be optioned for Spokesman operation. (Since changing the internal jumper setting requires removing the back of the voice terminal, converting the voice terminal Speakerphone feature to the Speaker feature should be done *only* by qualified service personnel.) These voice terminals are shipped with the Speakerphone setting in place.

The Spokesman capability allows a user to engage in a one-way conversation with the far-end. Specifically, the user can only listen to the far-end; the user is not able to transmit his voice over the Spokesman. To speak with the far-end, the user must use the handset.

With the 7406D and 7406BIS voice terminals, the handset and Spokesman capability can be used simultaneously. With the 7406 Plus voice terminal, the handset and speaker *cannot* be used at the same time.

## MUTE button (on 7406BIS and 7406 Plus)

The 7406BIS and the 7406 Plus (7406D05A—7406D08A) voice terminals are equipped with a MUTE button. This button is a fixed feature button with a red status light. The MUTE button turns off the microphone of the built-in speakerphone or the handset so that a person can converse with another person in the room without the other party listening in.

## VOLUME button (on 7406BIS and 7406 Plus)

The 7406BIS (7406D05A and 7406D06A) voice terminal has a SPEAKER VOLUME “arrow” button on the bottom right side of the faceplate which controls the volume of the built-in speakerphone. The left side of the VOLUME button lowers the volume; the right side of the button raises the volume.

The 7406 Plus (7406D07A and 7406D08A) voice terminal also has a VOLUME “arrow” button on the bottom right side of the faceplate. However, this button has a double function. When the user is using the speakerphone, the VOLUME button controls the volume of the speakerphone; at all other times, the button controls the volume of the tone ringer.

If the 7406BIS or 7406 Plus voice terminal has a display (the 740605A and 7406D07A voice terminals only), the display will show a “bar array” that indicates the volume setting.

**11** The 7400 Series Voice Terminals  
*The 7406D, 7406BIS, and 7406 Plus Voice Terminals*

11-50

### **Self-Test**

Two of the 7406D voice terminals (the 7406D03A and 7406D04A) and the 7406BIS voice terminals (7406D05A and 7406D06A) are equipped with a self-test. On these voice terminals, the Self-Test feature is performed by pressing the SHIFT button and then the DROP button.

With the 7406 Plus (7406D07A and 7406D08A) voice terminals, the user presses the SELECT button and then the DROP/TEST button to initiate a self-test for the voice terminal.

During the self-test, all the lights go on, the ringer sounds, and, if the voice terminal has a display, the display characters are lit. The self-test ends when the user releases the DROP or DROP/TEST button.

## **Other Physical Features**

### **Handset**

The 7406D, 7406BIS, and 7406 Plus voice terminals are equipped with an R-type handset.

### **Dial pad**

The 7406D, 7406BIS, and 7406 Plus voice terminals are equipped with a 12-button touch-tone dial pad. On the 7406 Plus voice terminal, the letters "Q" and "Z" have been added to the appropriate dial pad keys for directory access, and the "5" button on your dial pad has raised bars for visually-impaired users.

### **Jacks**

The 7406D, 7406BIS, and 7406 Plus voice terminals' housing contains three jacks. The Handset cord jack is just under the left side of the housing. The Line jack and the Speakerphone/headset adapter jack are on the back of the voice terminal.

### **Cords**

Two cords are supplied with the 7406D, 7406BIS and 7406 Plus voice terminals: a coiled 9-foot handset cord and a 7-foot line cord.

Optional longer cords are available: a 12-foot handset cord; 14-foot and 25-foot line cords.

### **Ringling**

The 7406D, 7406BIS, and the 7406 Plus voice terminals have electronic tone ringling. With the Personalized Ringling feature, the user can select any one of eight different ringling patterns.

On the 7406D and 7406BIS (7406D01A—7406D06A) voice terminals, the volume control is on the left side of the housing.

On the 7406 Plus (7406D07A and 7406D08A), tone ringer volume is controlled by the VOLUME “arrow” button. When the speakerphone is active, the VOLUME button controls the volume of the speakerphone; at all other times, the button controls the volume of the tone ringer.

### Mounting Options

Two of the 7406D voice terminals (7406D01A and 7406D02A) come equipped with a nonadjustable desk stand, an optional data stand, or can be wall-mounted (without data capabilities).

Two of the 7406D voice terminals (7406D03A, 7406D04A), the 7406BIS (7406D05A, 7406D06A), and the 7406 Plus (7406D07A, and 7406D08A) voice terminals come with a nonadjustable desk stand only. An optional wall mount kit is available.

### Color Options

The 7406D, 7406BIS, and 7406 Plus voice terminals are available in black and misty cream.

## Distance Limitations

The maximum allowable distances of a 7406D or a 7406 Plus voice terminal from the DEFINITY G1, G2, G3, the DEFINITY ECS, System 75, or System 85 cabinet are shown in the following table.

**Table 11-9. Distance Limitations for the 7406D, 7406BIS, and 7406 Plus Voice Terminals**

System	Port Board	Nominal Maximum Range in Feet (Meters) (See Note)	
		24 AWG	26 AWG
System 85	SN270B	3,400 (1,034)	2,200 (671)
	TN754	3,400 (1,034)	2,200 (671)
DEFINITY G2	SN270B	3,400 (1,034)	2,200 (671)
	TN754	3,400 (1,034)	2,200 (671)
DEFINITY G1 and G3, DEFINITY ECS, and System 75	TN754	3,400 (1,034)	2,200 (671)

**Note:**

These ranges can be extended to 5,000 feet (1524 m) for 24 AWG wire and 4,000 feet (1219 m) for 26 AWG wire with the use of a Data Link Protector. Refer to the **Exposed Port Protection** section earlier in this manual.

## Power Requirements

The 7406D, 7406BIS, and 7406 Plus voice terminals receive power from the system and do not require any external power supply. Additional power is required when these voice terminals are equipped with any adjuncts or the Z703AL1 data stand. Refer to the **Adjunct Power** section earlier in this manual.

## Switch Administration

### Aliasing

The 7406 voice terminals must be aliased in the following way:

**Table 11-10. Administering the 7406D, 7406BIS, and 7406 Plus Voice Terminals**

If you are administering this system:	For this type of voice terminal:	The voice terminal must be administered as:
System 75, R1V1 System 85, R2V1, V2, V3	7406D 7406BIS 7406 Plus	a 7405D voice terminal (See <b>CAVEATS</b> below)
System 75, R1V2 or above DEFINITY G1 and G3, and DEFINITY ECS  System 85, R2V4 or above DEFINITY G2	7406D  7406BIS	itself
System 75, R1V2 or above DEFINITY G1 and G3, the DEFINITY ECS  System 85, R2V4 or above DEFINITY G2	7406 Plus	a 7406D voice terminal  <i>or</i>  7406BIS voice terminal

### CAVEATS:

For System 75, R1V1 and System 85, R1V2, V3, and V4, the following caveats apply:

- 7406D02A, 7406D04A, 7406D06A, 7406D08A aliased as 7405D;
- 7406D02A, 7406D04A, 7406D06A, 7406D08A w/7400B Data Module aliased as 7405 w/ Data Module;
- 7406D01A, 7406D03A, 7406D05A, 7406D07A aliased as 7405D w/Digital Display Module;
- 7406D01A, 7406D03A, 7406D05A, 7406D07A w/7400B Data Module aliased as 7405D w/Data Module and Digital Display Module;

11 The 7400 Series Voice Terminals  
The 7406D, 7406BIS, and 7406 Plus Voice Terminals

11-53

- 7406D01A and 7406D02A w/Z703A DSU aliased as 7405D w/Data Module and Digital Display Module.
- 

## Button Numbering

The 7406D and 7406 Plus voice terminal button diagrams on the following pages will help you administer the 7406D, 7406BIS, and the 7406 Plus voice terminals on a System 75, a DEFINITY G1 and G3, or a DEFINITY ECS, and on a System 85 and a DEFINITY G2. In Figures 11-13 through 11-16:

- The numbers on the five administrable call appearance and feature buttons correspond to button assignments on Page 2 of the voice terminal administration screen forms.
- The numbers on the administrable feature-only buttons correspond to feature button assignments on Page 3 of the voice terminal administration screen form.

Figures 11-13 and 11-14 refer to the button numbering for the 7406D and 7406BIS voice terminals; Figures 11-15 and 11-16 refer to the 7406 Plus voice terminal.

If you need more information, refer to *DEFINITY Communications System Generic 3 Implementation*, 555-230-653, and *DEFINITY Communications System Generic 2 Administration of Features and Hardware*, 555-104-507, for your specific system.

11 The 7400 Series Voice Terminals  
 The 7406D, 7406BIS, and 7406 Plus Voice Terminals

11-54

Administrable Call Appearance/Feature Buttons

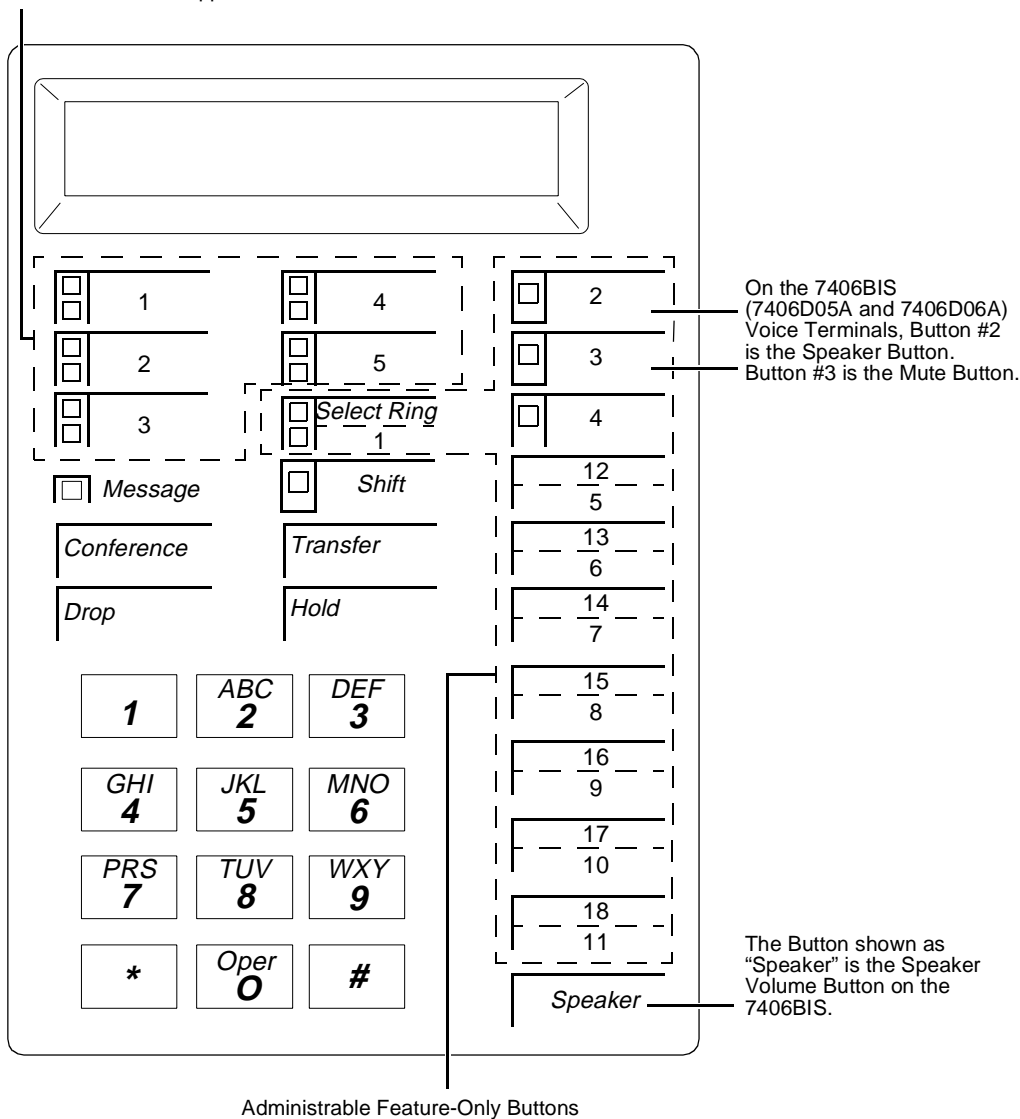
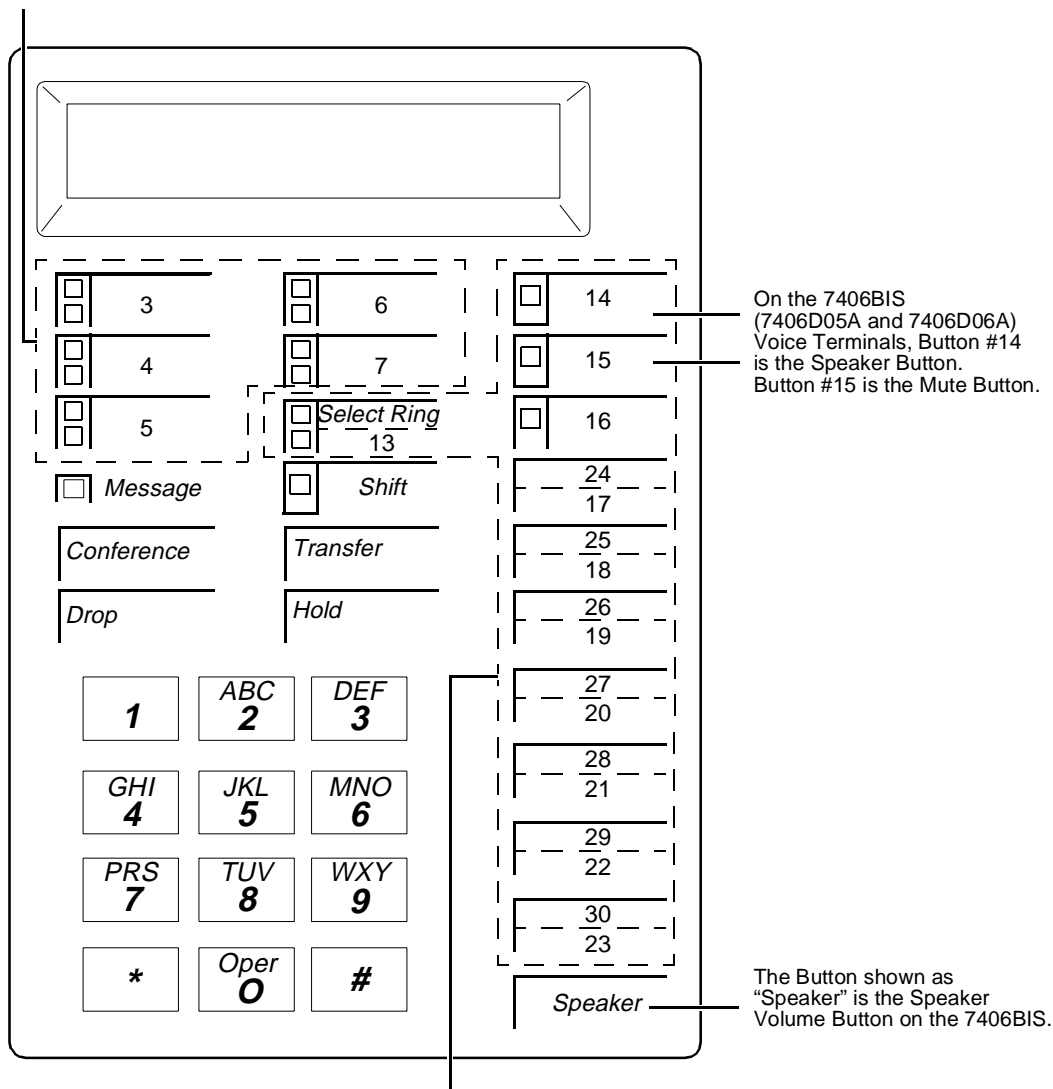

Figure 11-13. Button Numbering for Administering the 7406D and 7406BIS Voice Terminals Connected to a System 75, a DEFINITY G1 or G3, or a DEFINITY ECS

11 The 7400 Series Voice Terminals  
 The 7406D, 7406BIS, and 7406 Plus Voice Terminals

11-55

Administrable Call Appearance/Feature Buttons



Administrable Feature-Only Buttons

NOTE: The Hold Button is button #1.  
 The Message Light is Button #2.

Figure 11-14. Button Numbering for Administering the 7406D and 7406BIS Voice Terminals Connected to a System 85 or a DEFINITY G2

Administrable Call Appearance/Feature Buttons

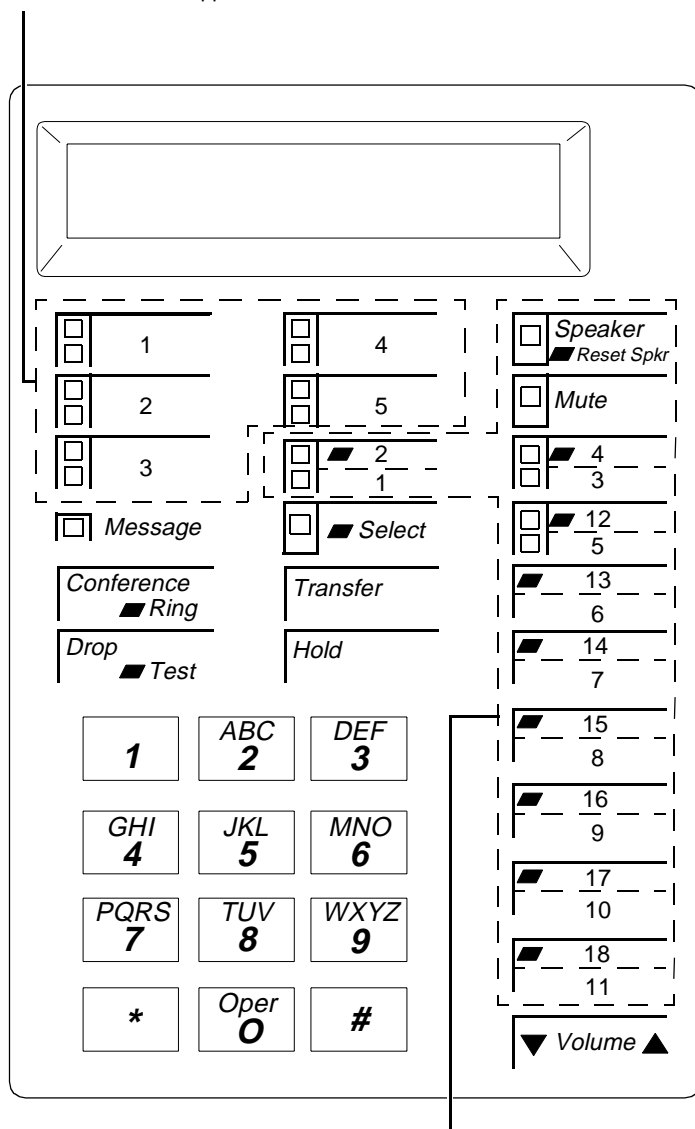

Administrable Feature-Only Buttons

Figure 11-15. Button Numbering for Administering the 7406 Plus Voice Terminal Connected to a System 75, a DEFINITY G1 or G3, or a DEFINITY ECS



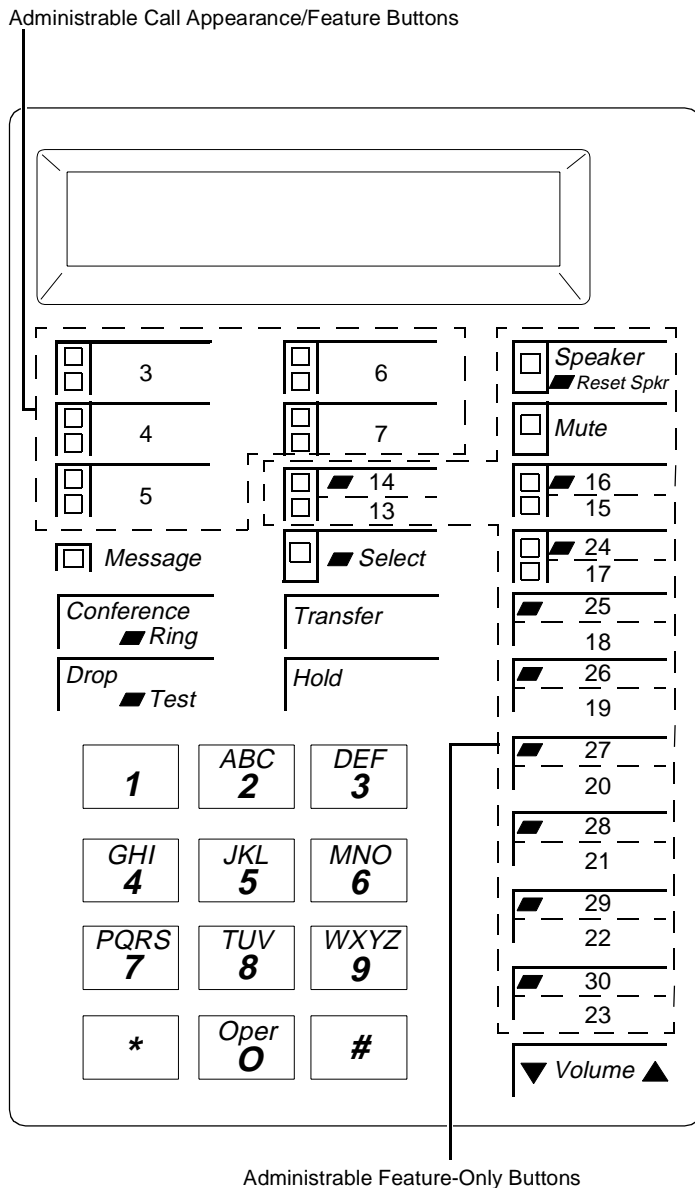

NOTE: The Hold Button is Button #1.  
 The Message Light is Button #2.

Figure 11-16. Button Numbering for Administering the 7406 Plus Voice Terminal Connected to a System 85 or a DEFINITY G2

11 The 7400 Series Voice Terminals  
*The 7406D, 7406BIS, and 7406 Plus Voice Terminals*

11-58

## Power Failure Operation

The 7406D, 7406BIS, and 7406 Plus voice terminals cannot be used as an emergency station during power failure transfer conditions.

## FCC Registration

These voice terminals are FCC-registered along with the switch (as a system), but do not have a separate FCC registration label.

## UL and CSA Approval

These voice terminals have been tested and have met the Underwriters Laboratories (UL) Standards UL 1459 and have also met the Canadian Standards Association (CSA) Standards CSA-C22.2 No.225-M90.

## Hearing Aid Compatibility

The 7406D, 7406BIS, and 7406 Plus voice terminals are compatible with the inductively coupled hearing aids prescribed by the FCC.

## 7406D/7406BIS Equipment PECs and Comcodes

The 7406D01A—7406D06A voice terminals and components can be ordered with the following PECs and Comcodes:

- **Basic 7406D01A Voice Terminal with display (and with data stand)**  
PEC: 3182-LCD (Black=COL09; Misty Cream=COL22)  
Comcode: Black= 103976536; Misty Cream=103976601
- **Basic 7406D02A Voice Terminal without display (with data stand)**  
PEC: 3183-BDT (Black=COL09; Misty Cream=COL22)  
Comcode: Black=105206585; Misty Cream=105206593
- **Basic 7406D03A Voice Terminal with display (without data stand)**  
PEC: 3182-LDM (Black=COL09; Misty Cream=COL22)  
Comcode: Black=105675417; Misty Cream=105675425
- **Basic 7406D04A Voice Terminal without display (without data stand)**  
PEC: 3183-LDM (Black=COL09; Misty Cream=COL22)  
Comcode: Black=105675433; Misty Cream=105675441
- **Basic 7406D05A Voice Terminal with display with built-in speakerphone**  
PEC: 3182-BIS (Black=COL09; Misty Cream=COL22)  
Comcode: Black=105703441; Misty Cream=105703458

11 The 7400 Series Voice Terminals  
The 7406D, 7406BIS, and 7406 Plus Voice Terminals

11-59

- **Basic 7406D06A Voice Terminal without display with built-in speakerphone**  
PEC: 3183-BIS (Black=COL09; Misty Cream=COL22)  
Comcode: Black=105703466; Misty Cream=105703474
- **Handset**  
PEC: 3152-006 (Black=COL09; Misty Cream=COL22)  
Comcode: Black=105519086; Misty Cream=105520787
- **Handset cord (9 feet)**  
Comcode: Black=105635429; Misty Cream=105635437
- **Handset cord (12 feet)**  
PEC: 2725-01L (Black=COL09; Misty Cream=COL22)  
Comcode: Black=102401445; Misty Cream=104211339
- **Line cord (7 feet, silver)**  
Comcode: 103786778
- **Line cord (14 feet, silver)**  
PEC: 2725-07N COL18  
Comcode: 103786802
- **Line cord (25 feet, silver)**  
PEC: 2725-07S COL18  
Comcode: 103786828
- **Graphic panel (for the 7406D01A, 7406D02A, 7406D03A, and 7406D04A)**  
Comcode: Black=846344331; Misty Cream=846344349
- **Graphic panel (for the 7406D05A and 7406D06A)**  
Comcode: Black=846365203; Misty Cream=846365211
- **Button designation strip**  
PEC: 31823 (Package of 25) (Black=CLR09; Misty Cream=CLR22)  
Comcode: Black=845783687; Misty Cream=845783760
- **Display bezel (for display-equipped sets)**  
Comcode: Black=846100501; Misty Cream=846781970
- **Blank bezel (for sets without display)**  
Comcode: Black=846100519; Misty Cream=845752218
- **Wall mount kits**  
(for mounting the 7406D without display)  
Comcode: 31821  
  
(for mounting the 7406D with display)  
Comcode: 31820  
  
(for mounting the 7406BIS)  
Comcode: 31830

## 7406 Plus Equipment PECs and Comcodes

The 7406 Plus voice terminal and components can be ordered with the following PECs and Comcodes:

- **Basic 7406D07A Voice Terminal with display with built-in speakerphone**  
PEC: 3182-PLS (Black=COL09; Misty Cream=COL22)  
Comcode: Black=106202443; Misty Cream=106202450
- **Basic 7406D08A Voice Terminal without display with built-in speakerphone**  
PEC: 3183-PLS (Black=COL09; Misty Cream=COL22)  
Comcode: Black=106202468; Misty Cream=106202476
- **Handset**  
PEC: 3152-006  
Comcode: Black=105519086; Misty Cream=105520787
- **Handset cord (9 feet)**  
Comcode: Black=105635429; Misty Cream=105635437
- **Handset cord (12 feet)**  
PEC: 2725-01L (Black=COL09; Misty Cream=COL22)  
Comcode: Black=102401445; Misty Cream=104211339
- **Line cord (7 feet, silver)**  
Comcode: 103786778
- **Line cord (14 feet, silver)**  
PEC: 2725-07N COL18  
Comcode: 103786802
- **Line cord (25 feet, silver)**  
PEC: 2725-07S COL18  
Comcode: 103786828
- **Graphic panel**  
Comcode: Black=846517134; Misty Cream=846517142
- **Button designation cards**  
PEC: 31827 (Package of 25 cards)  
Single card Comcode: 846519056  
25 cards Comcode: 846518124  
200 cards Comcode: 846518132  
500 cards Comcode: 846518140
- **Display bezel (for display-equipped sets)**  
Comcode: Black=846534055; Misty Cream=846534063
- **Blank bezel (for sets without display)**  
Comcode: Black=846534097; Misty Cream=846534105
- **Wall mount kit**  
Comcode: 106304298

11 The 7400 Series Voice Terminals  
*The 7406D, 7406BIS, and 7406 Plus Voice Terminals*

11-61

## Adjuncts

---

The following adjuncts can be used with this voice terminal:

- S101A Speakerphone (no longer orderable)
- S201A Speakerphone
- CS201A Speakerphone
- 7400B Data Module
- 500A Headset Adapter (and a standard headset; see “Headsets” below)
- R6 Amplifier Handset (PEC: 3152-002)
- R8 Noisy Location Handset (PEC: 3152-003)
- R2H Standard Handset (PEC: 3152-006)
- Shoulder Rest

## Headsets

A list of compatible headsets, consisting of both modular and plug prong base units and selection of headpieces, appears in “Headset Adapters” in the **Adjuncts** section later in this manual.

## Additional Documents

---

The following documents contain additional information relating to the 7406D, 7406BIS, and 7406 Plus voice terminals: (Use the 9-digit number listed after each document to order the book from the BCS Publications Center for Lucent Technologies.)

- *7406 Voice Terminal Installation Instructions*, 555-015-108
- *System 75 7406D Voice Terminal User's Guide*, 555-200-719
- *DEFINITY Communications System Generic 1 7406D Voice Terminal User's Guide*, 555-204-719
- *DEFINITY Communications System Generic 2 and System 85 7406D Voice Terminal User's Guide*, 555-104-702
- *System 75 7406BIS Voice Terminal User's Guide*, 555-200-737
- *DEFINITY Communications System Generic 1 7406BIS User's Guide*, 555-204-737
- *DEFINITY Communications System Generic 2 and System 85 7406BIS User's Guide*, 555-104-721
- *DEFINITY Communications System Generic 1 and System 75 7406 Plus Voice Terminal User's Guide*, 555-204-741
- *DEFINITY Communications System Generic 2 and System 85 7406 Plus Voice Terminal User's Guide*, 555-104-741

**11** The 7400 Series Voice Terminals  
*The 7406D, 7406BIS, and 7406 Plus Voice Terminals*

11-62

The following document is shipped with every 7406 Plus voice terminal:

- *7406 Plus Voice Terminal Installation Instructions, 555-015-126*

The following document is included with the 7406D and 7406BIS voice terminals wall kit:

- *7406BIS Wall Kit Voice Terminal Installation Instructions, 555-015-122*

The following document is included with the 7406 Plus voice terminal wall kit:

- *7406 Plus Voice Terminal Wall Kit Installation Instructions, 555-015-133*

## The 7407D, Enhanced 7407D, and 7407 Plus Voice Terminals

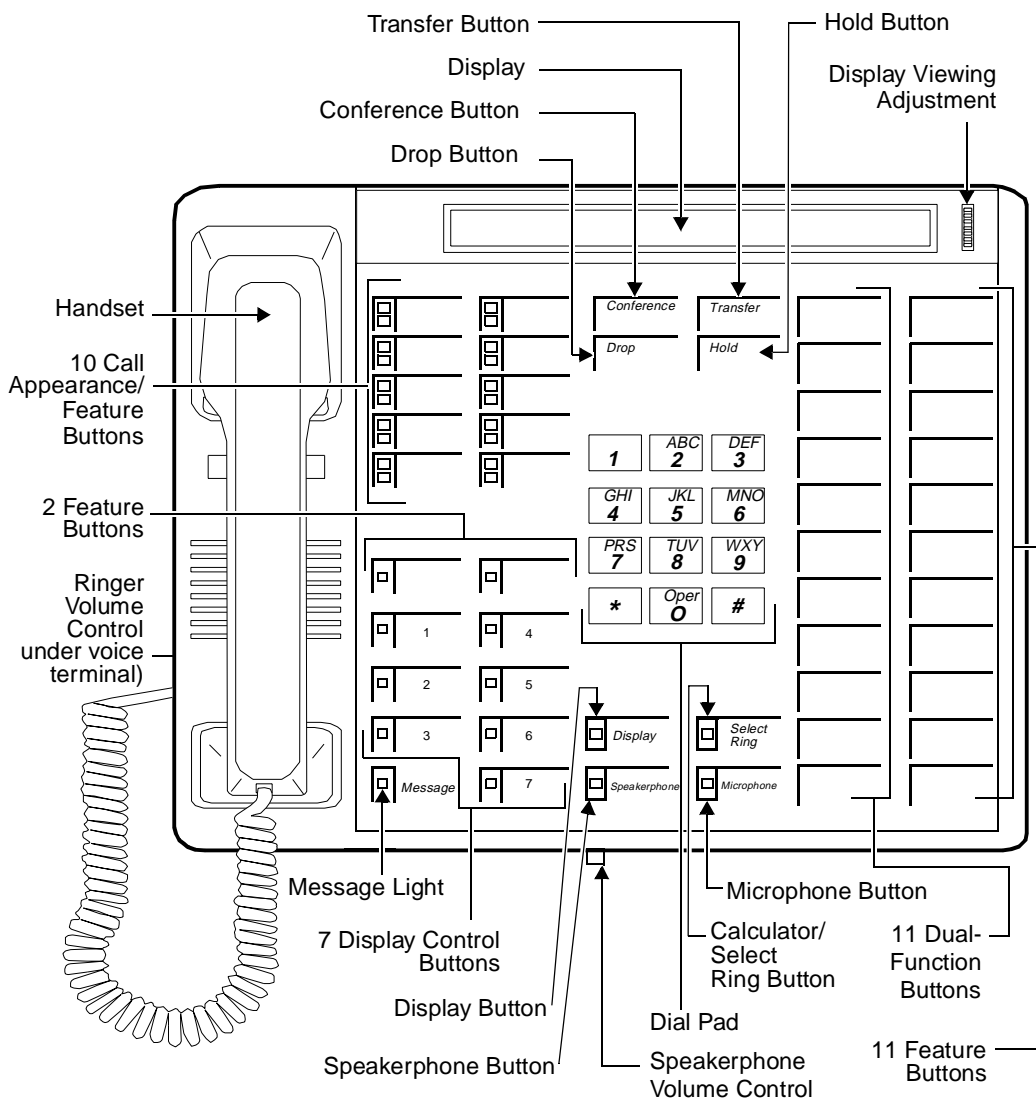

Figure 11-17. The 7407D (7407D01B) Voice Terminal

11 The 7400 Series Voice Terminals

The 7407D, Enhanced 7407D, and 7407 Plus Voice Terminals

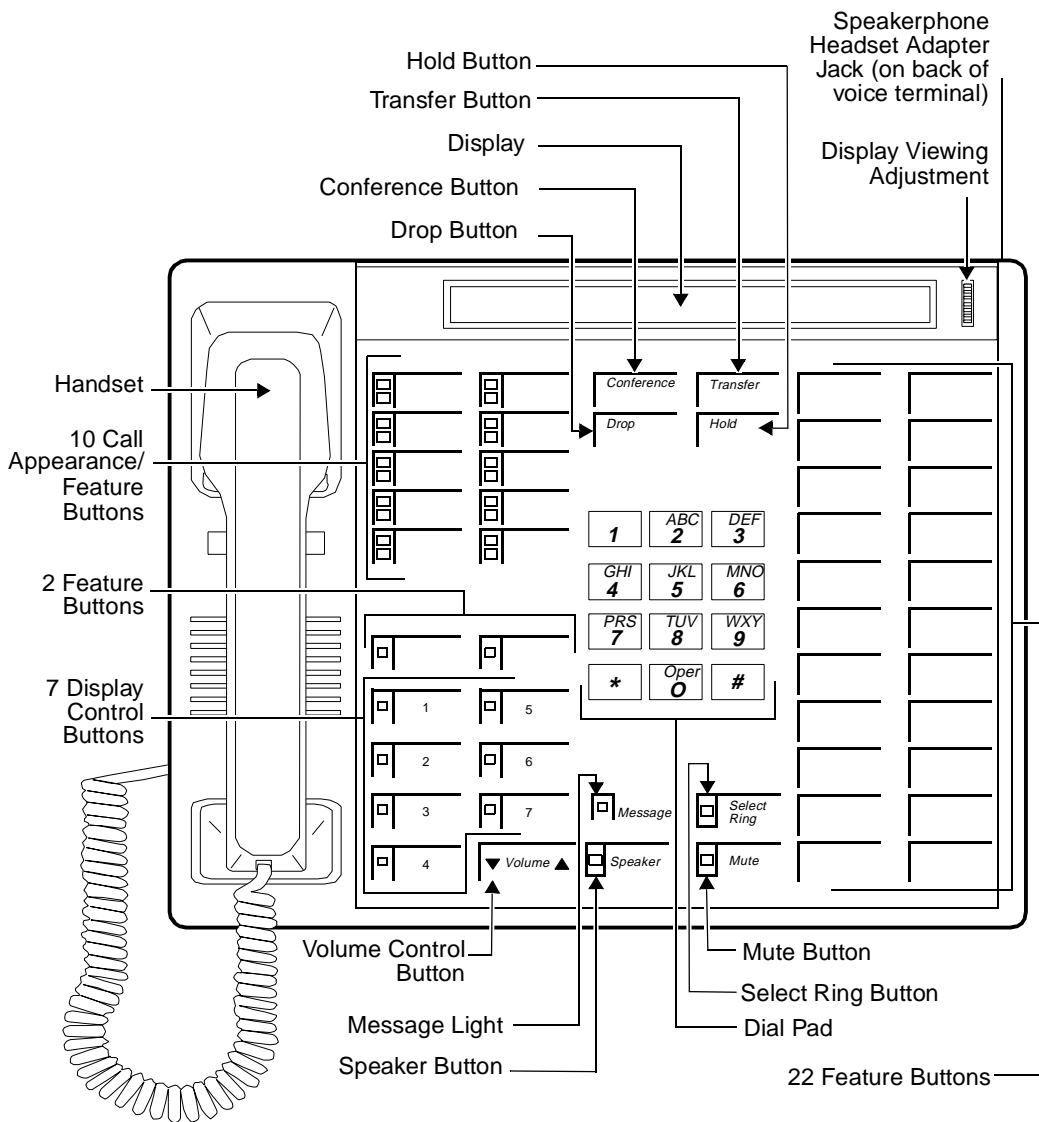

Figure 11-18. The Enhanced 7407D (7407D02C) Voice Terminal



11 The 7400 Series Voice Terminals

The 7407D, Enhanced 7407D, and 7407 Plus Voice Terminals

11-65

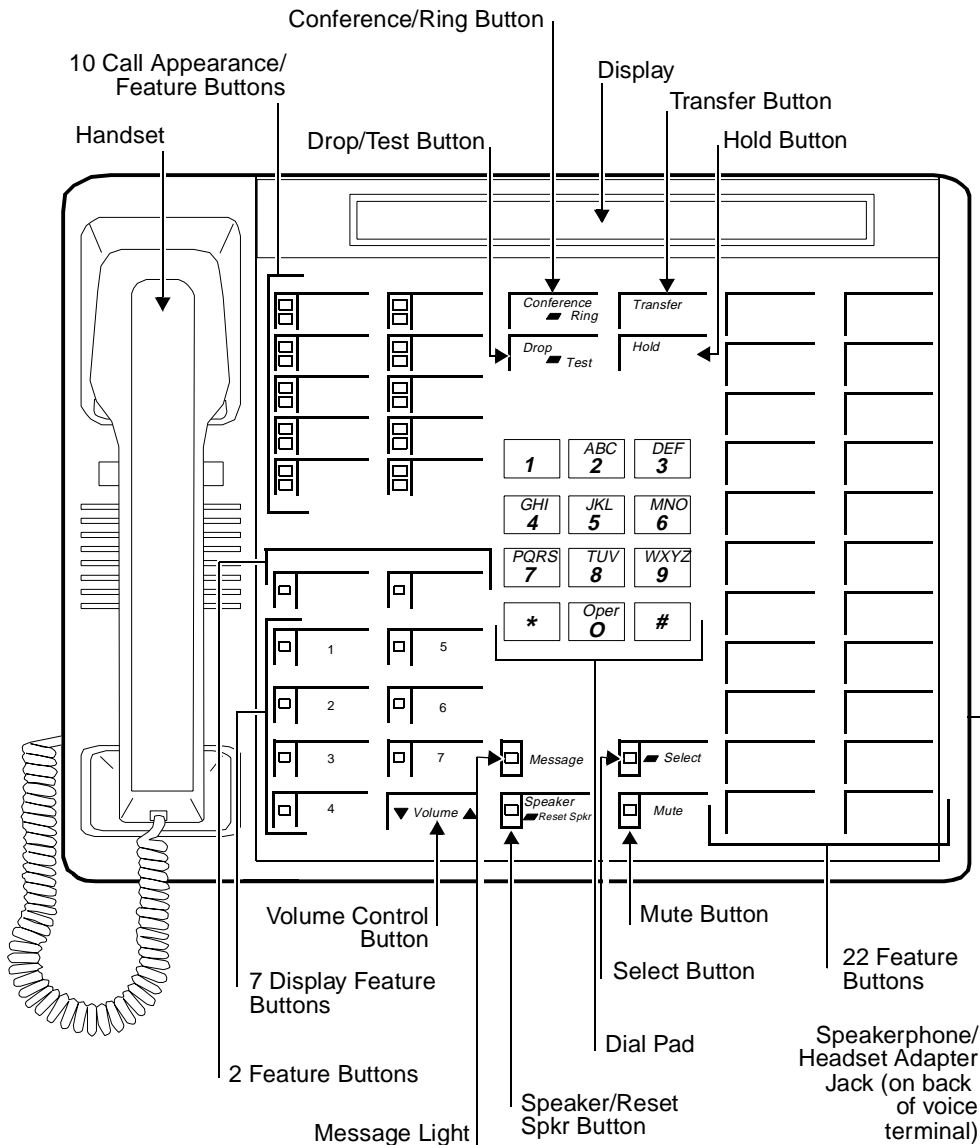

Figure 11-19. The 7407 Plus (7407D02D) Voice Terminal

**11** The 7400 Series Voice Terminals

*The 7407D, Enhanced 7407D, and 7407 Plus Voice Terminals*

11-66

The 7407D, Enhanced 7407D, and 7407 Plus voice terminals are multi-appearance digital voice terminals which provide digital voice, display, and data capabilities (the latter with the 7400B Plus Data Module). There are three versions of the 7407D voice terminal. A brief description of each of these versions is listed below:

- The 7407D (the 7407D01B)—offers 10 call appearance/feature buttons, each with a red in-use light and a green status light, four standard fixed feature buttons (CONFERENCE, DROP, HOLD, and TRANSFER), three fixed feature buttons with an associated light (CALCULATOR/SELECT RING, SPEAKERPHONE, and MICROPHONE), nine programmable feature buttons with lights (the two uppermost buttons can be used for voice or display features, the lower seven for display features), 11 dual-function buttons, 22 programmable feature-only buttons without lights, a Message light, a DISPLAY button that turns the display on and off, personalized ringing, a built-in speakerphone, a 2-line by 40-character liquid crystal display, and a built-in calculator. This voice terminal also provides the user the flexibility of adding a data stand to provide data communications. Data access can also be provided by the addition of the PC/PBX Connection Card to any AT&T compatible PC or by use of a 7400B Plus Data Module. This set is AC powered.
- The Enhanced 7407D (the 7407D02C)—offers 10 call appearance buttons, each with a red in-use light and green status light, four standard fixed feature buttons (CONFERENCE, DROP, HOLD, and TRANSFER), three fixed feature buttons with an associated light (SELECT RING, SPEAKER, and MUTE), 22 programmable feature-only buttons without lights, nine programmable feature buttons with one light each (the uppermost two buttons can be used for voice or display features, the lower seven for display features), a Message light, personalized ringing, a built-in speakerphone, a connection for an adjunct speakerphone or headset, a speakerphone with spokesman and Mute option, and a 2-line by 40-character “super-twist” liquid crystal display. Data access can be provided by the addition of the PC/PBX Connection Card to any AT&T compatible PC or by use of a 7400B Plus Data Module. This set is powered from the switch.

11 The 7400 Series Voice Terminals

*The 7407D, Enhanced 7407D, and 7407 Plus Voice Terminals*

11-67

- The 7407 Plus (the 7407D02D)—offers 10 call appearance buttons, each with a red in-use light and a green status light, four standard fixed feature buttons (CONFERENCE, DROP, HOLD, and TRANSFER), three fixed feature buttons with one light each (SELECT, SPEAKER/RESET SPKR, and MUTE), nine feature buttons with one light each (the uppermost two buttons can be used for voice or display features, the lower seven buttons for display features), 22 flexible feature buttons with no lights, a Message light, personalized ringing, a built-in speakerphone with a reset and listen-only option, and a built-in 2-line by 40-character “super-twist” liquid crystal display. Data access can be provided by the addition of the PC/PBX Connection Card to any AT&T compatible PC or by use of a 7400B Plus Data Module. This voice terminal is powered from the switch.



**NOTE:**

None of the 7407 voice terminals are being manufactured.

## Applications

---

The 7407D, Enhanced 7407D, and 7407 Plus voice terminals can be used with the DEFINITY Communications System Generic 1, Generic 2, and Generic 3, the DEFINITY ECS, System 75, and System 85. Typical applications of the 7407D, Enhanced 7407D, and the 7407 Plus voice terminal are managers, executives, or secretaries who need the robust, 2-line by 40-character display capability or with data terminals requiring a large number of features and lines.

## Special Operational Characteristics

---

The 7407D (7407D01B) voice terminal has an R1/R2 single-option toggle switch on the back of the stand; the Enhanced 7407D (7407D02C), and 7407 Plus (7407D02D) voice terminals have a 3-option DIP switch that can be accessed from the back of the stand, although, on both voice terminals only two of the options can be used. The DIP switch options can be changed with a simple tool.

### Switch Options for the 7407D and Enhanced 7407D

The following list describes the settings on the toggle switch on the 7407D (7407D01B) voice terminal and the DIP switch settings on the Enhanced 7407D (7407D02C) voice terminals:

- Since the 7407D and the Enhanced 7407D have 2-line displays, the single-option R1/R2 toggle switch on the 7407D voice terminal and Switch 1 on the DIP switch settings on the Enhanced 7407D voice terminal must be activated according to the vintage of the supporting PBX.

The 7407D voice terminal option switch is shipped in the OFF position; the Enhanced 7407D voice terminal is shipped with Switch 1 in the R2 position. These positions are the correct setting for most PBXs.

**11 The 7400 Series Voice Terminals**  
*The 7407D, Enhanced 7407D, and 7407 Plus Voice Terminals*

11-68

Use the following table to determine your PBX's release and version for setting the following switches:

- The R1/R2 switch on the 7407D01B voice terminal
- Switch 1 on the 7407D02C voice terminal

**Table 11-11. DIP Switch Settings on the 7407D and Enhanced 7407D Voice Terminals**

If the voice terminal is connected to:			Set R1/R2 to:	Set Switch 1 to:
System	Release	Version	Switch Setting	Switch Setting
System 75	1	1	R1	On
System 75	1	2 and above	R2	Off
System 85	1	All	R1	On
System 85	2	1	R1	On
System 85	2	2 and above	R2	Off
DEFINITY G1 and G3 and the DEFINITY ECS			R1	Off
DEFINITY Generic 2			R1	Off

- Switch 2 on the Enhanced 7407D (7407D02C) voice terminal controls the Spokesman option. The microphone associated with the Speakerphone can be disabled, which changes Speakerphone functionality to the Spokesman function leaving the handset active.

The Enhanced 7407D voice terminal is shipped with Switch 2 in the Speakerphone position (with the microphone enabled). This corresponds to the OFF position.

## DIP Switch Options for the 7407 Plus

For the 7407 Plus (7407D02D) voice terminal, the 3-position DIP switch should be set in the following way:

- Initially, Switch 1 is set to the OFF position. However, according to the release and version of the System 75 or 85 to which the voice terminal is connected, you may need to change Switch 1 to the ON position. Check the following table for this information.

**Table 11-12. DIP Switch Settings on the 7407 Plus Voice Terminal**

If the voice terminal is connected to:			Set Switch 1 to:
System	Release	Version	Switch Setting
System 75	1	1	On
System 75	1	2 and above	Off
System 85	1	All	On
System 85	2	1	On
System 85	2	2 and above	Off
DEFINITY Generic 1			Off
DEFINITY Generic 2			Off

### NOTE:

If this switch is not set correctly, the display will not work properly. For example, the call appearance display, usually on the top line, may appear on the second line instead.

- Switch 2 is set for the Speakerphone feature (to the OFF position). If the voice terminal is to be set for the Speaker (listen-only) feature, set Switch 2 to the ON position.

### NOTE:

In order to allow the system to recognize this change in the setting, you must disconnect the voice terminal and then plug it in again.

- Switch 3, on the 7407 Plus voice terminal, is not to be used at this time.

11 The 7400 Series Voice Terminals  
*The 7407D, Enhanced 7407D, and 7407 Plus Voice Terminals*

11-70

## Physical Features

---

### Dimensions



**NOTE:**

The dimensions given here for the 7407 voice terminals are approximate.

Width = 12 inches

Depth (front to back) = 8-1/2 inches

Height (maximum with handset in place) = 6-1/4 inches

Thickness of housing = 1-1/2 inches

### Features

#### Four Standard Fixed Feature Buttons

- CONFERENCE or CONFERENCE/RING button
- DROP or DROP/TEST button
- TRANSFER button
- HOLD button

#### **CALCULATOR/SELECT RING button (on 7407D only)**

This button is only on the 7407D (7407D01B) voice terminal. It toggles the 11 dual-function buttons between calculator functions on the left side of the buttons (the CALCULATOR/SELECT RING light is on) and features administered on the right side of the buttons (the CALCULATOR/SELECT RING light is off). The button can also be used with the PR (Personalized Ring) button to select one of eight possible personalized ringing patterns.

#### **SELECT RING button (on Enhanced 7407D only)**

This button is on the Enhanced 7407D (7407D02C) voice terminal. It toggles between the Select Ring function (selecting a personalized ringing pattern from eight available patterns) and Self-Test function (tests the lights, ringer, and display).

### SELECT button (on the 7407 Plus only)

The **7407 Plus** (7407D02D) voice terminal has a SELECT button which can be used in three different ways:

- Used with the DROP/TEST button to initiate a self-test of your voice terminal (which tests the lights, tone ringer, and display)
- Used with the CONFERENCE/RING button to select your own personalized ring from among eight available patterns
- Used with the SPEAKER/RESET SPKR button to perform an acoustic test of the environment and adjust the speakerphone to the surrounding acoustic environment for optimal performance

### Message light

The Message light goes on when a message is left for the user. It goes off when the user retrieves the message or when the message is erased. On the 7407D (7407D01B) voice terminal, the Message light is green; on the Enhanced 7407D and the 7407 Plus voice terminals, the Message light is red.

### Call Appearance/Feature Buttons

The 7407D, Enhanced 7407, and 7407 Plus voice terminals have 10 call appearance/feature buttons.

### Feature-only Buttons on the 7407D (7407D01B)

The 7407D (7407D01B) voice terminal has the following sets of feature buttons:

- 11 feature buttons in the rightmost column, all without lights, which can be used for features only.
- 11 dual-function buttons without lights, in the second column from the right are used as dual-function (calculator) buttons.
  - When the CALCULATOR/SELECT RING button is active (the green light next to the CALCULATOR/SELECT RING button is on), the top button, labeled “PR,” is in the Select Ring mode for programming a personalized ringing pattern; the lower 10 buttons have standard hand calculator functions (which are labeled on the left of the button). These button assignments cannot be changed.
  - When the CALCULATOR/SELECT RING button is off (the green light next to the CALCULATOR/SELECT RING button is off), all 11 of these dual-function buttons have optional features (which are labeled on the right of the button). These features are assigned by the system manager.
- nine feature buttons on the bottom left, each with a green light. The two upper buttons are for voice features. The lower seven buttons are for display control functions and/or features.

### **Feature-only Buttons on the Enhanced 7407D (7407D02C)**

The Enhanced 7407D (7407D02C) voice terminal has the following sets of feature buttons:

- 22 feature buttons in the rightmost column, all without lights
- nine feature buttons on the bottom left, each with a green status light. The two upper buttons are for voice features. The lower seven buttons are for display control functions and/or features.

### **Feature-only Buttons on the 7407 Plus (7407D02D)**

The 7407 Plus (7407D02D) voice terminal has the following sets of feature buttons:

- 22 feature buttons in the rightmost column, all without lights
- nine feature buttons on the bottom left, each with a green light. The two upper buttons are for voice features. The lower seven buttons are for display control functions and/or features.

### **Speakerphone (Listen and Speak) Feature**

The 7407D, Enhanced 7407D, and 7407 Plus voice terminals are equipped with a built in speakerphone. The Speakerphone capability allows a user to engage in a hands-free 2-way conversation with the far-end party. The speakerphone can be turned off or on (use the SPEAKERPHONE button on the 7407D, the SPEAKER button on the Enhanced 7407D, and the SPEAKER/RESET SPKR button on the 7407 Plus), can be muted (use the MICROPHONE button on the 7407D; use the MUTE button on the Enhanced 7407D and 7407 Plus), and the speakerphone volume can be controlled, on the 7407D, with a slide switch, or on the Enhanced 7407D and 7407 Plus, with the VOLUME "arrow" button.

The 7407 Plus (7407D02D) voice terminal has an S201A-type speakerphone which allows the user to adjust the speakerphone for optimal performance. By pressing the SELECT button and then the SPEAKER/RESET SPKR button (if the voice terminal is set for the Speakerphone feature), the user hears a set of tones as the speakerphone performs an acoustic test of the environment. When the tones stop, the speakerphone has finished adjusting itself and is ready for use. The user should reset the speakerphone whenever the voice terminal is moved to another place (even in the same room), whenever the green light next to the SPEAKER/RESET SPKR button is fluttering, and in the unlikely event that the speakerphone is making a squealing sound.

### **Speaker (Listen-only) Feature**

The 7407 Plus voice terminal can be optioned for the Speakerphone (listen and speak) or the Speaker (listen-only) feature. The Enhanced 7407D voice terminal can be set for the Speakerphone or the Spokesman feature. (With the latter feature, the user can use the speaker and the handset simultaneously.) In order to turn on and off the speaker, use the SPEAKER button on the Enhanced 7407D, or the SPEAKER/RESET SPKR button on the 7407 Plus.



**11** The 7400 Series Voice Terminals  
*The 7407D, Enhanced 7407D, and 7407 Plus Voice Terminals*

11-73

The Speaker (listen-only) and Spokesman capability allows a user to engage in a one-way conversation with the far-end. Specifically, the user can only listen to the far-end; the user is not able to transmit his voice over the speaker. To speak with the far-end, the user must use the handset.

With the Enhanced 7407D voice terminal, the handset and Speaker capability can be used simultaneously. If you are using a 7407 Plus, you *cannot* use the handset and speaker at the same time.

These voice terminals are shipped with the Speakerphone setting in place, but the necessary DIP switch setting can be changed so that the voice terminal operates with the Speaker or Spokesman feature instead.

**MICROPHONE button (on 7407D only)**

On the 7407D (7407D01B) voice terminal, the MICROPHONE button turns the speakerphone microphone on and off.

**MUTE button (on the Enhanced 7407D and 7407 Plus)**

On the Enhanced 7407D (7407D02C) and 7407 Plus (7407D02D) the red MUTE button disables the transmitter of the speakerphone or the handset depending on which is activated at that time.

**VOLUME control button (on Enhanced 7407D and 7407 Plus)**

The Enhanced 7407D (7407D02C) and 7407 Plus (7407D02D) voice terminals have a VOLUME “arrow” button. This button has a double function. When there is a call active on the speaker or speakerphone, the VOLUME button controls the volume of the speakerphone; at all other times, the button controls the volume of the tone ringer.

When the user sets the volume for the speaker or the tone ringer, the display on the voice terminal shows a “bar array” that indicates the volume setting.

**Self-Test (on Enhanced 7407 and 7407 Plus)**

The 7407D, Enhanced 7407D (7407D02C), and 7407 Plus (7407D02D) voice terminals are equipped with a self-test.

On the 7407D (7407D01B) voice terminal, the user can test the lights, ringer, and display by pressing the Self-Test button under the left side of the set.

On the Enhanced 7407D (7407D02C) voice terminal, the user presses the SELECT RING button and then the DROP button in order to initiate a self-test of the voice terminal. On the 7407 Plus (7407D02D) voice terminal, the user presses the SELECT button and then the DROP/TEST button to start the voice terminal self-test.

**11** The 7400 Series Voice Terminals

*The 7407D, Enhanced 7407D, and 7407 Plus Voice Terminals*

11-74

During the self-test, all the lights go on, the ringer sounds, and the display character positions are lit. On the Enhanced 7407D and the 7407 Plus voice terminals, the self-test ends when the user releases the DROP or DROP/TEST button. On the 7407D voice terminal, the lights stay lit for a few seconds and then go off.

### **Display**

The 7407D, Enhanced 7407D, and 7407 Plus voice terminals are equipped with a built-in, 2-line, 40-character per line, liquid crystal display. The 7407D voice terminal has a standard, "twisted," pneumatic display; the Enhanced 7407D and 7407 Plus voice terminals have a "super-twist" display.

### **DISPLAY button (on 7407D only)**

This button is found only on the 7407D (7407D01B) voice terminal. It turns the display on and off.

### **Display Adjustment Control (on 7407D and Enhanced 7407D)**

On the 7407D (7407D01B) and Enhanced 7407D (7407D02C) voice terminals there is a thumbwheel which adjusts the viewing contrast of the display.

## **Other Physical Features**

### **Handset**

The 7407D, Enhanced 7407D, and 7407 Plus voice terminals are equipped with an R-type handset.

### **Dial pad**

The 7407D, Enhanced 7407D, and 7407 Plus voice terminals are equipped with a 12-button touch-tone dial pad. On the 7407 Plus (7407D02D) voice terminal the letters "Q" and "Z" have been added to the appropriate dial pad keys for directory access, and the "5" button on the dial pad has raised bars for visually-impaired users.

### **Jacks**

The 7407D (7407D01B) voice terminal's housing contains a Handset cord jack just under the left side of the housing, and a Line jack on the back of the voice terminal. There is an RS-232C connector on the optional data stand.

The Enhanced 7407D (7407D02C) and the 7407 Plus (7407D02D) voice terminals' housing contains a Handset cord jack just under the left side of the housing and a Line jack and Speakerphone/headset adapter jack on the back of the voice terminal.

**11 The 7400 Series Voice Terminals**

*The 7407D, Enhanced 7407D, and 7407 Plus Voice Terminals*

11-75

## **Cords**

Three cords are supplied with the 7407D (7407D01B) voice terminal: a coiled 9-foot modular handset cord, 7-foot modular line cord and an AC power cord.

Two cords are supplied with the Enhanced 7407D (7407D02C) and 7407 Plus (7407D02D) voice terminal: a coiled 9-foot modular handset cord and a 7-foot modular line cord.

Optional longer cords are available: a 12-foot handset cord, 14-foot and 25-foot line cords.

## **Ringling**

The 7407D, Enhanced 7407D, and 7407 Plus voice terminals have electronic tone ringling that can be personalized with eight possible ringling patterns selected with the Select Ring feature. On the Enhanced 7407D (7407D02C) and 7407 Plus voice terminals, the ringling volume of the second call appearance is automatically set to muted ringling.

On the 7407D (7407D01B) voice terminal, the volume control is on the left side of the housing.

On the Enhanced 7407D (7407D02C) and 7407 Plus (7407D02D) voice terminals, the volume is controlled by the VOLUME control button on the front of the voice terminal. The left side of the button lowers the volume; the right side of the button raises the volume. If a call is active on the speaker or speakerphone, the VOLUME control button adjusts the speaker or speakerphone. At all other times, the VOLUME control button controls the loudness of the tone ringer. The display screen shows a "bar array" to reflect the selected volume.

## **Mounting Options**

The 7407D (7407D01B) comes equipped with a nonadjustable desk stand or an optional data stand.

The Enhanced 7407D (7407D02CB) and 7407 Plus (7407D02D) voice terminals come equipped with a nonadjustable desk stand. The optional data stand cannot be used with these voice terminals.

## **Color Options**

The 7407D, Enhanced 7407D, and 7407 Plus voice terminals are available in black and misty cream.

**11** The 7400 Series Voice Terminals*The 7407D, Enhanced 7407D, and 7407 Plus Voice Terminals*

11-76

**Distance Limitations**

---

The maximum distances the 7407D, Enhanced 7407D, and 7407 Plus voice terminals can be located from the system cabinet are shown in the table below.

**Table 11-13. Distance Limitations for the 7407D, Enhanced 7407D, and 7407 Plus Voice Terminals**

System	Port Board	Nominal Maximum Range in Feet (Meters) (See Note)	
		24 AWG	26 AWG
System 85	SN270B	3,400 (1,034)	2,200 (671)
	TN754	3,400 (1,034)	2,200 (671)
DEFINITY G2	SN270B	3,400 (1,034)	2,200 (671)
	TN754	3,400 (1,034)	2,200 (671)
DEFINITY G1 and G3, DEFINITY ECS, and System 75	TN754	3,400 (1,034)	2,200 (671)

**Note:**

These ranges can be extended to 5,000 feet (1524 m) for 24 AWG wire and 4,000 feet (1219 m) for 26 AWG wire with the use of a Data Link Protector. Refer to the **Exposed Port Protection** section earlier in this manual.

---

**Power Requirements**

---

The 7407D (7407D01B) voice terminal requires a 3-prong 115-volt AC outlet for power. (This outlet cannot be under the control of a wall switch.) A built-in power supply converts the 115 volts to the DC power required. A 3-wire AC power cord is provided with the voice terminal. No external power adjuncts are required.

The Enhanced 7407D (7407D02C) and 7407 Plus (7407D02D) voice terminals receive power from the system and do not require any external power supply. Additional power is required when these voice terminals are equipped with any adjuncts. Refer to the **Adjunct Power** section earlier in this manual.

## Switch Administration

---

### Aliasing

The 7407 voice terminals must be aliased in the following way:

**Table 11-14. Administering the 7407D, Enhanced 7407D, and 7407 Plus Voice Terminals**

If you are administering this system:	For this type of voice terminal:	The voice terminal must be administered as:
System 75, R1V1 and System 85, R2V1	7407D Enhanced 7407D 7407 Plus	a 7405D with digital display module
System 75, R1V2 or above, DEFINITY G1 and G3, DEFINITY ECS, System 85, R2V2 or above, and DEFINITY G2	7407D	itself
System 75, R1V2 or above, DEFINITY G1 and G3, DEFINITY ECS, System 85, R2V2 or above, and DEFINITY G2	Enhanced 7407D 7407 Plus	a 7407D voice terminal

#### NOTE:

On the 7407D (7407D01B) voice terminal, the second column of 11 buttons from the right are dual-function buttons. On the left side of the button, there is a fixed calculator (or personalized ring) feature. (These *cannot* be reassigned.) These calculator/select ring features can be used when the CALCULATOR/SELECT RING button is active, and the button light is on.

The features labeled on the right side of these 11 dual-function buttons *can be* administered with system features. These administered features can be used when the CALCULATOR/SELECT RING button is not active, and the button light is off.

### Button Numbering

The following button diagrams of the 7407D and the 7407 Plus voice terminals will help you administer these voice terminals on a System 75, a DEFINITY G1 and G3, a DEFINITY ECS, and on a System 85 and a DEFINITY G2. Figures 11-20 and 11-21 refer to the 7407D; Figures 11-22 and 11-23 refer to the Enhanced 7407D voice terminal; Figures 11-24 and 11-25 refer to the 7407 Plus voice terminal.

11 The 7400 Series Voice Terminals

The 7407D, Enhanced 7407D, and 7407 Plus Voice Terminals

11-78

If you need more information, refer to *DEFINITY Communications System Generic 3 Implementation*, 555-230-653, and *DEFINITY Communications System Generic 2 Administration of Features and Hardware*, 555-104-507.

Button Assignments 1 - 10

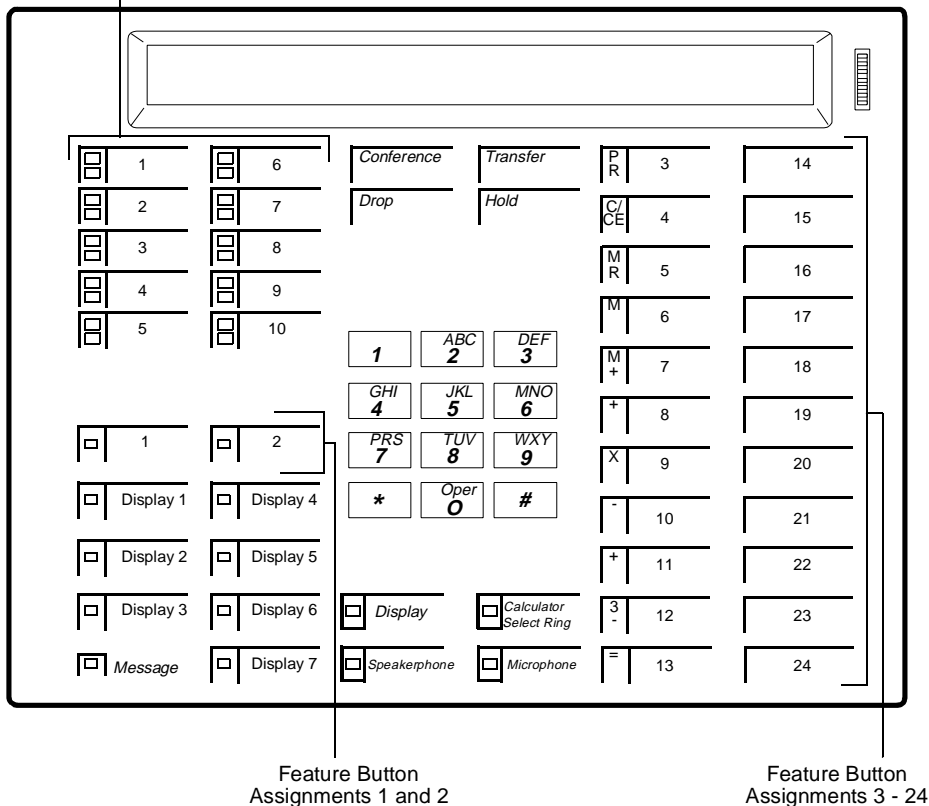

Figure 11-20. Button Numbering for Administering the 7407D (7407D01B) Voice Terminal Connected to a System 75, a DEFINITY G1 or G3, or a DEFINITY ECS

11 The 7400 Series Voice Terminals

The 7407D, Enhanced 7407D, and 7407 Plus Voice Terminals

11-79

Button Assignments 3 - 12

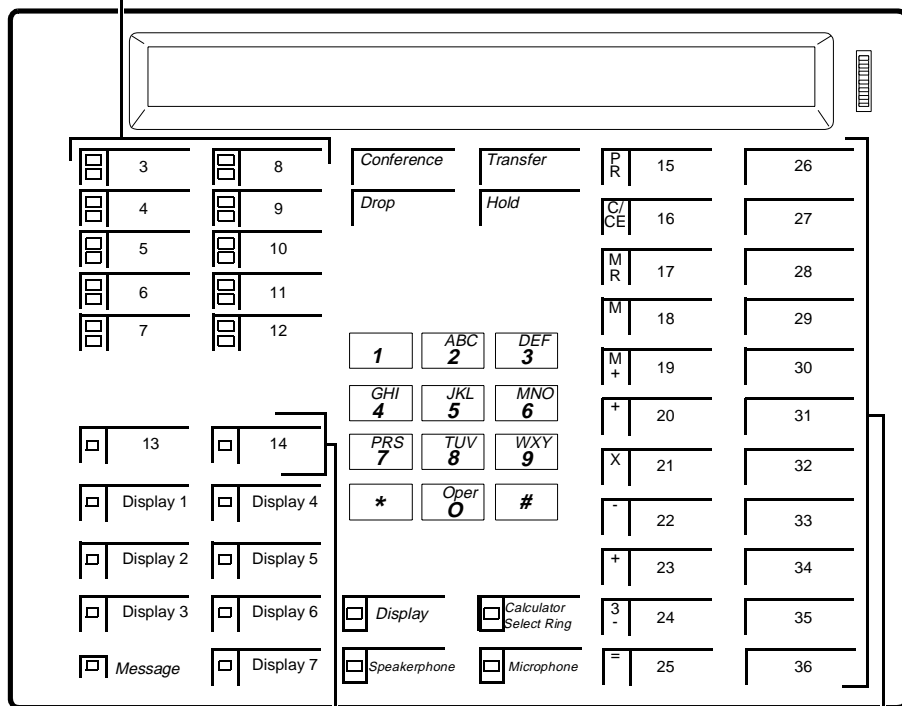

Feature Button Assignments 13 and 14

Feature Button Assignments 15 - 36

NOTE: The Hold Button is Button #1.  
 The Message Light is Button #2.

Figure 11-21. Button Numbering for Administering the 7407D (7407D01B) Voice Terminal Connected to a System 85 or a DEFINITY G2

11 The 7400 Series Voice Terminals

The 7407D, Enhanced 7407D, and 7407 Plus Voice Terminals

11-80

Button Assignments 1 - 10

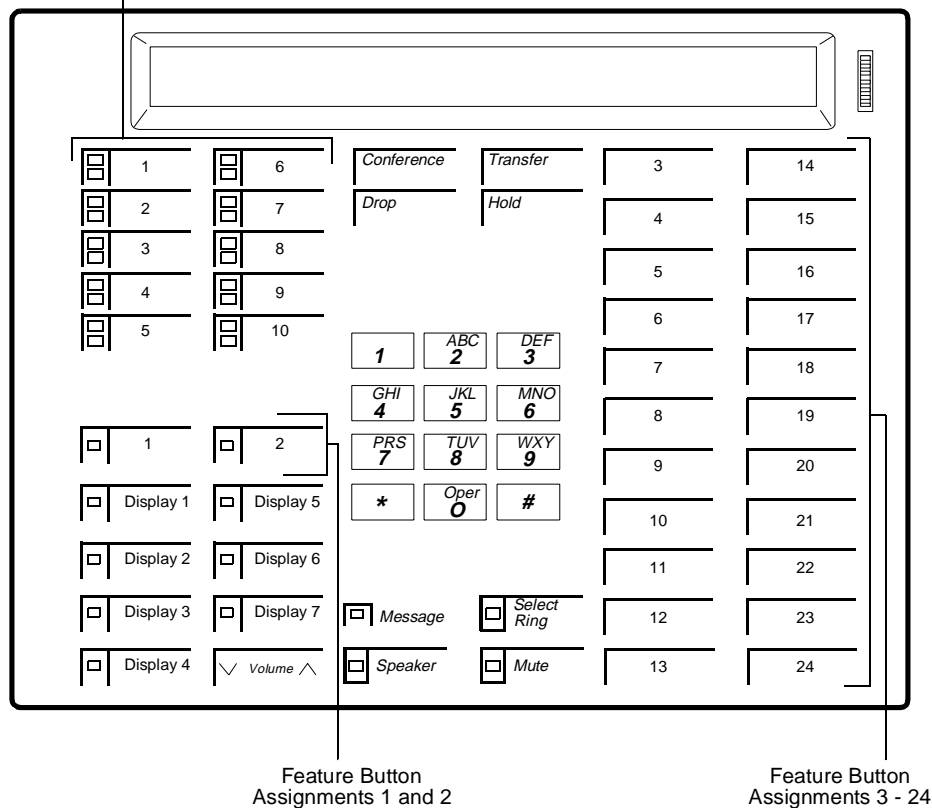

Figure 11-22. Button Numbering for Administering the Enhanced 7407D (7407D02C) Voice Terminal Connected to a System 75, a DEFINITY G1 or G3, or a DEFINITY ECS



11 The 7400 Series Voice Terminals

The 7407D, Enhanced 7407D, and 7407 Plus Voice Terminals

11-81

Button Assignments 3 - 12

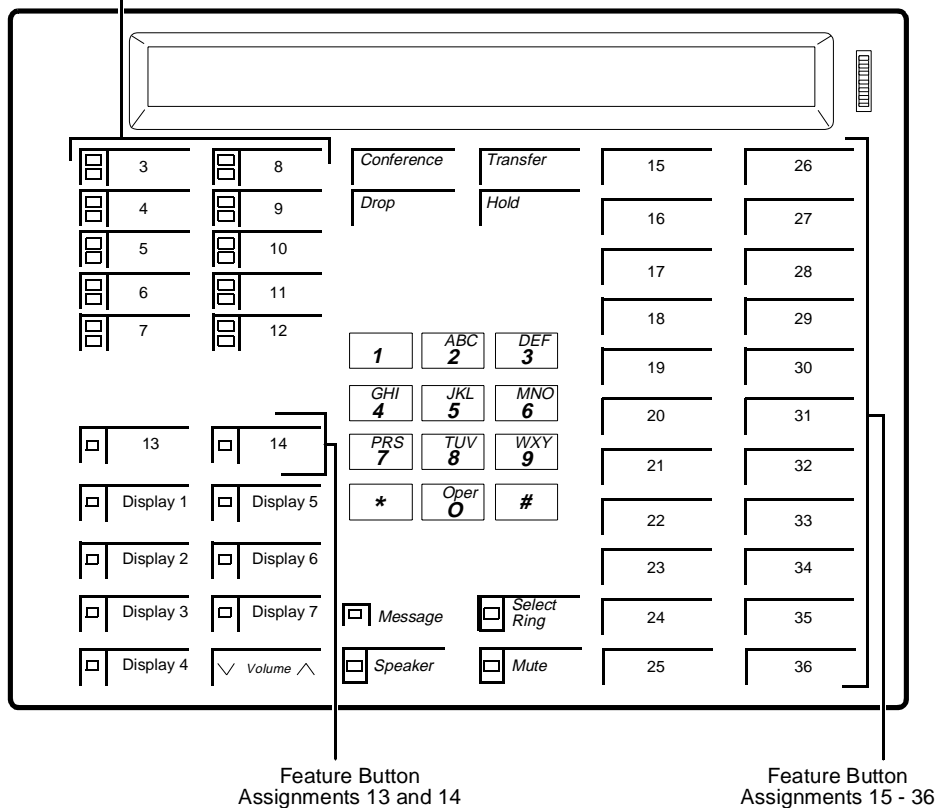

NOTE: The Hold Button is Button #1.  
 The Message Light is Button #2.

Figure 11-23. Button Numbering for Administering the Enhanced 7407D (7407D02C) Voice Terminal Connected to a System 85 or a DEFINITY G2

11 The 7400 Series Voice Terminals  
 The 7407D, Enhanced 7407D, and 7407 Plus Voice Terminals

Button Assignments 1 - 10

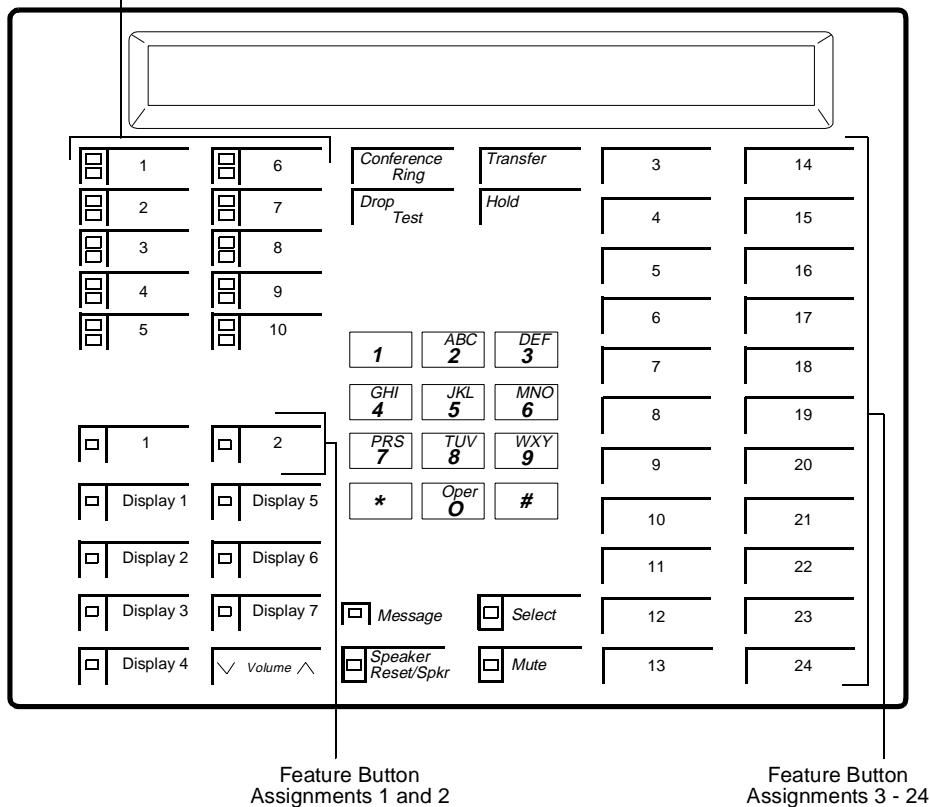

Figure 11-24. Button Numbering for Administering the 7407 Plus Voice Terminal Connected to a System 75, a DEFINITY G1 or G3, or a DEFINITY ECS

11 The 7400 Series Voice Terminals

The 7407D, Enhanced 7407D, and 7407 Plus Voice Terminals

11-83

Button Assignments 3 - 12

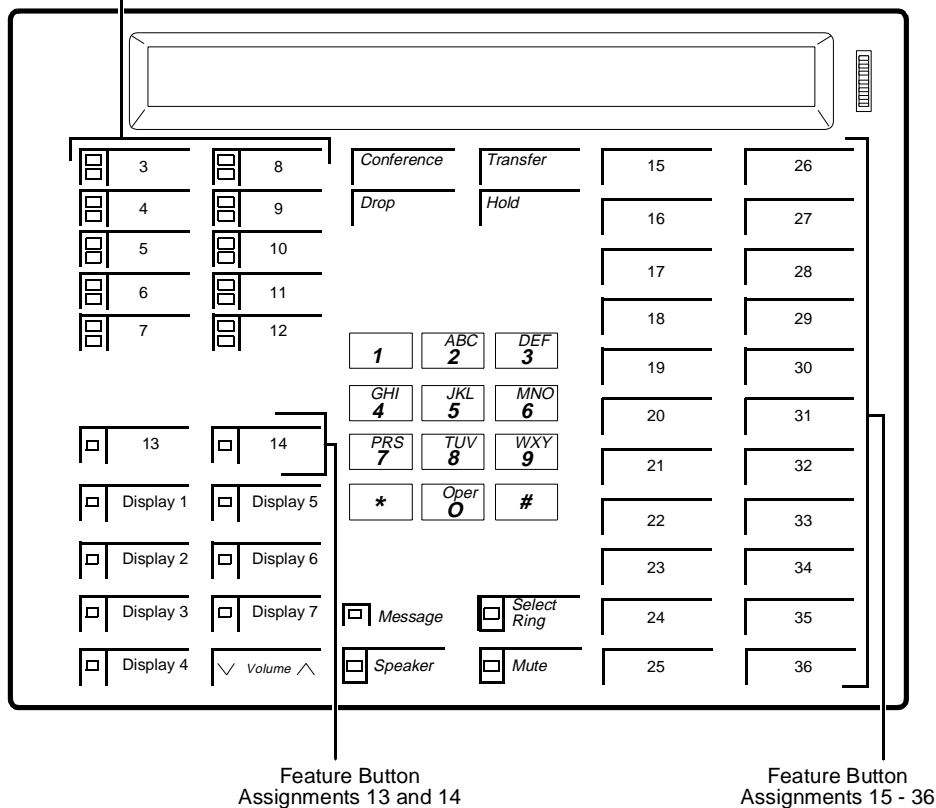

NOTE: The Hold Button is Button #1.  
 The Message Light is Button #2.

Figure 11-25. Button Numbering for Administering the 7407 Plus Voice Terminal Connected to a System 85 or a DEFINITY G2

**Power Failure Operation**

The 7407D, Enhanced 7407D, and 7407 Plus voice terminals cannot be used as an emergency station during power failure transfer conditions.

**FCC Registration**

These voice terminals are FCC-registered along with the switch (as a system), but do not have a separate FCC registration label.

11 The 7400 Series Voice Terminals  
*The 7407D, Enhanced 7407D, and 7407 Plus Voice Terminals*

11-84

## UL and CSA Approval

These voice terminals have been tested and have met the Underwriters Laboratories (UL) Standards UL 1459. In addition, the Enhanced 7407D and the 7407 Plus voice terminals have also met the Canadian Standards Association (CSA) Standards CSA-C22.2 No.225-M90.

## Hearing Aid Compatible

These voice terminals are compatible with the inductively coupled hearing aids prescribed by the FCC.

## 7407D/Enhanced 7407D Equipment PECs and Comcodes

The 7407D (7407D01B) and Enhanced 7407D (7407D02C) voice terminals and optional components can be ordered with the following PECs and Comcodes:

- **Basic 7407D01B Voice Terminal**  
PEC: 3180-IDT (Black=COL09; Misty Cream=COL22)  
Comcode: Black=103983904; Misty Cream=103983938
- **Basic 7407D02C Voice Terminal**  
PEC: 3180-PPS (Black=COL09; Misty Cream=COL22)  
Comcode: Black=105733521; Misty Cream=105733539
- **Handset**  
Comcode: Black=105519086; Misty Cream=105520787
- **Handset cord (9 feet)**  
Comcode: Black=105635429; Misty Cream=105635437
- **Handset cord (12 feet)**  
PEC: 2725-01L (Black= COL09; Misty Cream=COL22)  
Comcode: Black=102401445; Misty Cream=104211339
- **Line cord (7 feet, silver)**  
Comcode: 103786778
- **Line cord (14 feet, silver)**  
PEC: 2725-07N COL18  
Comcode: 103786802
- **Line cord (25 feet, silver)**  
PEC: 2725-07S COL18  
Comcode: 103786828

11 The 7400 Series Voice Terminals

*The 7407D, Enhanced 7407D, and 7407 Plus Voice Terminals*

11-85

- **Display Bezel**

Comcode: Black=846151876; Misty Cream=846151884

- **Button designation card**

PEC: 81004 (Package of 25)

Single Comcode: 846342038

Pack of 25 Comcode: 846342046

Tractor Feed Comcode: 846342020

## 7407 Plus Equipment PECs and Comcodes

The 7407 Plus (7407D02D) voice terminal and optional components can be ordered with the following PECs and Comcodes:

- **Basic 7407D02D Voice Terminal**

PEC: 3180-PLS (Black=COL09; Misty Cream=COL22)

Comcode: Black=106281520; Misty Cream=106281538

- **Handset**

Comcode: Black=105519086; Misty Cream=105520787

- **Handset cord (9 feet)**

Comcode: Black=105635429; Misty Cream=105635437

- **Line cord (7 feet)**

Comcode: 103786778

- **Line cord (14 feet, silver)**

PEC: 2725-07N COL18

Comcode: 103786802

- **Line cord (25 feet, silver)**

PEC: 2725-07S COL18

Comcode: 103786828

- **Button designation card**

PEC: 81004 (Package of 25)

Comcode: (Single card) Black=846604791; Misty Cream=846604809

Comcode: (Pack of 25 Sheets) Black=846692333; Misty

Cream=846692325

Comcode: (Tractor Feed, 200 Sheets) Black=846604817; Misty

Cream=846604825

11 The 7400 Series Voice Terminals

*The 7407D, Enhanced 7407D, and 7407 Plus Voice Terminals*

11-86

## Adjuncts

---

The following adjuncts can be used with these voice terminals:



**NOTE:**

Any adjunct equipment connected to the 7407 sets needs auxiliary power, except for the 7400B Plus Data Module, which is AC powered.

- S101A Speakerphone (7407D02C and 740702D)
- S201A Speakerphone (7407D02C and 7407D02D)
- 500A Headset Adapter (used with the 7407D02C and 7407D02D) (and a standard headset; see “Headsets” below)
- 7400B Data Module

## Headsets

A list of compatible headsets, consisting of both modular and plug prong base units and selection of headpieces, appears in “Headset Adapters” in the **Adjuncts** section later in this manual.

**11 The 7400 Series Voice Terminals**

*The 7407D, Enhanced 7407D, and 7407 Plus Voice Terminals*

11-87

## **Additional Documents**

---

The following documents contain additional information relating to the 7407D, Enhanced 7407D, and 7407 Plus voice terminal: (Use the 9-digit number listed after each document to order the book from the BCS Publications Center for Lucent Technologies.)

- *7407D Voice Terminal Installation Instructions*, 555-015-112
- *System 75 7407D Voice Terminal User's Guide*, 555-200-716
- *DEFINITY Communications System Generic 1 7407D Voice Terminal User's Guide*, 555-204-716
- *DEFINITY Communications System Generic 2 and System 85 7407D Voice Terminal User's Guide*, 555-104-705
- *System 75 Enhanced 7407D (7407D02C) Voice Terminal User's Guide*, 555-200-738
- *DEFINITY Communications System Generic 1 Enhanced 7407D (7407D02C) Voice Terminal User's Guide*, 555-204-738
- *DEFINITY Communications System Generic 2 and System 85 Enhanced 7407 (7407D02C) Voice Terminal User's Guide*, 555-104-723
- *DEFINITY Communications System Generic 1 and System 75 7407 Plus Voice Terminal User's Guide*, 555-204-742
- *DEFINITY Communications System Generic 2 and System 85 7407 Plus Voice Terminal User's Guide*, 555-104-742

The following instructions are shipped with every 7407 Plus voice terminal:

- *7407 Plus and 7444 Voice Terminals Installation Instructions*, 555-015-129

# The 7410D and 7410 Plus Voice Terminals

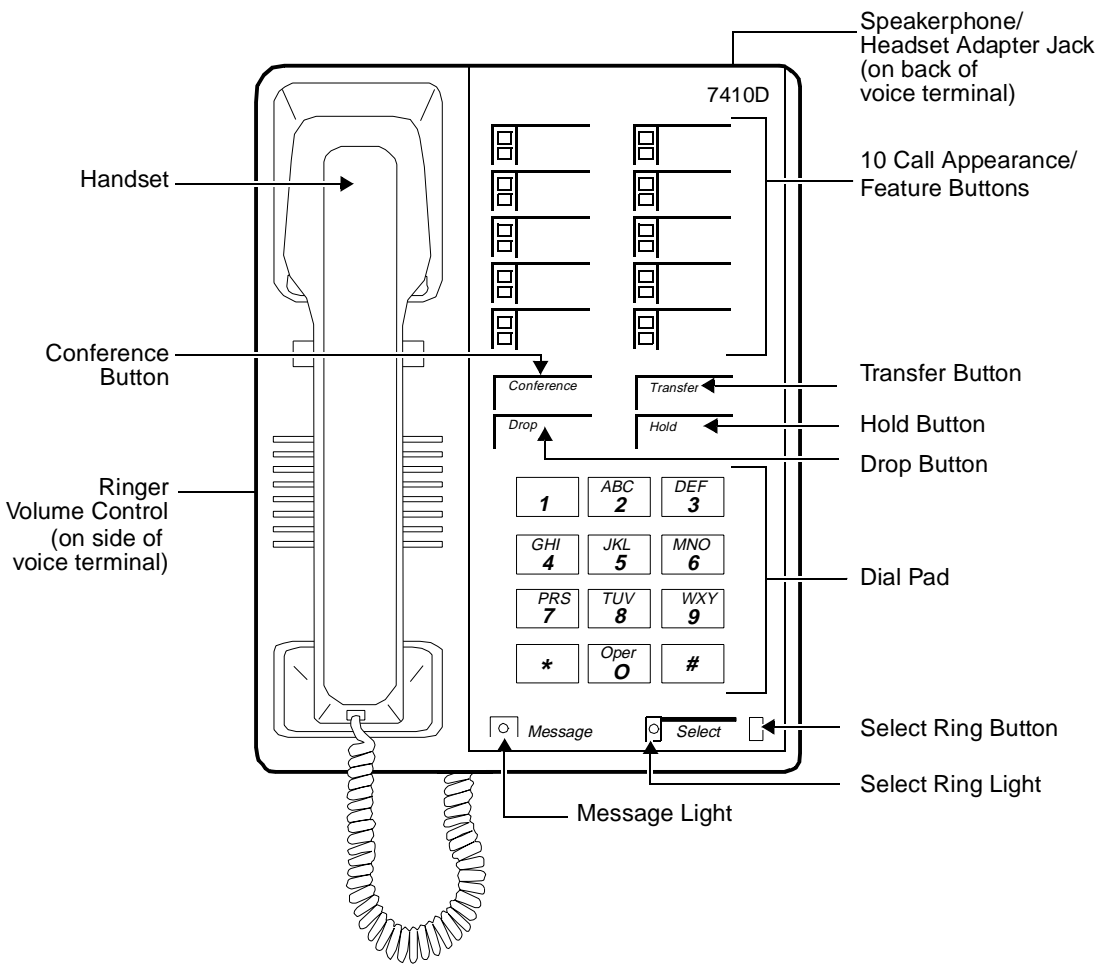

Figure 11-26. The 7410D (7401D01A) Voice Terminal



11 The 7400 Series Voice Terminals  
The 7410D and 7410 Plus Voice Terminals

11-89

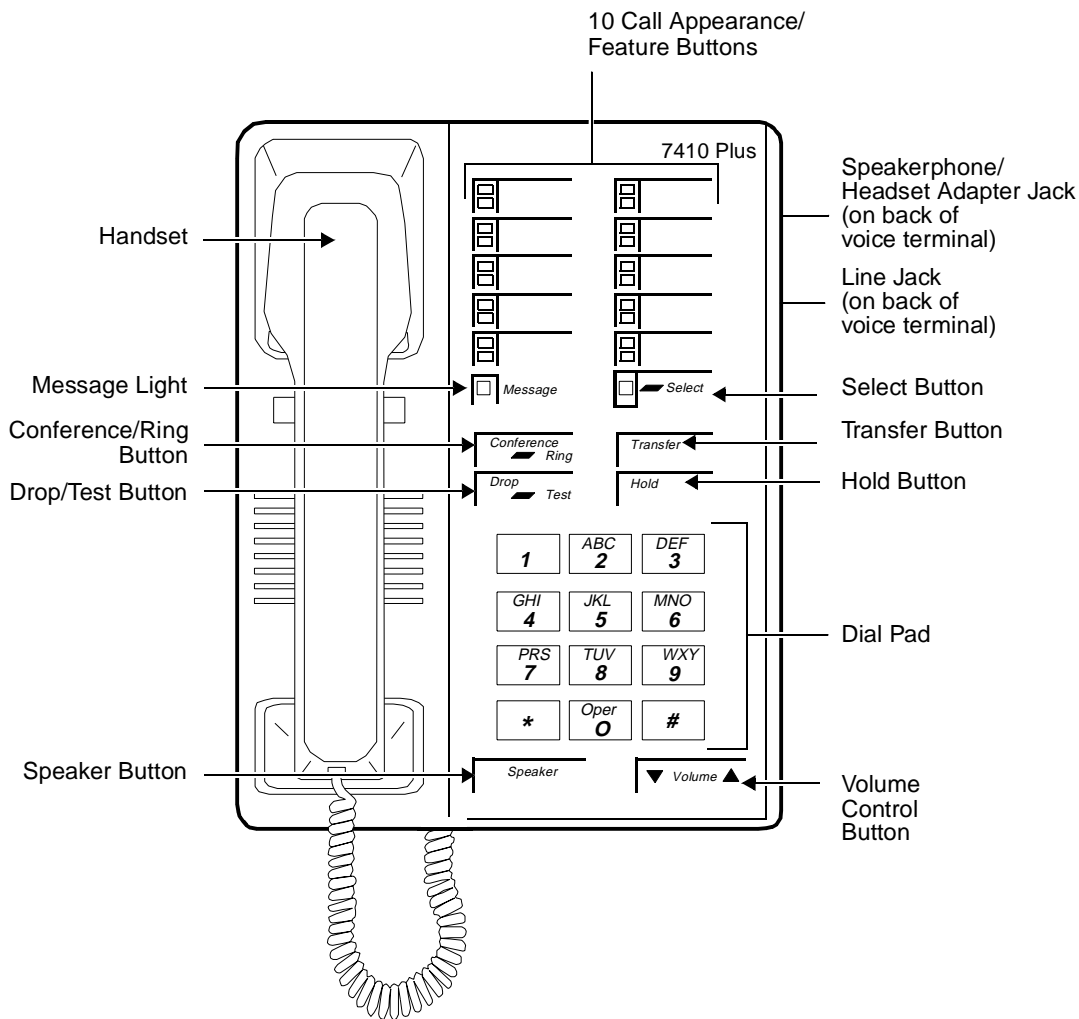

Figure 11-27. The 7410 Plus (7410D02A) Voice Terminal

11 The 7400 Series Voice Terminals  
*The 7410D and 7410 Plus Voice Terminals*

11-90

The 7410D (7410D01A) and 7410 Plus (7410D02A, the newest 7410 set) are both multi-appearance digital voice terminals with 10 line appearances, four standard fixed feature buttons and a Select Ring button. The 7410D and 7410 Plus voice terminals also provide a Message light, Ringer Volume control, a Speakerphone/headset adapter jack on the back of the voice terminal for connecting adjunct equipment, and, with the Select Ring feature, there are eight possible programmable ringing patterns. A Self-Test feature can be activated to test the lights and tone ringer on the voice terminal. In addition, the 7410 Plus (7410D02A) provides a Speaker feature for listening-only functions.



**NOTE:**

The 7401D01A is no longer being manufactured.

## Applications

---

The 7410D (7410D01A) and 7410 Plus (7410D02A) voice terminals can be used with the DEFINITY Communications System Generic 1, Generic 2, and Generic 3, the DEFINITY ECS, System 75, and System 85. These voice terminals are especially suitable for managers, executive secretaries, and other office support personnel who require access to multiple lines for call handling, call coverage, bridging, conferencing, and sophisticated voice communications.

The 7410D and 7410 Plus voice terminals can also provide simultaneous voice and data communications with the 7400B Data Module. PC platform products can also be useful in providing voice capabilities since these screen-based products can greatly enhance the telephone capabilities of these basic voice terminals.

## Physical Description

---

### Dimensions



**NOTE:**

The following dimensions for the 7410D and 7410 Plus voice terminals are approximate.

Width = 6-3/8 inches

Depth (front to back) = 8-3/4 inches

Height (maximum with handset in place) = 5-1/2 inches

Thickness of housing = 1-1/2 inches

## Features

### Four Standard Fixed Feature Buttons

- CONFERENCE or CONFERENCE/RING button
- DROP or DROP/TEST button
- TRANSFER button
- HOLD button

### Message Light

The Message light goes on when a message is left for the user. It goes off when the user retrieves the message. On the 7410D voice terminal, the Message light is green; on the 7410 Plus voice terminal, the Message light is red.

### SELECT RING button (on 7410D)

On the 7410D (7410D01A) voice terminal has a SELECT RING button, which the user can press along with the \* key on the dial pad to select one of eight personalized ringing patterns. The SELECT RING button along with the DROP button is also used to perform a self-test of the lights and tone ringer on the voice terminal. The SELECT RING button has a green status light associated with it.

### SELECT button (on 7410 Plus)

The 7410 Plus (7410D02A) voice terminal has a SELECT button which can be used in two ways:

- When used with the CONFERENCE/RING button, the user can select a personalized ring from eight ringing patterns.
- When used with the DROP/TEST button, the user can initiate a self-test of the lights and ringer on the voice terminal.

### Call Appearance/Feature Buttons

The 7410D and 7410 Plus voice terminals have 10 call appearance/feature buttons. Each of these buttons has a red in-use light and a green status light.

### SPEAKER button (on 7410 Plus)

The 7410 Plus (7410D02A) voice terminal has a SPEAKER button which allows the user to place calls while on-hook, to monitor calls on which the user has been put on hold, or retrieve messages without lifting the handset. However, the Speaker feature is for listening only. In order to speak to the other party, the user must use the handset (the speaker must be off).

### **VOLUME control button (on 7410 Plus)**

When the speaker is active on the 7410 Plus voice terminal speaker, the VOLUME control button affects the loudness of the Speaker (listen-only) feature.

At all other times (when the speaker is not being used), the VOLUME control button affects the volume of the tone ringer.

## **Other Physical Features**

### **Handset**

The 7410D and the 7410 Plus voice terminals are equipped with an R-type handset.

### **Dial pad**

The 7410D and 7410 Plus voice terminals are equipped with a 12-button touch-tone dial pad. On the 7410 Plus voice terminal the letters "Q" and "Z" have been added to the appropriate dial pad keys for directory access, and the "5" button on the dial pad has raised bars for visually-impaired users.

### **Jacks**

The 7410D and 7410 Plus voice terminals' housing contains three jacks. On the 7410D voice terminal, the Handset cord jack is located on the front of the housing; on the 7410 Plus voice terminal, this jack is on the back of the housing near the front. The Line jack and the Speakerphone/headset adapter jack on both voice terminals are on the back of the voice terminal.

### **Cords**

Two cords are supplied with the 7410D (7410D01A) and the 7410 Plus (7410D02A) voice terminal: a coiled 9-foot modular handset cord and a 7-foot D8W 8-conductor modular line cord.

Optional longer cords are available: a 12-foot handset cord, 14-foot and 25-foot line cords.

### **Ringling**

The 7401D and 7401 Plus voice terminals have electronic tone ringling. With the Personalized Ringling feature, the user can choose any one of eight different ringling patterns.

The volume control on the 7410D (7410D01A) voice terminal is on the left side of the housing.

The volume on the 7410 Plus (7410D02A) voice terminal can be controlled with the VOLUME "arrow" button on the front of the voice terminal.

### Mounting Options

The 7410D and 7410 Plus voice terminals comes equipped with a desk stand or can be wall-mounted.

### Color Options

The 7410D and 7410 Plus voice terminals are available in black and misty cream.

### Distance Limitations

The maximum allowable distances of a 7410D or a 7410 Plus voice terminal from the DEFINITY G1, G2, and G3, DEFINITY ECS, System 75, or System 85 cabinet are shown in the following table.

**Table 11-15. Distance Limitations for the 7410D and 7410 Plus Voice Terminals**

System	Port Board	Nominal Maximum Range in Feet (Meters) (See Note)	
		24 AWG	26 AWG
System 85	SN270B	3,400 (1,034)	2,200 (671)
	TN754	3,400 (1,034)	2,200 (671)
DEFINITY G2	SN270B	3,400 (1,034)	2,200 (671)
	TN754	3,400 (1,034)	2,200 (671)
DEFINITY G1 and G3, DEFINITY ECS, and System 75	TN754	3,400 (1,034)	2,200 (671)

**Note:**

These ranges can be extended to 5,000 feet (1524 m) for 24 AWG wire and 4,000 feet (1219 m) for 26 AWG wire with the use of a Data Link Protector. Refer to the **Exposed Port Protection** section earlier in this manual.

### Power Requirements

The 7410D and 7410 Plus voice terminals receive power from the system and do not require any external power supply. Additional external power is required when the 7410D and 7410 Plus voice terminals are equipped with any adjuncts, such as an external speakerphone. Refer to the **Adjunct Power** section earlier in this manual.

## **Switch Administration**

---

### **Aliasing**

The 7410 voice terminals must be aliased in the following way:

**Table 11-16. Administering the 7410D and 7410 Plus Voice Terminals**

<b>If you are administering this system:</b>	<b>For this type of voice terminal:</b>	<b>The voice terminal must be administered as:</b>
System 75, R1V1, V2, V3, System 85, R2V1, V2, V3, V4 and DEFINITY G1 and G3, and DEFINITY ECS	7410D 7410 Plus	a 7403D voice terminal
DEFINITY G2	7410D	itself
DEFINITY G2	7410 Plus	a 7410D voice terminal

### **Button Numbering**

The following button diagrams of the 7410D and 7410 Plus voice terminals will help you administer both of these voice terminals connected to a System 75, a DEFINITY G1 and G3, or DEFINITY ECS, and to a System 85 or a DEFINITY G2.

In these figures, the button numbers on the 10 administrable call appearance and feature buttons (on both the 7410D and the 7410 Plus voice terminals) correspond to button assignments on Page 2 of the voice terminal administration screen form.

Figures 11-28 and 11-29 show button numbering for the 7410D (7410D01A) voice terminal; Figures 11-30 and 11-31 show button numbering for the 7410 Plus (7410D02A) voice terminal.

If you need more information, refer to *DEFINITY Communications System Generic 3 Implementation*, 555-230-653, and *DEFINITY Communications System Generic 2 Administration of Features and Hardware*, 555-104-507.

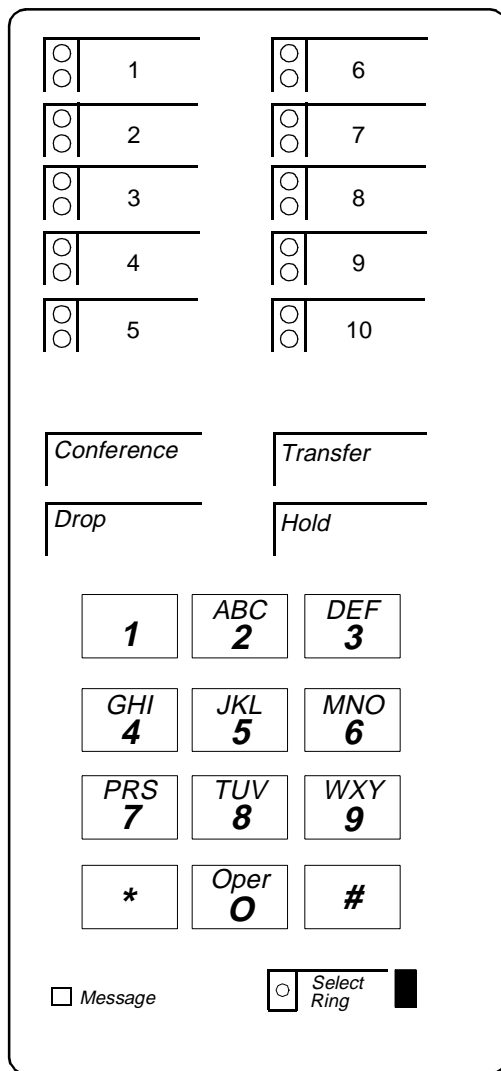
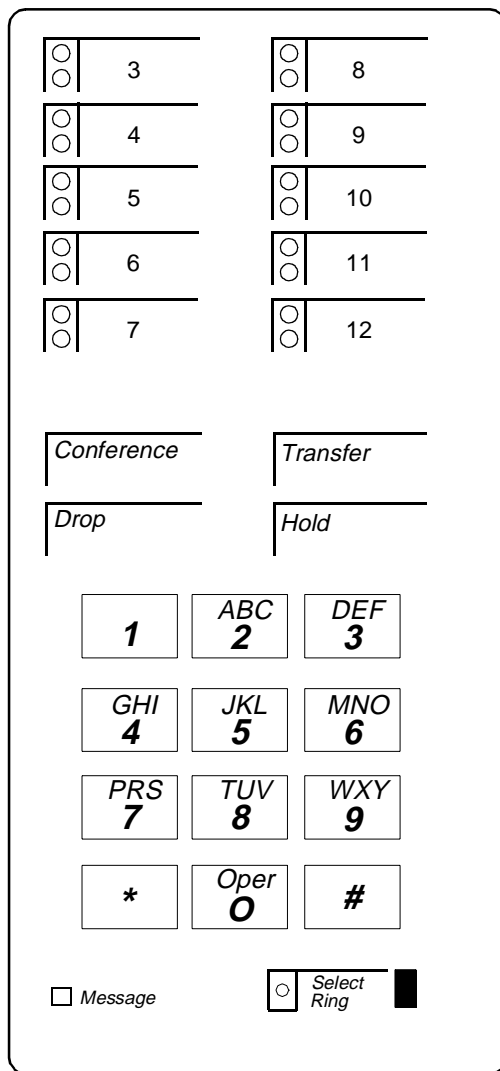

Figure 11-28. Button Numbering for Administering the 7410D Voice Terminal Connected to a System 75, a DEFINITY G1 or G3, or a DEFINITY ECS

11 The 7400 Series Voice Terminals  
The 7410D and 7410 Plus Voice Terminals

11-96



NOTE: The Hold Button is Button #1.  
The Message Light is Button #2.

Figure 11-29. Button Numbering for Administering the 7410D Voice Terminal Connected to a System 85 or a DEFINITY G2



11 The 7400 Series Voice Terminals  
The 7410D and 7410 Plus Voice Terminals

11-97

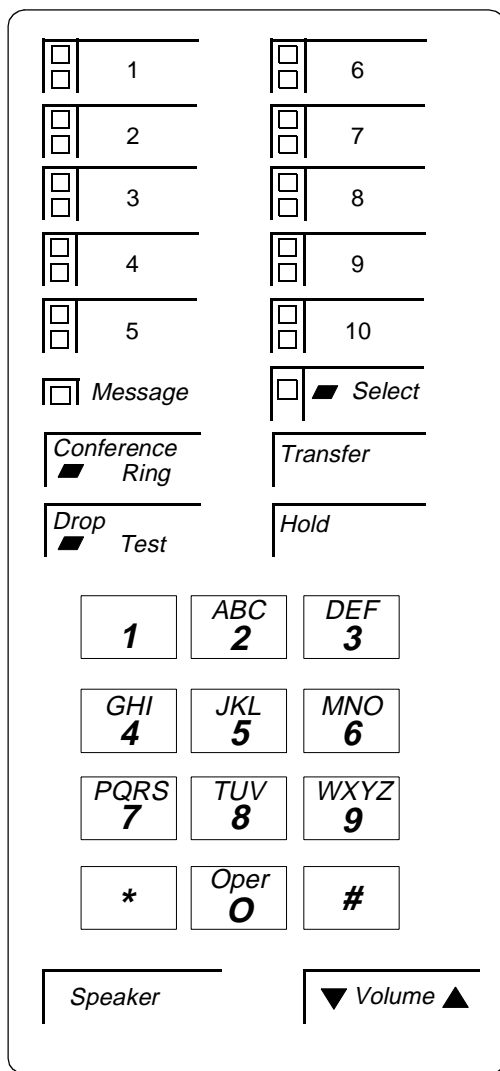
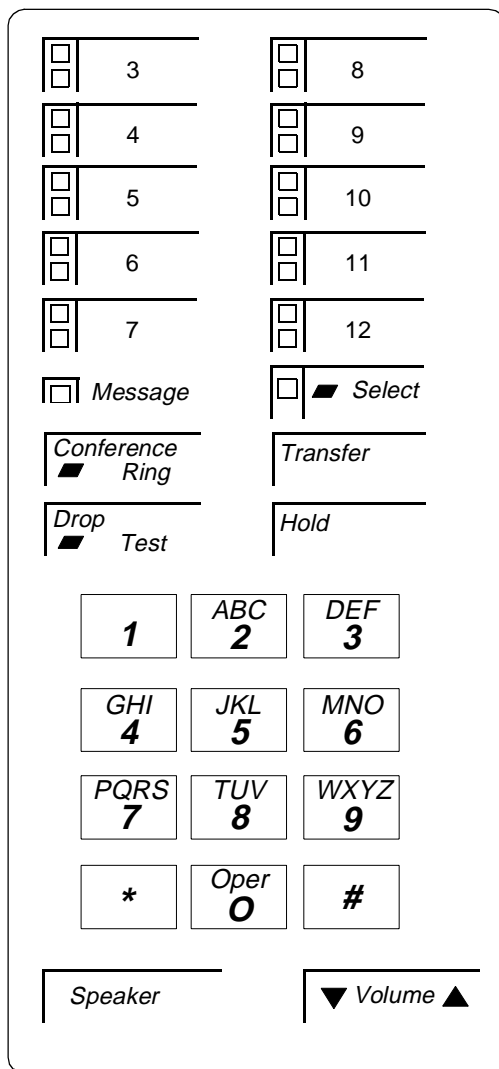

Figure 11-30. Button Numbering for Administering the 7410 Plus Voice Terminal Connected to a System 75, a DEFINITY G1 or G3, or a DEFINITY ECS



NOTE: The Hold Button is Button #1.  
 The Message Light is Button #2.

Figure 11-31. Button Numbering for Administering the 7410 Plus Voice Terminal Connected to a System 85 or a DEFINITY G2

11 The 7400 Series Voice Terminals  
*The 7410D and 7410 Plus Voice Terminals*

11-99

## Power Failure Operation

The 7410D and 7410 Plus voice terminals cannot be used as an emergency station during power failure transfer conditions.

## FCC Registration

These voice terminals are FCC-registered along with the switch (as a system), but do not have a separate FCC registration label.

## UL and CSA Approval

These voice terminals have been tested and have met the Underwriters Laboratories (UL) Standards UL 1459 and have also met the Canadian Standards Association (CSA) Standards CSA-C22.2 No.225-M90.

## Hearing Aid Compatible

These voice terminals are compatible with the inductively coupled hearing aids prescribed by the FCC.

## 7410D Equipment with PECs and Comcodes

The 7410D (7410D01A) voice terminal and components can be ordered with the following PECs and Comcodes:

- **Basic 7410D Voice Terminal**  
PEC: 3186-15D (Black=COL09; Misty Cream=COL22)  
Comcode: Black=105418636; Misty Cream=105418677
- **Handset**  
Comcode: Black=105157291; Misty Cream=105158885
- **Handset cord (9 feet)**  
Comcode: Black=102803327; Misty Cream=104211305
- **Handset cord (12 feet, black)**  
PEC: 2725-01L (Black=COL09; Misty Cream=COL22)  
Comcode: Black=102401445; Misty Cream=104211339
- **Line cord (9 feet)**  
Comcode: 103786778
- **Line cord (14 feet, silver)**  
PEC: 2725-07N (COL18)  
Comcode: 103786802
- **Line cord (25 feet, silver)**  
PEC: 2725-07S (COL18)  
Comcode: 103786828

11 The 7400 Series Voice Terminals  
The 7410D and 7410 Plus Voice Terminals

11-100

- **Graphic panel**  
Comcode: Black=846118016; Misty Cream=846118024
- **Button designation card**  
(Package of 50)  
PEC: 31861  
Comcode: 846131977
- **Desk stand/Wall mount assembly**  
Comcode: 846028546

## 7410 Plus Equipment PECs and Comcodes

The 7410 Plus (7410D02A) voice terminal and components can be ordered with the following PECs and Comcodes:

- **Basic 7410D02A Voice Terminal**  
PEC: 3186-PLS (Black=COL09; Misty Cream=COL22)  
Comcode: Black=106224470; Misty Cream=106224488
- **Handset**  
Comcode: Black=105519086; Misty Cream=105520787
- **Handset cord (9 feet)**  
Comcode: Black=105635429; Misty Cream=105635437
- **Handset cord (12 feet)**  
PEC: 2725-01L (Black=COL09; Misty Cream=COL22)  
Comcode: Black=102401445; Misty Cream=104211339
- **Line Cord (7 feet, silver)**  
Comcode: 103786778
- **Line cord (14 feet, silver)**  
PEC: 2725-07N (COL18)  
Comcode: 103786802
- **Line cord (25 feet, silver)**  
PEC: 2725-07S (COL18)  
Comcode: 103786828
- **Button designation card**  
PEC: 31866 (Package of 50 cards)  
Single sheets Comcode: 846523892  
Pack of 50 Comcode: 846523900  
Tractor feed, 200 Sheets Comcode: 846551448  
Tractor feed, 500 Sheets Comcode: 846551455
- **Faceplate**  
(Package of 50)  
PEC: 31864 (Black=COL09; Misty Cream=COL22)  
Comcode: Black=846551414, Misty Cream=846585677
- **Desk stand/Wall mount assembly**  
Comcode: 846028546

## Adjuncts

---

The following adjuncts can be used with this voice terminal:

- S101A Speakerphone (no longer orderable)
- S201A Speakerphone
- CS201A Speakerphone
- 7400B Data Module
- 500A Headset Adapter (and a standard headset: see “Headsets” below)
- R6 Amplifier Handset (PEC: 3152-002)
- R8 Noisy Location Handset (PEC: 3152-003)
- R2H Standard Handset (PEC: 3152-019)
- Shoulder Rest

## Headsets

A list of compatible headsets, consisting of both modular and plug prong base units and selection of headpieces, appears in “Headset Adapters” in the **Adjuncts** section later in this manual.

## Additional Documents

---

The following documents contain additional information relating to the 7410D and 7410 Plus voice terminals: (Use the 9-digit number listed after each document to order the book from the BCS Publications Center for Lucent Technologies.)

- *7410D Voice Terminal Installation Instructions*, 555-015-102
- *System 75 7410D Voice Terminal User's Guide*, 555-200-732
- *DEFINITY Communications System Generic 1 7410D Voice Terminal User's Guide*, 555-204-727
- *DEFINITY Communications System Generic 2 and System 85 7410D Voice Terminal User's Guide*, 555-104-716
- *DEFINITY Communications System Generic 1 and System 75 7410 Plus Voice Terminal User's Guide*, 555-204-743
- *DEFINITY Communications System Generic 2 and System 85 7410 Plus Voice Terminal User's Guide*, 555-104-743

The following document is shipped with every 7410 Plus voice terminal:

- *7401 Plus and 7410 Plus Voice Terminals Installation Instructions*, 555-015-128

## The 7434D Voice Terminal

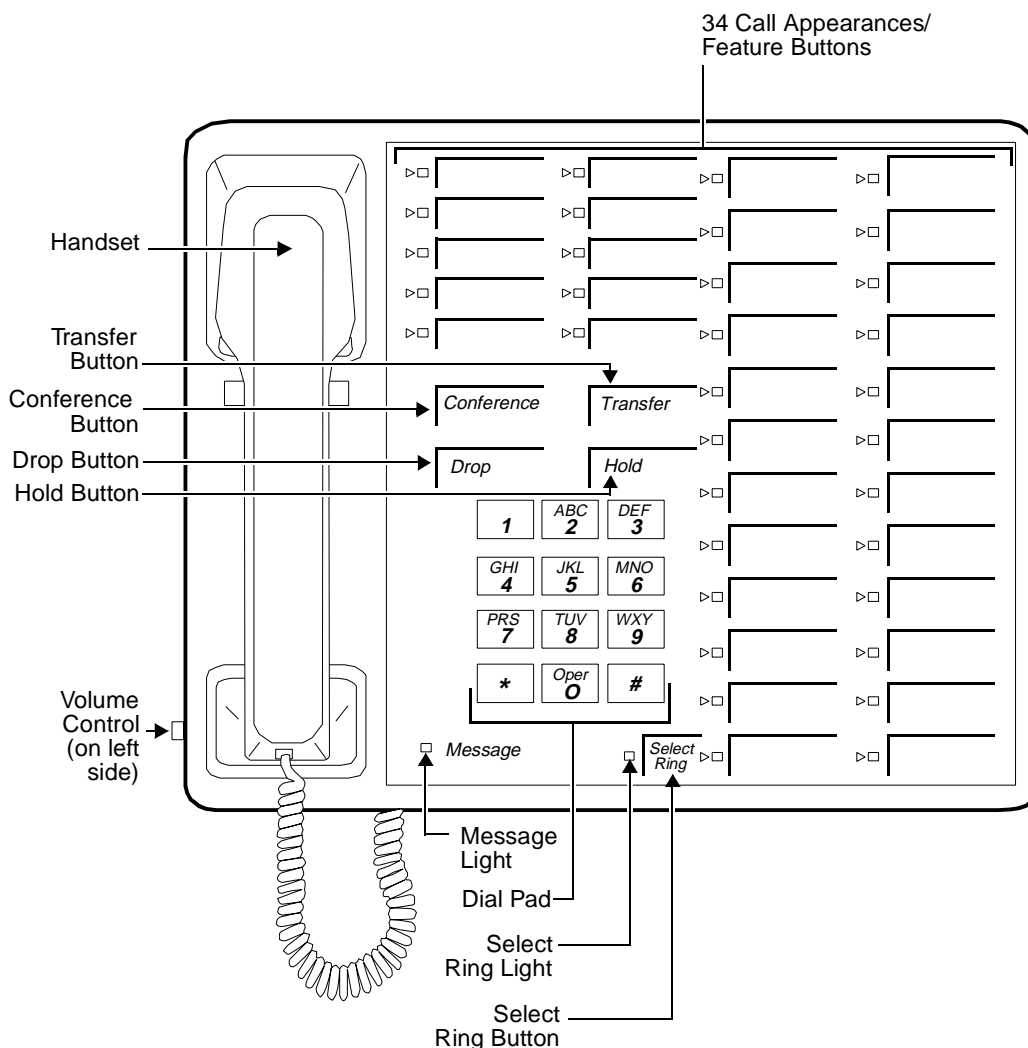

Figure 11-32. The 7434D Voice Terminal

The 7434D is a multi-appearance digital voice terminal. It is an improved descendant of the 7405D, which it resembles physically and functionally. The 7434D voice terminal has more call appearance capacity (DEFINITY G2 only) than the 7405D and is lower in both cost and power consumption. It connects to a digital line port in the system cabinet. The 7434D voice terminal supports an adjunct display module or a call coverage module.

## Applications

---

The 7434D voice terminal can be used with the DEFINITY Communications System Generic 1, Generic 2, and Generic 3, the DEFINITY ECS, System 75, or System 85. It is an appropriate terminal for users who handle numerous calls and who need button access to a wide variety of features. For example, the 7434D voice terminal, with its large number of administrable buttons, can use the Abbreviated Dialing feature for reaching many frequently called parties. The buttons of the 7434D voice terminal can also be assigned for bridging calls at other stations. Typical users are secretaries, managers, salespeople, buyers, answering groups, and call covering positions. The 7434D can provide simultaneous voice and data communications via the PC/PBX connection or 7400B Data Module.

## Physical Description

---

### Dimension



**NOTE:**

The following dimensions for the 7434D voice terminal are approximate.

Width = 10-1/2 inches

Depth (front to back) = 8-3/4 inches

Height (maximum with handset in place) = 6-1/2 inches

Thickness of housing = 1-1/2 inches

### Features

#### Standard Fixed Feature Buttons

- CONFERENCE button
- TRANSFER button
- DROP button
- HOLD button



**NOTE:**

The DISCONNECT and RECALL buttons found on some earlier 7400 Series voice terminals have been removed from the 7434D voice terminal. A RECALL button can be assigned on an administrable button if needed.

- **SELECT RING** button — a special fixed feature button that has two functions:
  - When used with the \* dial pad key, it allows the user to select one of eight personalized ringing patterns for incoming calls.
  - When used with the DROP button, it allows the user to test the lights, ringer, and display module (if installed) of the voice terminal. The Select Ring test function replaces the Self-Test switch found on most other terminals.

 **NOTE:**

The associated Select Ring light goes on steadily when the button is pressed to activate either function. It winks when the user is stepping through the ringing patterns.

### **Administrable Buttons**

The 7434D voice terminal has 34 call appearance/feature buttons (R2V1 and R2V2 only), each equipped with a triangular red light and a square green status light. Usually, at least three of these buttons (the top three in the leftmost column) are administered as call appearances for the terminal's primary extension number, where calls are placed and answered. The rest of the buttons can be used for more call appearances (including bridged appearances of other stations' extensions) and features. Buttons administered for features have only their status lights active.

### **Message light**

The green light goes on when a message is left for the terminal user. It goes off when the user retrieves the message.

## **Other Physical Features**

### **Handset**

The 7434D voice terminal is equipped with an R-type handset.

### **Dial pad**

The 7434D voice terminal is equipped with a 12-button touch-tone dial pad.

### **Jacks**

The 7434D voice terminal housing contains three jacks. The handset cord jack is just under the left front edge of the housing. It is identified by a picture of a handset molded into the plastic. The LINE jack and the OTHER jack (for adjunct connections) are on the bottom center of the housing. The handset contains a jack for the handset cord.



## Cords

Two cords are supplied with the 7434D voice terminal: a coiled 7-foot modular handset cord and a 7-foot modular line cord. Optional longer cords are available: a 12-foot handset cord, 14-foot and 25-foot line cords.

## Ringling

The 7434D voice terminal has electronic tone ringing with patterns that can be selected via the SELECT RING button. The volume control is on the left side of the housing.

## Mounting Options

The 7434D voice terminal comes equipped with a nonadjustable desk stand. A wall mounting kit can be ordered.

## Color Options

The 7434D voice terminal is available in two colors: black with silver faceplate and misty cream with gray faceplate.

## Distance Limitations

---

The maximum allowable distances of a 7434D voice terminal from the DEFINITY G1, G2, G3, DEFINITY ECS, System 75, or System 85 cabinet are shown in the table below.

**Table 11-17. Distance Limitations for the 7434D Voice Terminal**

System	Port Board	Nominal Maximum Range in Feet (Meters) (See Note)	
		24 AWG	26 AWG
System 85	SN270B	3,400 (1,034)	2,200 (671)
	TN754	3,400 (1,034)	2,200 (671)
DEFINITY G2	SN270B	3,400 (1,034)	2,200 (671)
	TN754	3,400 (1,034)	2,200 (671)
DEFINITY G1 and G3, DEFINITY ECS, and System 75	TN754	3,400 (1,034)	2,200 (671)

**Note:**

These ranges can be extended to 5,000 feet (1524 m) for 24 AWG wire and 4,000 feet (1219 m) for 26 AWG wire with the use of a Data Link Protector. Refer to the **Exposed Port Protection** section earlier in this manual.

---

## Power Requirements

---

The 7434D voice terminal is phantom-powered from the system cabinet, or from a local power supply, on the digital pairs of the line wiring. Adjuncts connected to the 7434D voice terminal require auxiliary power and do not impose a drain on the voice terminal supply. Refer to the **Adjunct Power** section earlier in this manual.

## Power Failure Operation

---

The 7434D voice terminal cannot be used as an emergency station during power failure transfer conditions.

## FCC Registration

---

The 7434D voice terminal is not FCC registered.

## Hearing Aid Compatible

---

This voice terminal is compatible with the inductively coupled hearing aids prescribed by the FCC.

## 7434 Equipment PECs

---

The 7434D voice terminal and optional components were ordered with the following PECs:

- Basic 7434D Voice Terminal (black) — 3187-39D MNT03
- Basic 7434D Voice Terminal (black) wall mounted — 3187-39D MNT13
- Basic voice terminal (misty cream) — 3187-39D MNT08
- Basic voice terminal (misty cream) wall mounted — 3187-39D MNT18
- Handset cord (12 feet, black) — 2725-01L COL09
- Handset cord (12 feet, misty cream) — 2725-01L COL20
- Line cord (14 feet, silver) — 2725-07N COL18
- Line cord (25 feet, silver) — 2725-07S COL18

## Adjuncts

---

The following adjuncts can be used with the 7434D voice terminal:

- S101A Speakerphone or 500A Headset Adapter
- S201A Speakerphone or 500A Headset Adapter
- C401A or C401B Call Coverage Module or D401A or D401B Digital Display Module
- 7400B Data Module



### NOTE:

Auxiliary power is required when any adjuncts are added to the basic voice terminal.

## Additional Documents

---

The following documents contain additional information relating to the 7434D voice terminal:

- *7434D Voice Terminal Installation Guide*, 555-015-103
- *DEFINITY Generic 1 7434D Voice Terminal User's Guide*, 555-204-733
- *System 75 7434D Voice Terminal User's Guide*, 555-200-733
- *DEFINITY Generic 2 and System 85 7434D Voice Terminal User's Guide*, 555-104-709
- *DEFINITY Generic 1 and Generic 2, System 75, and System 85 Terminals and Adjuncts Installation and Test*, 555-015-104

# The 7444 Voice Terminal

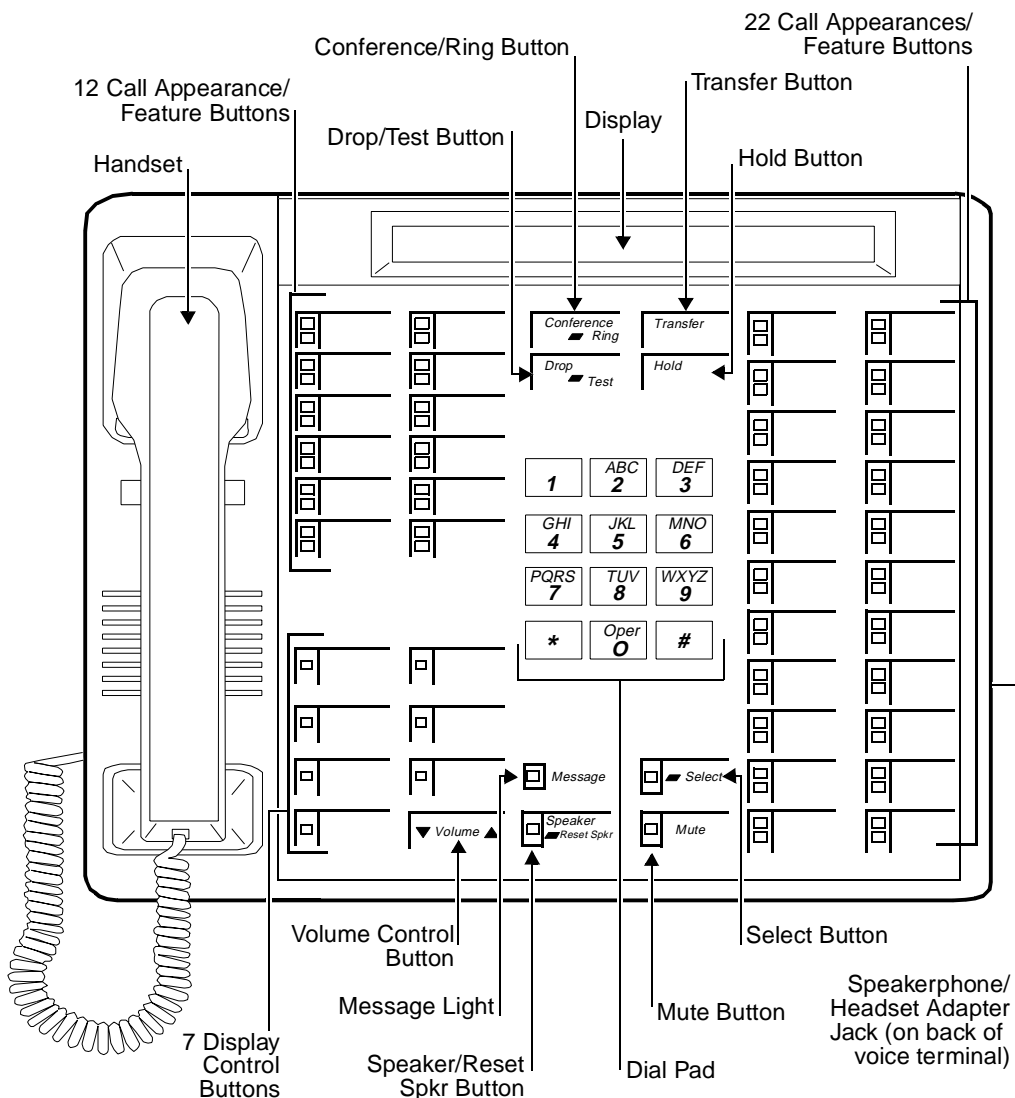

Figure 11-33. The 7444 Voice Terminal

**11** The 7400 Series Voice Terminals  
*The 7444 Voice Terminal*

11-109

The 7444 voice terminal is a multi-appearance digital voice terminal, similar to the 7434 voice terminal. The 7444 voice terminal is a multi-appearance digital voice terminal, similar to the 7434 voice terminal. The 7444 offers 34 call appearance/feature buttons, each with a red in-use light and a green status light, four standard fixed feature buttons (CONFERENCE, DROP, HOLD, and TRANSFER), three fixed feature buttons with one light each (SELECT, SPEAKER/RESET SPKR, and MUTE), seven display feature buttons with one light each, a Message light, personalized ringing, a built-in speakerphone with a reset option, and a built-in 2-line by 40-character vacuum fluorescent display. Data access can be provided by the addition of the PC/PBX Connection Card to any AT&T compatible PC or by use of the 7400B Plus Data Module. This voice terminal connects to a digital line port in the system cabinet and is powered from the switch.

 **NOTE:**

In order to use the display on the 7444 voice terminal, you must connect an auxiliary power supply to the voice terminal. Recommended local power supplies are the 1151A1 or 1151A2 with Battery Holdover or the MSP-1 Power Supply. For information about these power supplies, see the **Adjunct Power** section earlier in this manual.

## Applications

---

The 7444 voice terminal can be used with the DEFINITY Communications System Generic 1, Generic 2, and Generic 3, the DEFINITYECS, System 75, or System 85. It is an appropriate terminal for users who handle numerous calls and who need button access to a wide variety of features. For example, the 7444 voice terminal, with its large number of administrable buttons, can use the Abbreviated Dialing feature for reaching many frequently called parties. The buttons of the 7444 voice terminal can also be assigned for bridging calls at other stations. Typical users are secretaries, managers, salespeople, buyers, answering groups, and call covering positions. The 7444 can provide simultaneous voice and data communications via the PC/PBX connection or 7400B Plus Data Module.

## Physical Description

---

### Dimensions



**NOTE:**

The dimensions given here for the 7444 voice terminal are approximate.

Width = 12 inches

Depth (front to back) = 8-3/4 inches

Height (maximum with handset in place) = 6-1/4 inches

Thickness of housing = 1-1/2 inches

### Features

#### Four Standard Fixed Feature Buttons

- CONFERENCE/RING button
- DROP/TEST button
- TRANSFER button
- HOLD button

#### SELECT button

The SELECT button can be used in three different ways: (The green light next to the SELECT button goes on steadily when the SELECT button is activated.)

- Used with the CONFERENCE/RING button to select one of eight personalized ringing patterns for incoming calls
- Used with the DROP/TEST button to initiate the Self-Test feature which tests the lights, ringer, and display
- Used with the SPEAKER/RESET SPKR button to perform an acoustic test of the environment and adjust the speakerphone to the surrounding acoustic environment for optimal performance

#### Message light

The red Message light goes on when a message is left for the voice terminal user. The light goes off when the user retrieves the message or when the message is erased.

#### Call Appearance/Feature Buttons

The 7444D voice terminal has 34 call appearance/feature buttons, each equipped with a red in-use and a green status light. Usually, at least three of these buttons (the top three in the leftmost column) are administered as call appearances for the

terminal's primary extension number, where calls are placed and answered. The rest of the buttons can be used for more call appearances (including bridged appearances of other stations' extensions) and features. Buttons administered for features have only their status lights active.

### **Seven Display Feature Buttons (with a green status light)**

The 7444 has seven administrable display feature buttons, each with a green status light. These buttons can be used for only display features, such as Inspect.

### **Speakerphone (Listen and Speak) Feature**

The 7444 voice terminal is equipped with a built-in S201A-type speakerphone. The Speakerphone capability allows a user to engage in a hands-free 2-way conversation with the far-end party. The speakerphone can be turned off or on with the SPEAKER/RESET SPKR button, can be muted with the MUTE button, and the volume can be controlled with the VOLUME "arrow" button.

The SPEAKER/RESET SPKR button also allows the user to adjust the speakerphone for optimal performance. By pressing the SELECT button and then the SPEAKER/RESET SPKR button (if the voice terminal is set for the Speakerphone feature), the user hears a set of tones as the speakerphone performs an acoustic test of the environment. When the tones stop, the speakerphone has finished adjusting itself and is ready for use. The user should reset the speakerphone whenever the voice terminal is moved to another place (even in the same room), whenever the green light next to the SPEAKER/RESET SPKR button is fluttering, and in the unlikely event that the speakerphone is making a squealing sound (in this last case, tones will not be heard during a call).

### **Speaker (Listen-only) Feature**

The 7444 voice terminal can be optioned for the Speakerphone (listen and speak) or the Speaker (listen-only) feature. Use the SPEAKER/RESET SPKR button on the front of the voice terminal for turning on and off the speaker or speakerphone.

The voice terminal is shipped with the Speakerphone setting in place, but, the necessary DIP switch setting can be changed so that the voice terminal operates with the Speaker feature instead. In this case, the S2 switch should be set to the ON position, so that the voice terminal will operate with the Speaker (listen-only) feature.

The Speaker (listen-only) capability allows a user to engage in a one-way conversation with the far-end. Specifically, the user can only listen to the far-end; the user is not able to transmit his voice over the speaker. To speak with the far-end, the user must use the handset which turns off the speaker.

### **MUTE button**

The MUTE button disables the transmitter of the speakerphone or the handset depending on which is activated at that time. A red light next to the MUTE button goes on when the Mute feature is activated.

### **VOLUME control button**

The 7444 voice terminal has a VOLUME “arrow” button. This button has a double function. When the user is on a call, the VOLUME button controls the volume of the speaker or speakerphone, whichever is being used; when the user is not using the speaker or speakerphone, the VOLUME control button adjusts the tone ringer.

When the user sets the volume for the speaker or speakerphone or for the tone ringer, the display on the voice terminal shows a “bar array” that indicates the volume setting.

### **Self-Test**

By pressing the SELECT button and then the DROP/TEST button, the user can initiate a test of the lights, ringer, and display on the voice terminal.

### **Display**

The 7444 voice terminal is equipped with a built-in, 2-line, 40-character per line vacuum fluorescent display.

## **Other Physical Features**

### **Handset**

The 7444 voice terminal is equipped with an R-type handset.

### **Dial pad**

The 7444 voice terminal is equipped with a 12-button touch-tone dial pad. The letters “Q” and “Z” have been added to the appropriate dial pad keys for directory access, and the “5” button on your dial pad has raised bars for visually-impaired users.

### **Jacks**

The 7444 voice terminal housing contains a Line jack and Speakerphone/headset adapter jack on the back of the voice terminal and a Handset cord jack just under the left front edge of the housing.

### **Cords**

Two cords are supplied with the 7444 voice terminal: a coiled 9-foot modular handset cord and a 7-foot modular line cord.

Optional longer cords are available: a 12-foot handset cord, 14-foot and 25-foot line cords.



## Ringling

The 7444 voice terminal has electronic tone ringing with eight possible ringing patterns that can be selected with the SELECT button and the CONFERENCE/RING button. The loudness of the tone ringer can be controlled by the VOLUME “arrow” button. (The user must not be on a speakerphone call. If the user is using the speakerphone, the VOLUME “arrow” button controls the volume of the speakerphone.)

## Mounting Options

The 7444 voice terminal comes equipped with a nonadjustable desk stand. This voice terminal cannot be wall-mounted.

## Color Options

The 7444 voice terminal is available in black and misty cream.

## Distance Limitations

The maximum allowable distances of a 7444 voice terminal from the DEFINITY G1, G2, G3, DEFINITY ECS, System 75, or System 85 cabinet are shown in the table below.

**Table 11-18. Distance Limitations for the 7444 Voice Terminal**

System	Port Board	Nominal Maximum Range in Feet (Meters) (See Note)	
		24 AWG	26 AWG
System 85	SN270B	3,400 (1,034)	2,200 (671)
	TN754	3,400 (1,034)	2,200 (671)
DEFINITY G2	SN270B	3,400 (1,034)	2,200 (671)
	TN754	3,400 (1,034)	2,200 (671)
DEFINITY G1 and G3, DEFINITY ECS, and System 75	TN754	3,400 (1,034)	2,200 (671)

**Note:**

These ranges can be extended to 5,000 feet (1524 m) for 24 AWG wire and 4,000 feet (1219 m) for 26 AWG wire with the use of a Data Link Protector. Refer to the **Exposed Port Protection** section earlier in this manual.

## Power Requirements

---

The 7444 voice terminal is phantom-powered from the system cabinet on the digital pairs of the line wiring.

In order to use the display on the 7444 voice terminal, you must connect an auxiliary power source to the voice terminal. Recommended local power supplies are the 1151A1 or 1151A2 with Battery Holdover or the MSP-1 Power Supply.

## Switch Administration

---

### Aliasing

The 7444 voice terminals must be aliased in the following way:

**Table 11-19. Administering the 7444 Voice Terminal**

<b>If you are administering this system:</b>	<b>The 7444 voice terminal must be administered as:</b>
System 75, R1V1	a 7405D voice terminal (with display) (See <b>CAVEATS</b> below)
System 75, R1V2 and R1V3	a 7405D voice terminal (with display) <i>or</i> a 7407D voice terminal (See <b>CAVEATS</b> below)
System 85, R2V1	a 7405D voice terminal (with display) (See <b>CAVEATS</b> below)
System 85, R2V2 through R2V4	a 7405D voice terminal (with display) <i>or</i> a 7407D voice terminal (See <b>CAVEATS</b> below)
DEFINITY G1 and G3, and DEFINITY ECS	a 7434 voice terminal (with display) <i>or</i> a 7407 voice terminal (See <b>CAVEATS</b> below)
DEFINITY G2	a 7434 voice terminal (with display) <i>or</i> a 7407 voice terminal (See <b>CAVEATS</b> below)

### **CAVEATS:**

If the 7444 voice terminal is administered as a 7405D or a 7407D, the following caveats apply:

11 The 7400 Series Voice Terminals  
The 7444 Voice Terminal

11-115

- Only 10 call appearance buttons can be administered with two lights, a red and a green light.
- If the voice terminal is administered as a 7407D, the S1 switch on the back of the 7444 voice terminal must be in the OFF position.

When the 7444 voice terminal is administered as a 7405D or a 7434 voice terminal, the following caveats apply:

- The S1 switch on the back of the 7444 voice terminal must be in the ON position.
- Only one line of the display will show switch-related information.

When a 7444 is administered as a 7434, the DEFINITY G1 and G3 and DEFINITY ECS allows a maximum of 10 appearances of the primary line while the DEFINITY G2 allows a maximum of 12 appearances. Each switch handles appearances of other lines (that is, lines used in Bridging, Call Pickup, etc.) in a different manner. Information about administering these appearances can be found in switch documentation and help screens.

If there is a 7400B or 7400B Plus Data Module attached to the 7444 voice terminal, the voice terminal must be administered with display *and* with data module.

## Button Numbering

The following button diagrams of the 7444 voice terminal will help you administer it with a System 75, a DEFINITY G1 or G3, or DEFINITY ECS and with a System 85 and a DEFINITY G2. Figure 11-34 refers to the 7444 voice terminals connected to a System 75, a DEFINITY G1 or G3, or DEFINITY ECS; Figure 11-35 refers to the 7444 voice terminal connected to a System 85 or a DEFINITY G2.

If you need more information, refer to *DEFINITY Communications System Generic 1 Implementation*, 555-230-653, and *DEFINITY Communications System Generic 2 Administration of Features and Hardware*, 555-104-507.

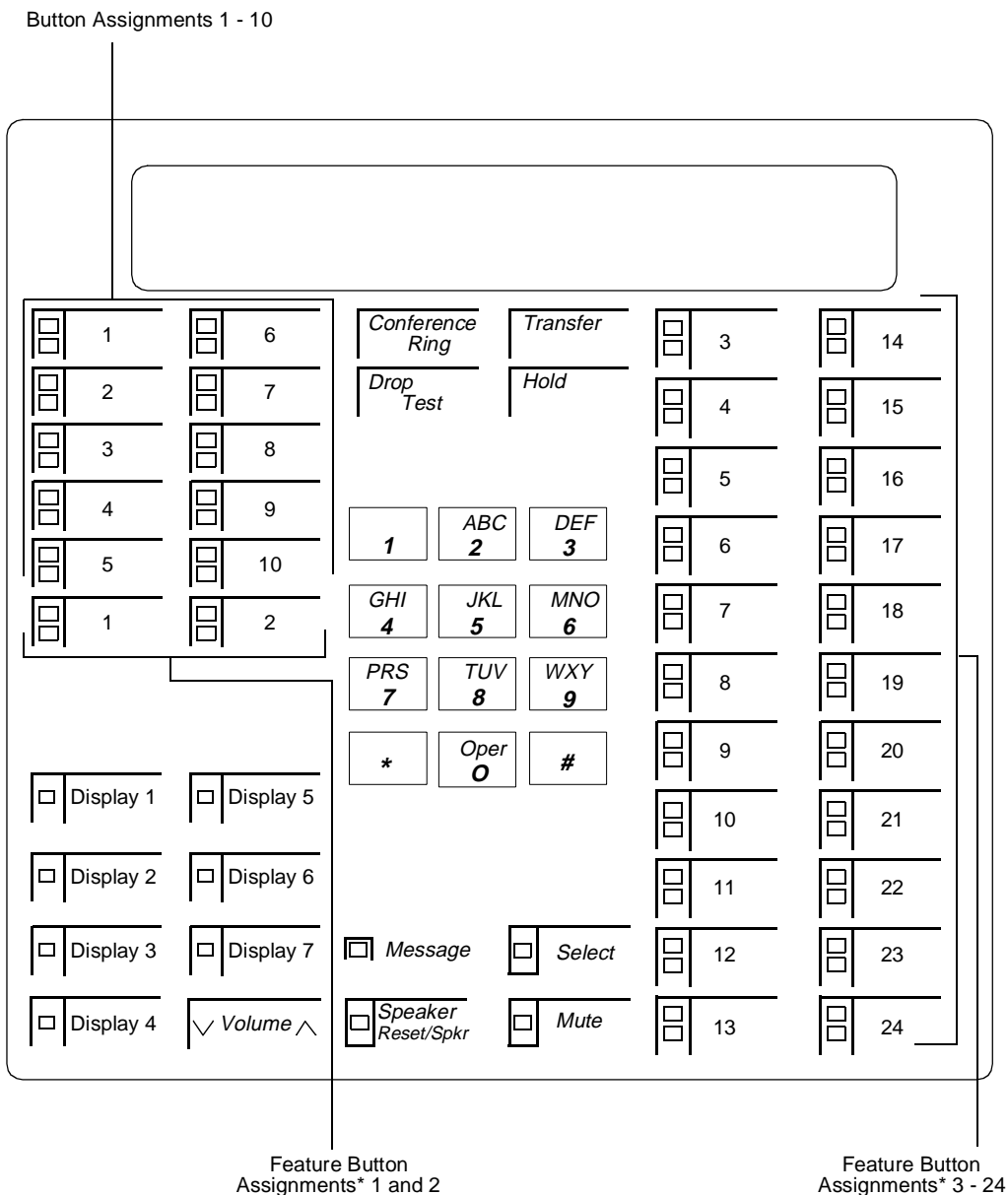

\* If aliased as a 7434, the feature button assignments are numbered 11 - 34

Figure 11-34. Button Numbering for Administering the 7444 Voice Terminal Connected to a System 75, a DEFINITY G1 or G3, or a DEFINITY ECS

Button Assignments 3 - 12

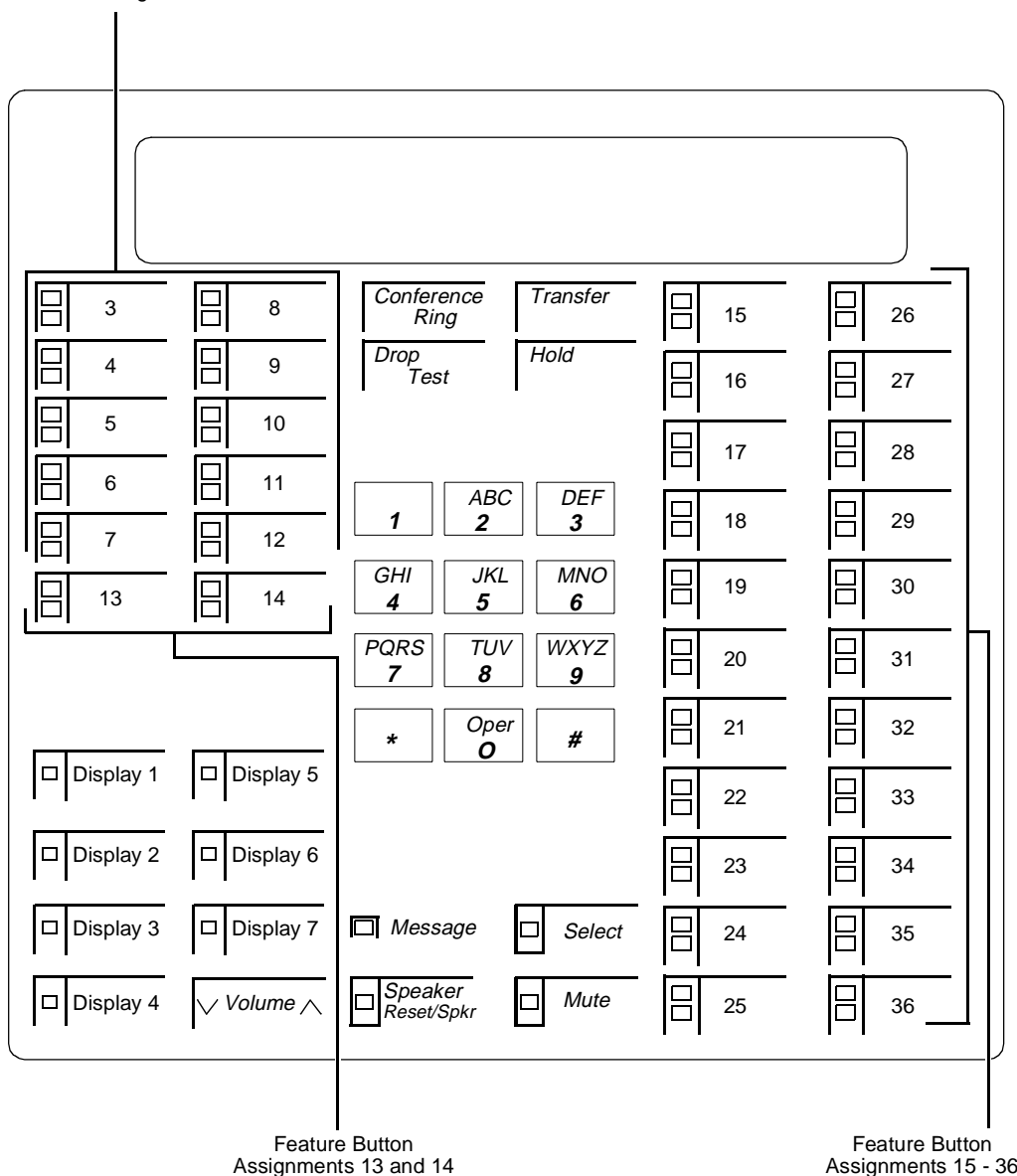

NOTE: The Hold Button is Button #1.  
 The Message Light is Button #2.

Figure 11-35. Button Numbering for Administering the 7444 Voice Terminal Connected to a System 85 or a DEFINITY G2

## Power Failure Operation

The 7444 voice terminal cannot be used as an emergency station during power failure transfer conditions.

## FCC Registration

This voice terminal is FCC-registered along with the switch (as a system), but does not have a separate FCC registration label.

## UL and CSA Approval

This voice terminal has been tested and has met the Underwriters Laboratories (UL) Standards UL 1459 and have also met the Canadian Standards Association (CSA) Standards CSA-C22.2 No.225-M90.

## Hearing Aid Compatible

This voice terminal is compatible with the inductively coupled hearing aids prescribed by the FCC.

## 7444 Equipment PECs and Comcodes

The 7444D voice terminal and optional components can be ordered with the following PECs and Comcodes:

- **Basic 7444 Voice Terminal**  
PEC: 3187-VFD (Black=COL09; Misty Cream=COL22)  
Comcode: Black=106200579; Misty Cream=106200587
- **Handset**  
Comcode: Black=105519086; Misty Cream=105520787
- **Handset cord (9 feet)**  
Comcode: Black=105635429; Misty Cream=105635437
- **Handset cord (12 feet)**  
PEC: 2725-01L (Black=COL09; Misty Cream=COL22)  
Comcode: Black=102401445; Misty Cream=104211339
- **Line Cord (7 feet)**  
Comcode: 103786778
- **Line cord (14 feet, silver)**  
PEC: 2725-07N COL18  
Comcode: 103786802
- **Line cord (25 feet, silver)**  
PEC: 2725-07S COL18  
Comcode: 103786828

11 The 7400 Series Voice Terminals  
The 7444 Voice Terminal

11-119

- **Button designation card**

PEC: 81005 (Package of 25)

Single, Comcode: Black=846604759; Misty Cream=846604767

Pack of 25 Sheets Comcode: Black=846692341;

Misty Cream=846692358

Tractor Feed, 200 Sheets Comcode: Black=846604775;

Misty Cream=846604783

## Adjuncts

---

The following adjuncts can be used with the 7444 voice terminal:



**NOTE:**

Auxiliary power is required when any adjuncts are added to the basic voice terminal, except for the 7400B Plus Data Module which is AC powered. An MSP-1 Power Supply is recommended.

- S101A Speakerphone (no longer orderable)
- S201A Speakerphone
- CS201A Speakerphone
- 7400B Plus Data Module
- 500A Headset Adapter (and a standard headset; see "Headsets" below)
- Shoulder Rest

## Headsets

A list of compatible headsets, consisting of both modular and plug prong base units and selection of headpieces, appears in "Headset Adapters" in the **Adjuncts** section later in this manual.

## Additional Documents

---

The following documents contain additional information relating to the 7444 voice terminal: (Use the 9-digit number listed after each document to order the book from the BCS Publications Center for Lucent Technologies.)

- *DEFINITY Communications System Generic 1 and System 75 7444 Voice Terminal User's Guide*, 555-204-744
- *DEFINITY Communications System Generic 2 and System 85 7444 Voice Terminal User's Guide*, 555-104-744

The following instructions are shipped with every 7444 voice terminal:

- *7407 Plus and 7444 Voice Terminals Installation Instructions*, 555-015-129

**11** The 7400 Series Voice Terminals  
    *The 7444 Voice Terminal*

11-120



## The 8400 Series Voice Terminals

# 12

---

The following 8400 Series voice terminals are described in this section:

- 8403 voice terminal
- 8405 voice terminal
- 8410 voice terminal
- 8411 voice terminal
- 8434 and 8434DX voice terminals

# The 8403 Voice Terminal

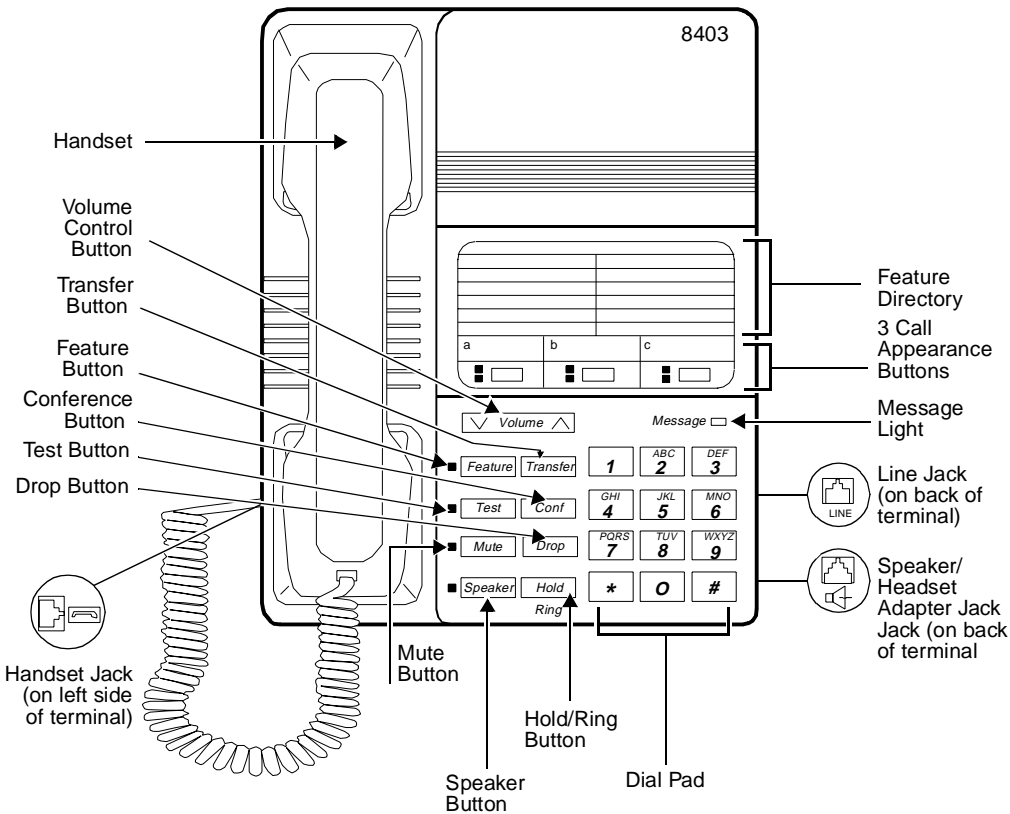

Figure 12-1. One Version of the 8403 Voice Terminal

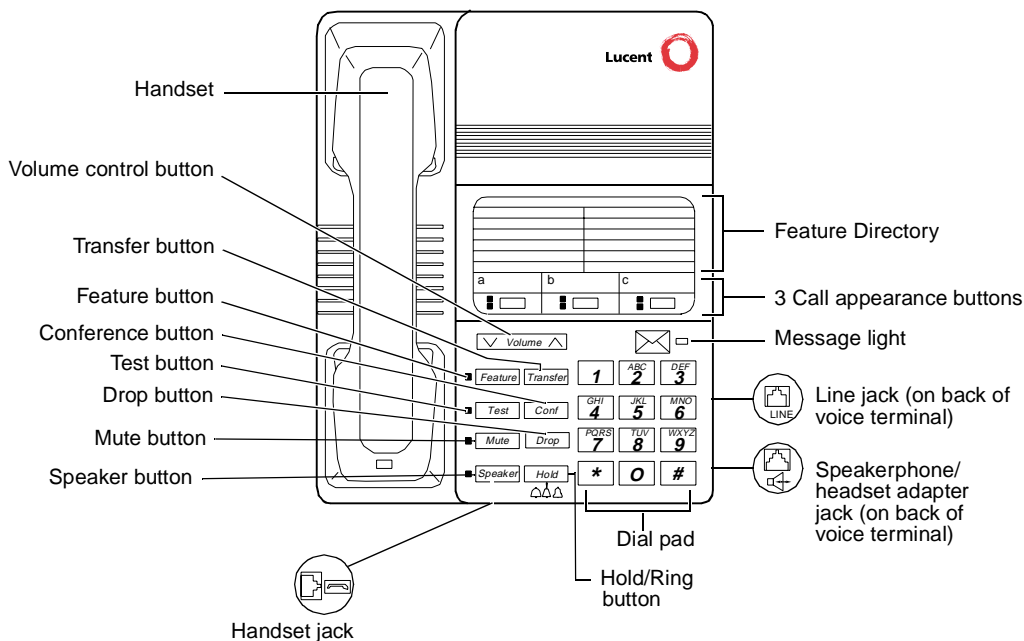

Figure 12-2. Another Version of the 8403 Voice Terminal

The 8403 voice terminal is a multi-appearance digital telephone with three call appearance buttons, Conference, Transfer, Drop, and Hold buttons, a TEST button, a blue FEATURE button which allows you to access 12 system features assigned by the System Manager and to choose from among eight different ringing patterns, a MUTE button, a SPEAKER button which accesses a 1-way, listen-only speaker, a red Message light, and a Volume control button.

The 8403 can be used in either a 4-wire or 2-wire environment. For more information, see the section on "Wiring Information."

## Applications

The 8403 voice terminal can be used with the DEFINITY Communications System Generic 1, Generic 2, and Generic 3, the DEFINITY ECS, System 75, and System 85. This voice terminal is especially suitable for general office workers with low call volumes, manufacturing, warehousing, guard and/or reception areas, or office desks.

The 8403 voice terminal can also provide simultaneous voice and data communications with the 7400B Plus Data Module. PC platform products can also be useful in providing voice capabilities since these screen-based products can greatly enhance the telephone capabilities of these basic voice terminals.

## Physical Features

---

### Dimensions



**NOTE:**

The dimensions described here for the 8403 voice terminal are approximate.

Width = 7-3/4 inches

Depth (front to back) = 9-7/16 inches

Height (maximum with handset in place) = 5-1/2 inches

Thickness of housing = 1-1/2 inches

### Features

#### Eight Fixed Feature Buttons

The 8403 has the following eight fixed feature buttons:

- CONFERENCE button (labeled CONF)
- DROP button
- TRANSFER button
- A red HOLD button
- A blue FEATURE button
- MUTE button
- SPEAKER button
- TEST button

#### The Feature Button

The blue FEATURE button allows the dial pad to serve as 12 feature buttons without indicators. These features are accessed by pressing the FEATURE button and then one of the 12 dial pad keys. The Feature Directory on the faceplate on the top of the telephone lists the features administered at **F1** through **F9**, **F\***, **F0**, and **F#**.

The FEATURE button can also be used with the HOLD button to select your own personalized ringing pattern from among eight available patterns.

#### Feature Directory

The 8403 voice terminal has a Feature Directory card, which has space for 12 features assigned by the System Manager. These features are labeled **F1** through **F9**, **F\***, **F0**, and **F#**.

## Call Appearance Buttons

The 8403 voice terminal has three call appearance buttons. Each of the buttons has a red light and a green status light.

## Message Light

The red Message light goes on when a message is left for the user. It goes off when the user retrieves the message or when the message is erased. This light is labeled either *Message* or .

## SPEAKER Button

The 8403 voice terminal is set for the 1-way, listen-only Speaker feature. The user can only listen to the far-end. To speak with the other party, the user must use the handset which turns off the speaker.

## MUTE button

The MUTE button is a fixed feature button with a red status light. The MUTE button turns off the microphone of the handset so that a person can converse with another person in the room without the other party listening in.

## VOLUME Control button

The 8403 voice terminal has a VOLUME "arrow" button on the front of the set. This button has several functions. When the user is using the 1-way speaker, the VOLUME button controls the volume of the speaker. When the user is on a call using the handset, the VOLUME button controls the volume of the handset. When the voice terminal is idle, the button controls the volume of the tone ringer.

## TEST Button

When the voice terminal is initially powered up, the green light next to the TEST button flashes if the link with the PBX is not (or not yet) operational. The light changes to steady green when the voice terminal is able to communicate with the PBX. After the voice terminal is powered up, you can press the TEST button to test the lights on your voice terminal.

## Other Physical Features

### Handset

The 8403 voice terminal is equipped with a K-type handset.

### Dial pad

The 8403 voice terminal is equipped with a 12-button touch-tone dial pad. The letters "Q" and "Z" have been added to the appropriate dial pad keys for directory access, and the "5" button on the dial pad has raised bars for visually-impaired users.

## Jacks

The 8403 voice terminal's housing has a Line jack and a Handset cord jack located on the back of the housing. There is also a Speakerphone/headset adapter jack on the back of the set to which the user can connect adjunct equipment.

## Cords

Two cords are supplied with the 8403: a coiled 9-foot handset cord and a 7-foot line cord.

Optional longer cords are available: a 12-foot handset cord and 14-foot and 25-foot line cords.

## Ringling

The 8403 voice terminal has electronic tone ringing. With the Select Ring feature, the user can choose any one of eight different ringing patterns. The set has a Volume control button which controls the loudness of the ringer, the speaker, and the handset.

## Mounting Options

The 8403 voice terminal comes equipped with a nonadjustable desk stand. However, the user may choose to remove the stand and then mount the voice terminal on the wall.

## Color Options

The 8403 voice terminal is available in black and in white.

## Wiring Information

---

The 8403 voice terminal works in both 4-wire and 2-wire DCP configurations. The table below describes the pins on an 8400-Series voice terminal LINE jack.

**Table 12-1. The Pins on an 8400-Series Voice Terminal LINE Jack**

Line Interface			
Pin	Pair	Name	Description
1	2	OD1	4-Wire Output
2	2	OD2	4-Wire Output
3	3	ID1	4-Wire Input
4	1	U-T	2-Wire (Tip)
5	1	U-R	2-Wire (Ring)

**Table 12-1. The Pins on an 8400-Series Voice Terminal LINE Jack**

Line Interface			
Pin	Pair	Name	Description
6	3	ID2	4-Wire Input
7	4	P1-	Adjunct Power -48V
8	4	P2+	Adjunct Power Common

**⇒ NOTE:**

Regardless of which configuration is in use, ALL wiring between the PBX and the terminal MUST consist of twisted-pairs, including the modular line cord. The line cord must be a D8W, which consists of 4 twisted-pairs, or a Lucent Technologies-approved equivalent.

Twisted-pair wiring is used to make lines less sensitive to crosstalk. Therefore, failure to use twisted pair wiring may result in less-than-optimum performance of the terminal and may also contribute to problems with the line.

An 8-wire modular cord MUST be used for all 4-wire and any 2-wire installations requiring auxiliary power.

**⇒ NOTE:**

You do NOT need to change any settings on the voice terminal for 2-wire or 4-wire installations. The voice terminal is able to detect whether it is in a 2-wire or a 4-wire configuration.

For 2-wire operation, if you need to plug the voice terminal into a 4-pin or 6-pin wall jack, instead of a standard 8-pin modular jack, refer to the "Line Interface" table to insure that the wires from the 4-pin or 6-pin wall jack are connected to the correct pins on the terminal "LINE" jack.

In order for the terminal to function properly in either 2-wire or 4-wire installations, there must be NO INTERCONNECTIONS between the wire pairs used for 2-wire and 4-wire operations. Bridging or paralleling of these pairs can result in damage to the terminal or can cause the PBX circuit pack to remove power to the terminal.

**REMOVE ALL CONNECTIONS BETWEEN PAIRS BEFORE CONNECTING THE TERMINAL.**

4-WIRE installations MUST ONLY have PBX connections on pair 2 and pair 3 and, if necessary, auxiliary power must be connected to pair 4.

2-WIRE installations MUST ONLY have PBX connections on pair 1 and, if necessary, auxiliary power must be connected to pair 4.

## Distance Limitations

---

The following circuit packs can be used with all of the 8400-Series sets.

**Table 12-2. Distance Limitations for the 8403 Voice Terminal**

Circuit Pack	2/4-Wire	Will support these switches
TN2181 - 16-port	2-wire	G3V3, G3V2
TN754b - 8-port	4-wire	All switches except System 85
TN754 - 8-port	4-wire	All switches except System 85
TN413 - 8-port	4-wire	International System 75
SN 270 and SN270B - 4-port	4-wire	System 85 R2V2 - R2V4

---

**In 4-wire operation**, the voice terminal must be within 5,000 feet of the PBX using 22-gauge or 24-gauge wire, and within 4,000 feet of the PBX using 26-gauge wire.

**In 2-wire operation**, the voice terminal must be within 5,500 feet of the PBX using 22-gauge wire, within 3,500 feet of the PBX using 24-gauge wire, and within 2,200 feet of the PBX using 26-gauge wire.

## Power Requirements

---

The 8403 voice terminal receives power from the system and does not require any external power supply. Additional external power IS required when the 8403 voice terminal is equipped with any adjuncts, such as an external speakerphone. In this instance, an 1151A1 local power supply or an 1151A2 power supply with Battery Holdover is recommended. Refer to the **Adjunct Power** section earlier in this manual for more information about these power supplies.



## Switch Administration

---

### Aliasing

Use the following table for administering the 8403 voice terminal:

**Table 12-3. Administering the 8403 Voice Terminal**

If you have this System	and this Release	(which can support this type of operation)	Administer the 8403 as a
System 75	R1V1 — R1V3	4-wire only	7405
System 85	R2V2 — R2V4	4-wire only	7405
International System 75	IR1V4, etc.	4-wire only	7405
DEFINITY G1		4-wire only	7405
Global DEFINITY' 91		4-wire only	7405
DEFINITY G2V1		4-wire only	7405
DEFINITY G2V2		4-wire only	7405
DEFINITY G3i, G3r, G3s, G3vs		4-wire only	7405
DEFINITY G3V2		2- or 4-wire	7405
DEFINITY G3V3 and later		2- or 4-wire	8403

### Button Numbering

The following button diagrams of the 8403 voice terminal will help you administer both of these voice terminals connected to a System 75, a DEFINITY G1 and G3, or a DEFINITY ECS, and to a System 85 or a DEFINITY G2.

Figure 12-3 shows button numbering for the 8403 connected to a System 75, DEFINITY G1 and G3, or a DEFINITY ECS. Figure 12-4 shows button numbering for the 8403 connected to a System 85 or DEFINITY G2.

If you need more information, refer to *DEFINITY Communications System Generic 3 Implementation*, 555-230-653, and *DEFINITY Communications System Generic 2 Administration of Features and Hardware*, 555-104-507.

If administered as a 7405D, F1 through F7 are administered as "BUTTON ASSIGNMENTS" 4 through 10. F8, F9, F\*, F0, and F# are administered as "FEATURE BUTTON ASSIGNMENTS" 1 through 5.

If administered as itself, administer F1 through F9, F\*, F0, and F# as "FEATURE BUTTON ASSIGNMENTS" 1 through 12.

Call appearance buttons a, b, and c are administered as call appearance "BUTTON ASSIGNMENTS" 1, 2, and 3.

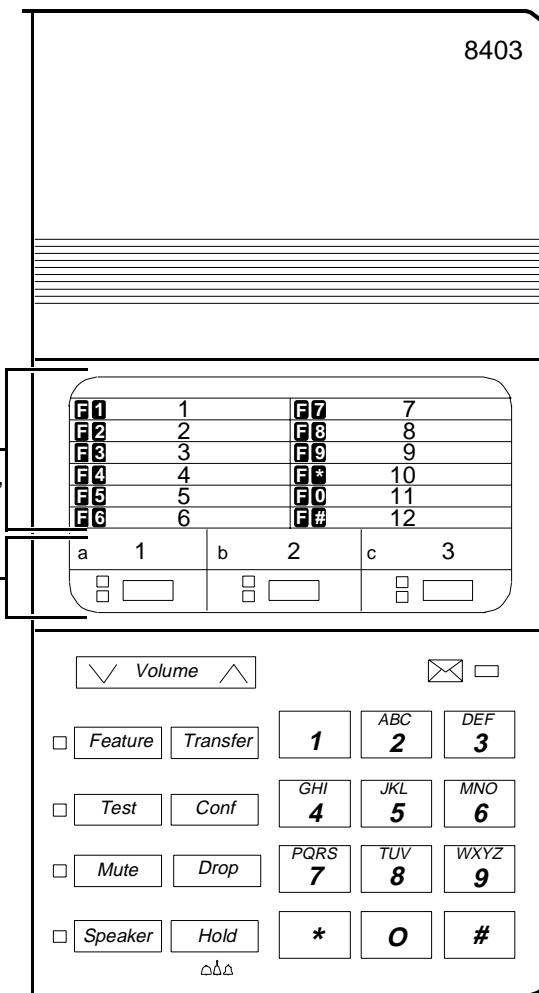

Figure 12-3. Button Numbering for Administering the 8403 Voice Terminal Connected to a System 75, DEFINITY G1 or G3, or DEFINITY ECS

If administered as a 7405D, F1 through F7 are administered as "BUTTON ASSIGNMENTS" 6 through 12. F8, F9, F\*, F0, and F# are administered as "FEATURE BUTTON ASSIGNMENTS" 13 through 17.

If administered as itself, administer F1 through F9, F\*, F0, and F# as "FEATURE BUTTON ASSIGNMENTS" 1 through 12.

Call appearance buttons a, b, and c are administered as call appearance "BUTTON ASSIGNMENTS" 3, 4, and 5.

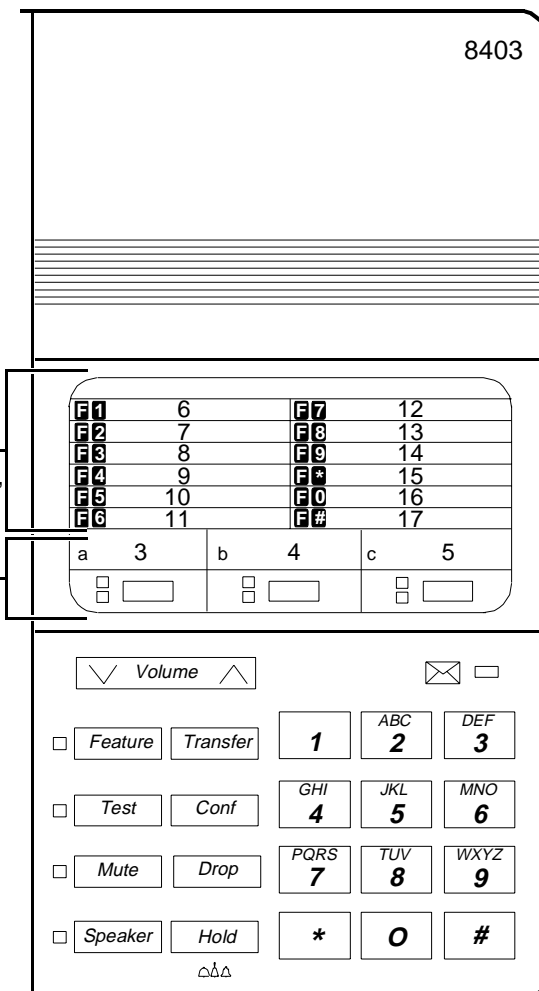

Figure 12-4. Button Numbering for Administering the 8403 Voice Terminal Connected to a System 85 or a DEFINITY G2

### Power Failure Operation

The 8403 voice terminal cannot be used as an emergency station during power failure transfer conditions.

## FCC Registration

The 8403 voice terminal is FCC-registered along with the switch (as a system), but does not have a separate FCC registration label.

## UL and CSA Approval

This voice terminal has been tested and has met the Underwriters Laboratories (UL) Standards UL 1459 and has also met the Canadian Standards Association (CSA) Standards CSA-C22.2 No.225-M90.

## Hearing Aid Compatible

This voice terminal is compatible with the inductively coupled hearing aids prescribed by the FCC.

## 8403 Equipment PECs and Comcodes

The 8403 (8403D01A) voice terminal and components can be ordered with these PECs and Comcodes:

- **Basic 8403 (8403D02A) Voice Terminal**  
Black 8403 Set PEC: 3233-03B  
Comcode: 107702144;  
White 8403 Set PEC: 3233-03W  
Comcode: 107702177
- **K2S8 Handset**  
Comcode: Black=107545584; White=107545568
- **Handset cord (9 feet)**  
Comcode: Black=407632819; White=407632835
- **Line cord (7 feet)**  
Comcode: 103786778
- **Line cord (14 feet, silver)**  
PEC: 2725-07N (COL18)  
Comcode: 103786828
- **Line cord (25 feet, silver)**  
PEC: 2725-07S (COL18)  
Comcode: 103786802
- **Designation Card Cover**  
PEC: 32306  
Comcode: 846506780

12 The 8400 Series Voice Terminals  
The 8403 Voice Terminal

12-13

■ **Button Designation Cards**

Tractor Feed For 25 Sets, 5 Sheets

PEC: 32307

Comcode: 847167962

Tractor Feed, For 100 Sets, 20 Sheets

PEC: 32308

Comcode: 847167970

## Adjuncts

---

The following adjuncts can be used with the 8403 voice terminal:

- S101A Speakerphone (no longer orderable)
- S201A Speakerphone
- CS201A Speakerphone
- 7400B Plus Data Module
- 500A Headset Adapter (and a standard headset; see “Headsets” below)
- K6S2 Amplifier Handset
- Shoulder Rest

## Headsets

A list of compatible headsets, consisting of both modular and plug prong base units and selection of headpieces, appears in “Headset Adapters” in the **Adjuncts** section later in this manual.

## Additional Documents

---

The following documents contain additional information relating to the 8403 voice terminal: (Use the 9 digit number listed after each document to order that book from the BCS Publications Center for Lucent Technologies.)

- *8403, 8410, and 8434 Voice Terminals Instructions for Installation, Switch Administration, and Programming the Options*, 555-015-164
- *DEFINITY Communications System Generic 1 and 3 and System 75 8403 Voice Terminal User's Guide*, 555-230-761
- *DEFINITY Communications System Generic 1 and 3 and System 75 8403 Voice Terminal Quick Reference Guide*, 555-230-762
- *DEFINITY Communications System Generic 2 and System 85 8403 Voice Terminal User's Guide*, 555-104-761
- *DEFINITY Communications System Generic 2 and System 85 8403 Voice Terminal Quick Reference Guide*, 555-104-762

12 The 8400 Series Voice Terminals

The 8405B, 8405B Plus, 8405D, and 8405D Plus Voice Terminals

12-14

# The 8405B, 8405B Plus, 8405D, and 8405D Plus Voice Terminals

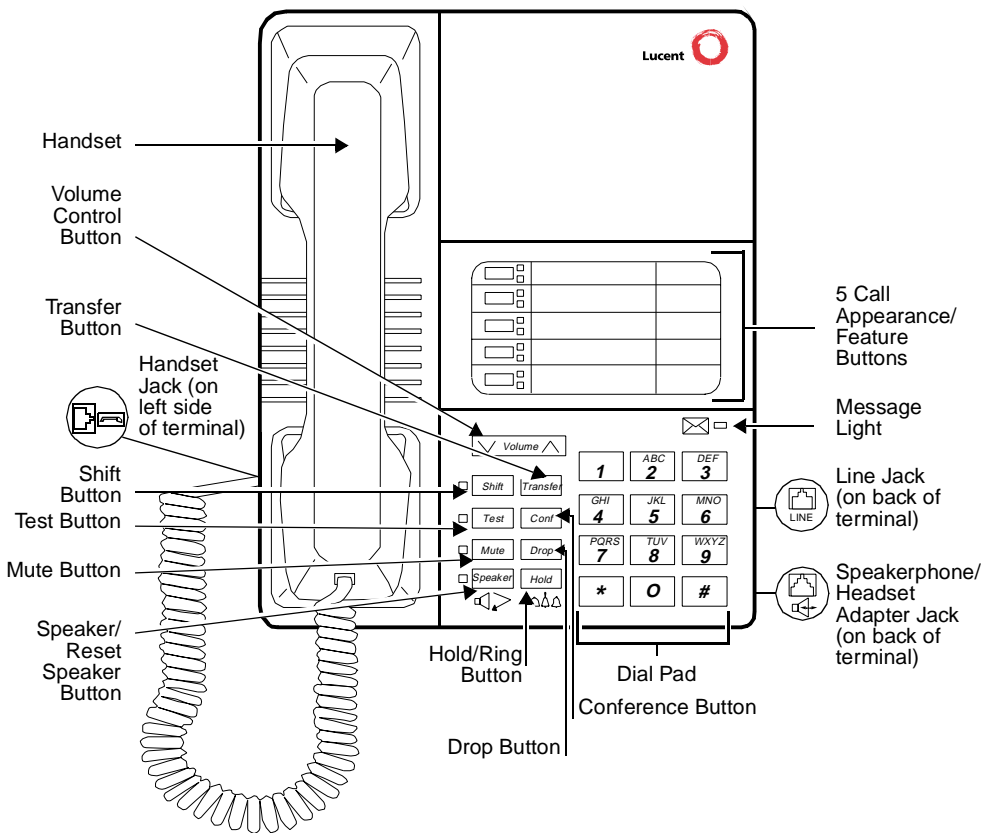

Figure 12-5. One Version of the 8405B and 8405B Plus Voice Terminals

12 The 8400 Series Voice Terminals

The 8405B, 8405B Plus, 8405D, and 8405D Plus Voice Terminals

12-15

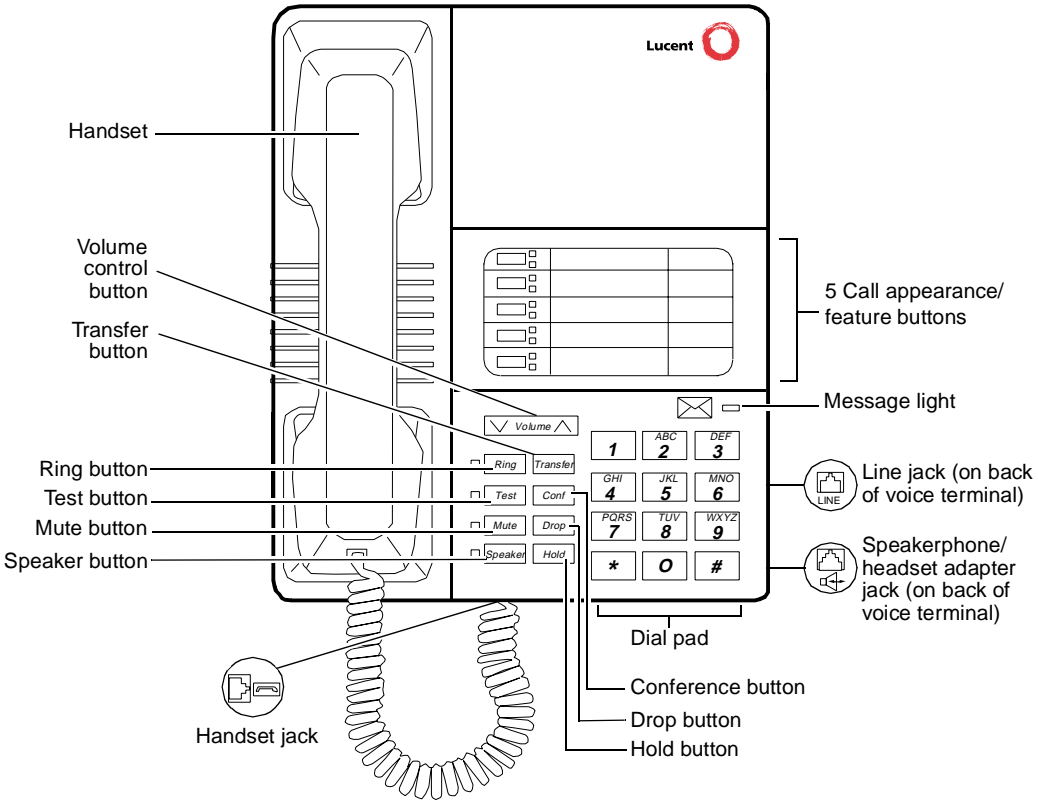

Figure 12-6. Another Version of the 8405B and 8405B Plus Voice Terminals

12 The 8400 Series Voice Terminals

The 8405B, 8405B Plus, 8405D, and 8405D Plus Voice Terminals

12-16

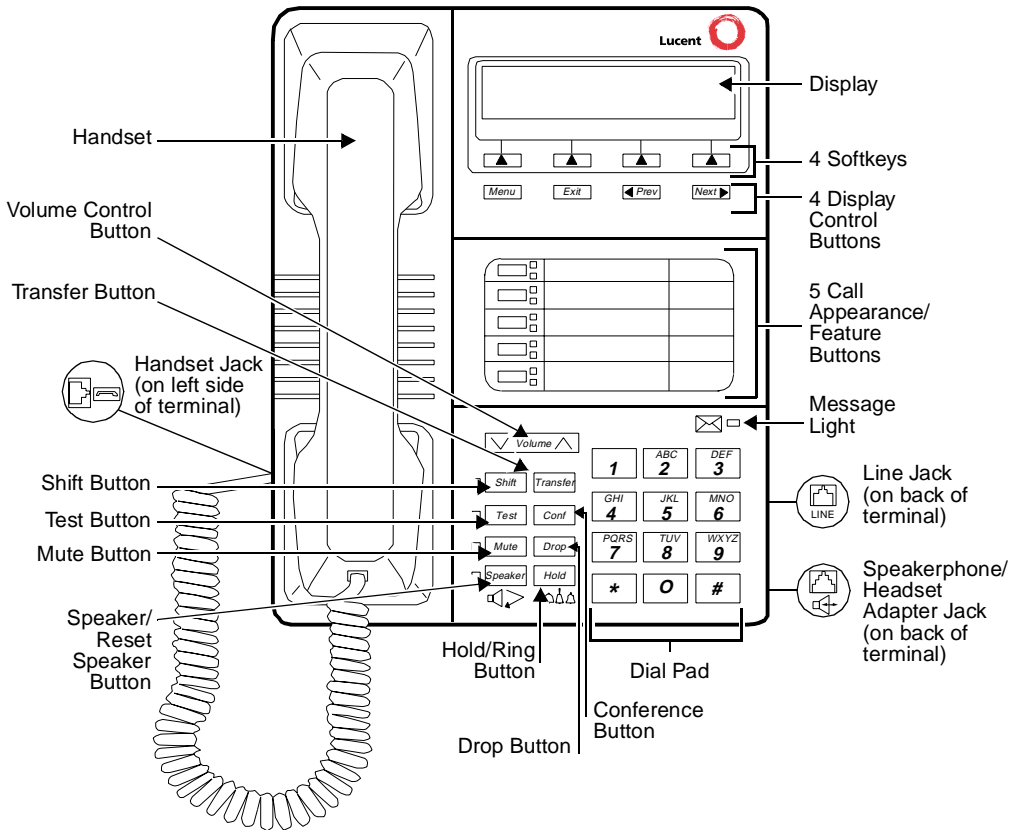

Figure 12-7. One Version of the 8405D and 8405D Plus Voice Terminal (With Display)



12 The 8400 Series Voice Terminals

The 8405B, 8405B Plus, 8405D, and 8405D Plus Voice Terminals

12-17

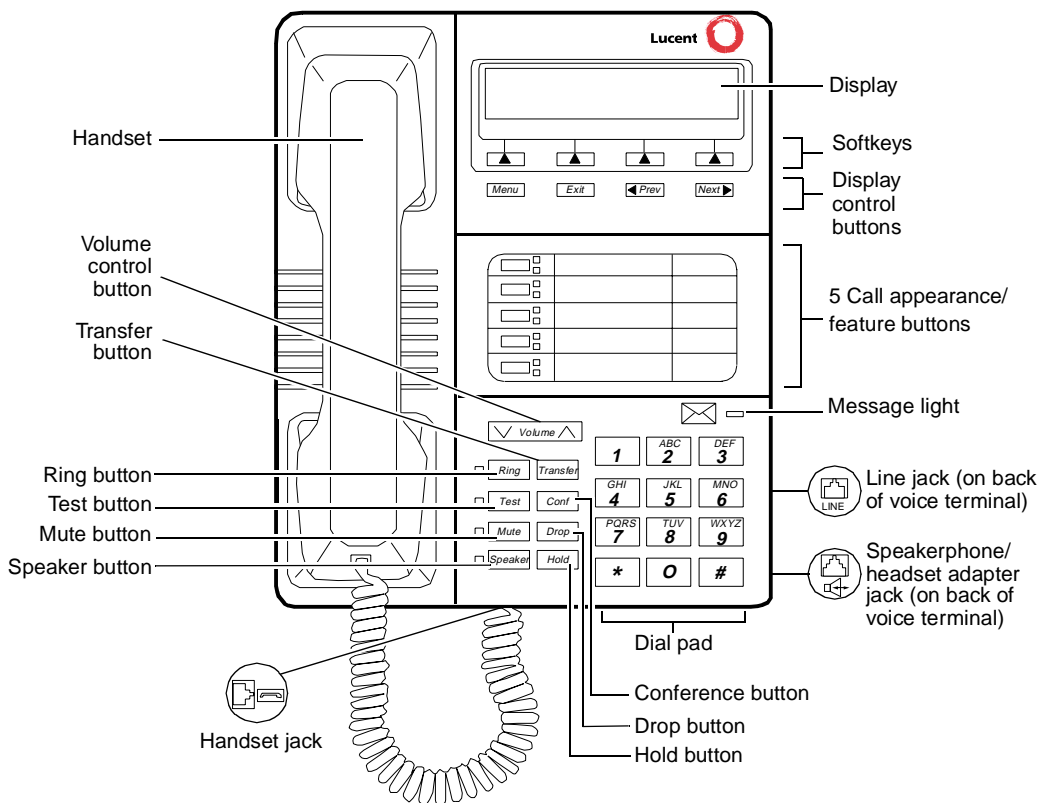

Figure 12-8. Another Version of the 8405D and 8405D Plus

There are four varieties of the 8405 voice terminal: the 8405B and 8405B Plus, the 8405D and 8405D Plus. All four varieties are multi-appearance digital telephones with five call appearance/feature buttons. All of the 8405 voice terminals also have four standard fixed feature buttons (CONFERENCE, DROP, HOLD, and TRANSFER), a MUTE button, a SPEAKER button, a TEST button, and a Volume control button. In addition, some 8405 voice terminals have a blue SHIFT button; others have a RING button instead.

However, these four 8405 variations have the following differences:

- The 8405B has a 1-way, listen-only speaker, with NO display.
- The 8405B Plus has a 2-way speakerphone, without a display.
- The 8405D has a 1-way, listen-only speaker and a 2-line by 24-character display.
- The 8405D Plus has a 2-way speakerphone and a 2-line by 24-character display.

**12** The 8400 Series Voice Terminals

*The 8405B, 8405B Plus, 8405D, and 8405D Plus Voice Terminals*

12-18

Those users who have an 8405D or an 8405D Plus can access 12 features with the softkeys and display control buttons. These 12 features can be used *in addition to* the features on the call appearance/feature buttons.

The 8405 voice terminal can work in both 4-wire and 2-wire environments. For more information, see "Wiring Information."

 **NOTE:**

As of September 1, 1998, the 8405B Plus (with speakerphone) and the 8405D (with display and listen-only speaker) will be discontinued.

## Applications

---

The 8405 voice terminal can be used with the DEFINITY Communications System Generic 1, Generic 2, and Generic 3, the DEFINITY ECS, System 75, and System 85. This type of voice terminal is especially suitable for managers, executive secretaries, and other office support personnel who require access to multiple lines for call handling, call coverage, bridging, conferencing, and sophisticated voice communications. The display set can be used by those who have a need for calling party display capabilities or who require a large number of voice terminal features.

The 8405 voice terminals can also provide the user with simultaneous voice and data communications. The 8405 can be connected to a 7400B Plus Data Module or 8400B Plus Data Module. With the 8405 voice terminal, PC platform products can be useful in providing voice capabilities since these screen-based products can greatly enhance the telephone capabilities of these voice terminals.

## Physical Features

---

### Dimensions

 **NOTE:**

The dimensions described here for the 8405 voice terminal are approximate.

Width = 7.8 inches

Depth (front to back) = 9.5 inches

Height (maximum with handset in place) = low position, 5.265 inches  
high position, 6.625 inches

12 The 8400 Series Voice Terminals

*The 8405B, 8405B Plus, 8405D, and 8405D Plus Voice Terminals*

12-19

## Features

### Eight Fixed Feature Buttons

The 8405 has the following eight fixed feature buttons:

- CONFERENCE (labeled CONF) button
- DROP button
- TRANSFER button
- A red HOLD button
- Either a blue SHIFT button or a RING button
- MUTE button
- SPEAKER button
- TEST button

### The SHIFT Button

Some 8405 voice terminals have a blue SHIFT button that can be used in the following ways: (The red light next to the SHIFT button goes on steadily when the button is activated.)

- On all 8405 sets, this button can be used with the HOLD button to select your own personalized ring from among eight available patterns.
- On the 8405B Plus and the 8405D Plus, this button can be used with the SPEAKER button to perform an acoustic test of the environment and adjust the speakerphone to the surrounding acoustic environment for optimal performance.

### The RING Button

On other 8405 voice terminals the user can press the RING button in order to select a personalized ringing pattern for the voice terminal. There are eight ringing patterns from which to choose.

### Call Appearance/Feature Buttons

All 8405 voice terminals have five call appearance/feature buttons, each equipped with a red light and a green status light. Usually, at least two of these buttons are administered as call appearances for the terminal's primary extension number, where calls are placed and answered. The remainder of the buttons can be used for more call appearances (including bridged appearances of other stations' extensions) and features. Buttons administered for features have only their green status lights active.

### Message Light

The red Message light goes on when a message is left for the user. It goes off when the user retrieves the message or when the message is erased. This light is labeled either *Message* or .

12 The 8400 Series Voice Terminals

The 8405B, 8405B Plus, 8405D, and 8405D Plus Voice Terminals

12-20

### Speaker (Listen-Only) Feature

The 8405B and the 8405D have a 1-way, listen-only speaker. The 8405B Plus and the 8405D Plus have a two-way speakerphone; however, these two voice terminals can be optioned instead for a 1-way, listen-only speaker. If this is the case, use the SPEAKER button on the front of the voice terminal for turning on and off the speaker.

The Speaker (listen-only) capability allows a user to engage in a 1-way conversation with the far-end. Specifically, the user can only listen to the far-end. To speak with the far-end, the user must use the handset which turns off the speaker. The Speaker function may also be disabled.

### Speakerphone

The 8405B Plus and the 8405D Plus voice terminals are equipped with a built-in 2-way speakerphone. (The voice terminal can be optioned for a 1-way, listen-only speaker instead. The system manager should have records of how this feature is optioned.) The Speakerphone capability allows a user to engage in a hands-free conversation with the far-end party. The speakerphone can be turned on or off with the SPEAKER button; can be muted with the MUTE button, and the volume can be raised and lowered with the VOLUME "arrow" button.

If the voice terminal has a SHIFT button and *Rest Spkr* appears below the SPEAKER button, the user can access the Reset Speakerphone feature to adjust the speakerphone for optimal performance.

#### NOTE:

If there is not a SHIFT button and Reset Spkr does NOT appear under the SPEAKER button, the voice terminal will adjust to the surrounding environment by itself. The user does not need to do anything manually.

By pressing the blue SHIFT button on the set and then the SPEAKER button (if the user has an 8405B Plus or an 8405D Plus and the voice terminal is set for the Speakerphone feature), the user hears a set of tones as the speakerphone performs an acoustic test of the environment. When the tones stop, the speakerphone has finished adjusting itself and is ready for use. The user *must* reset the speakerphone in any of three instances: whenever the voice terminal is moved to another place (even in the same room), whenever the red light next to the SPEAKER button is fluttering, and, when, in the unlikely event, the speakerphone is making a squealing sound.

### MUTE Button

The MUTE button is a fixed feature button with a red status light. The MUTE button turns off the microphone of the built-in speakerphone (only on the 8405B Plus and 8405D Plus) or the handset so that a person can converse with another person in the room without the other party listening in.

12 The 8400 Series Voice Terminals

*The 8405B, 8405B Plus, 8405D, and 8405D Plus Voice Terminals*

12-21

## VOLUME Control Button

The 8405 voice terminal has a VOLUME “arrow” button on the front of the set. This button has several functions. When the user is using the speakerphone or the 1-way speaker, the VOLUME button controls the volume of the speaker. When the user is on a call using the handset, the VOLUME button controls the handset volume. When the voice terminal is idle, the button controls the volume of the tone ringer.

When the user sets the volume for the speaker, speakerphone, handset, or the tone ringer, the display on the 8405D voice terminal shows a “bar array” that indicates the volume setting.

## TEST Button

When the voice terminal is initially powered up, the green light next to the TEST button flashes if the link with the PBX is not (or not yet) operational. The light changes to steady green when the voice terminal is able to communicate with the PBX. After the voice terminal is powered up, you can press the TEST button to test the lights and the display (on the 8405D and 8405D Plus) on your voice terminal.

## Display

The display on the 8405D and the 8405D Plus has two lines with 24 characters on each line. The display, along with the softkeys and the display control buttons, can be used to access 12 softkey features (the default softkey features and the alternative softkey features are listed under “Softkeys”).

## Display Control Buttons

These four buttons are labeled **Menu**, **Exit**, **◀ Prev**, and **Next ▶**.

- **Menu** is used to enter Softkey Mode and access the 12 softkey features.
- **Exit** is used for exiting a display feature and returning to Normal (call-handling) Mode.
- **◀ Prev** and **Next ▶** can be used to go back and forth through the feature option screens.

## Softkeys

The four buttons located below the display and labeled with arrows correspond to features listed on the second line of the display screen. (There are four features on each feature option screen.) The user can access any of the 12 features by pressing the softkey below the feature abbreviation.

12 The 8400 Series Voice Terminals

The 8405B, 8405B Plus, 8405D, and 8405D Plus Voice Terminals

12-22

Below is a list of the 12 default softkey features assigned to the 8405D and 8405D Plus and the order in which they appear.

**Table 12-4. Default Softkey Features on the 8405D and 8405D Plus**

Abbreviation	Feature
<b>First Screen LWC</b>	Leave Word Calling
<b>CnLWC</b>	Cancel Leave Word Calling
<b>AutCB</b>	Automatic Callback
<b>Timer</b>	Timer
<b>Second Screen CFrwd*</b>	Call Forward
<b>CPark†</b>	Call Park
<b>TmDay</b>	Time/Date
<b>PCall</b>	Priority Calling
<b>Third Screen Prog</b>	Abbreviated Dialing Program
<b>Pause</b>	Abbreviated Dialing Special Function Pause
<b>Mark</b>	Abbreviated Dialing Special Function Mark
<b>Wait</b>	Abbreviated Dialing Special Function Wait

\* On a DEFINITY Generic 2 or System 85 switches, this feature is named Call Forward - Follow Me.

† On a DEFINITY G2 and System 85, there is no Call Park feature that can be assigned to a feature button. In order to have the Call Park function on a softkey or hard button, administer the button as an Abbreviated Dial button and program the Call Park trunk group access code onto it. This button can then be labeled "Call Park." In addition, on a DEFINITY G2 or System 85, the Recall feature must be administered on a standard feature button.

On 8405D and 8405D Plus voice terminals connected to a DEFINITY G3V3 or later, the System Manager can choose to administer alternate features for use with the softkeys. The following table lists some of the alternate softkey features that can be substituted for the default softkey features listed on the previous page.

**⇒ NOTE:**

The DEFINITY ECS, Release 5 (and later releases) may provide additional alternate softkey features.

**⇒ NOTE:**

With a DEFINITY G3V3 and later, the system can download *BLANK* softkey labels for positions where there are no features administered.

12 The 8400 Series Voice Terminals

The 8405B, 8405B Plus, 8405D, and 8405D Plus Voice Terminals

12-23

**Table 12-5. Alternate Softkey Features on the 8405D and 8405D Plus Connected to a DEFINITY G3V3 and Later**

Abbreviation	Feature
<b>AD</b>	Abbreviated Dialing buttons (can be multiple AD buttons)
<b>Cnslt</b>	Consult
<b>Count</b>	ACD Stroke Count
<b>CPkup</b>	Call Pickup
<b>Dir*</b>	Directory
<b>Excl</b>	Manual Exclusion
<b>HFAns†</b>	Internal Auto Answer
<b>IAuto</b>	Intercom Auto
<b>IDial</b>	Intercom Dial
<b>Inspt</b>	Inspect
<b>Last</b>	Last Number Dialed
<b>RngOf</b>	Ringer Off
<b>SAC</b>	Send All Calls
<b>SFunc</b>	Abbreviated Dialed Special Function
<b>Spres</b>	Abbreviated Dialing Special Function Suppress
<b>Stats</b>	View (ACD) Statistics
<b>Stop</b>	Abbreviation Dialing Indefinite Wait or Stop
<b>View‡</b>	Stored Number

\* A CALL DISPLAY button should be administered, if access to System Directory is provided. It is also desirable for a NEXT DISPLAY button to be administered. This feature is *not* available on the DEFINITY G2 or System 85.

† This feature is available only on the DEFINITY G3V2 (or later).

‡ This feature is *not* available on a DEFINITY G2 or System 85.

**12 The 8400 Series Voice Terminals**

*The 8405B, 8405B Plus, 8405D, and 8405D Plus Voice Terminals*

12-24

## **Other Physical Features**

### **Handset**

The 8405 voice terminal is equipped with a K-type handset.

### **Dial pad**

The 8405 voice terminal has a 12-button touch-tone dial pad. The letters "Q" and "Z" have been added to the appropriate dial pad keys for directory access, and the "5" button on the dial pad has raised bars for visually-impaired users.

### **Jacks**

The 8405 voice terminal's housing has a Line jack located on the back of the housing, and a Handset cord jack located on the side of the set. There is also a Speakerphone/headset adapter jack to which the user can connect adjunct equipment.

### **Cords**

Two cords are supplied with the 8405: a coiled 9-foot handset cord and a 7-foot line cord.

Optional longer cords are available: a 12-foot handset cord and 14-foot and 25-foot line cords.

### **Ringling**

The 8405 voice terminal has electronic tone ringling with eight possible ringling patterns that can be selected with the RING button on some 8405 voice terminals; on other voice terminals, the user presses the SHIFT button and the HOLD button in order to choose a ringling pattern.

The loudness of the tone ringer can be controlled by the VOLUME "arrow" button. (The user must NOT be on a speakerphone call. If the user is using the speakerphone, the VOLUME "arrow" button controls the volume of the speakerphone.)

### **Mounting Options**

The 8405 voice terminal comes equipped with a 2-position desk stand. This stand can also be removed so the user can mount the set on the wall.

### **Color Options**

The 8405 voice terminal is available in black and in white.



**12** The 8400 Series Voice Terminals*The 8405B, 8405B Plus, 8405D, and 8405D Plus Voice Terminals*

12-25

**Wiring Information**

The 8405 voice terminal works in both 4-wire and 2-wire DCP configurations. The table below describes the pins on an 8400-Series voice terminal LINE jack.

**Table 12-6. The Pins on an 8400-Series Voice Terminal LINE Jack**

Line Interface			
Pin	Pair	Name	Description
1	2	OD1	4-Wire Output
2	2	OD2	4-Wire Output
3	3	ID1	4-Wire Input
4	1	U-T	2-Wire (Tip)
5	1	U-R	2-Wire (Ring)
6	3	ID2	4-Wire Input
7	4	P1-	Adjunct Power -48V
8	4	P2+	Adjunct Power Common

**⇒ NOTE:**

Regardless of which configuration is in use, ALL wiring between the PBX and the terminal MUST consist of twisted-pairs, including the modular line cord. The line cord must be a D8W, which consists of 4 twisted-pairs, or a Lucent Technologies-approved equivalent.

Twisted-pair wiring is used to make lines less sensitive to crosstalk. Therefore, failure to use twisted pair wiring may result in less-than-optimum performance of the terminal and may contribute to problems with the line.

An 8-wire modular cord MUST be used for all 4-wire and any 2-wire installations requiring auxiliary power.

**⇒ NOTE:**

You do NOT need to change any settings on the voice terminal for 2-wire or 4-wire installations. The voice terminal is able to detect whether it is in a 2-wire or a 4-wire configuration.

For 2-wire operation, if you need to plug the voice terminal into a 4-pin or 6-pin wall jack, instead of a standard 8-pin modular jack, refer to the "Line Interface" table to insure that the wires from the 4-pin or 6-pin wall jack are connected to the correct pins on the terminal "LINE" jack.

**12** The 8400 Series Voice Terminals

*The 8405B, 8405B Plus, 8405D, and 8405D Plus Voice Terminals*

12-26

In order for the terminal to function properly in either 2-wire or 4-wire installations, there must be NO INTERCONNECTIONS between the wire pairs used for 2-wire and 4-wire operations. Bridging or paralleling of these pairs can result in damage to the terminal or can cause the PBX circuit pack to remove power to the terminal.

REMOVE ALL CONNECTIONS BETWEEN PAIRS BEFORE CONNECTING THE TERMINAL.

4-WIRE installations MUST ONLY have PBX connections on pair 2 and pair 3 and, if necessary, auxiliary power must be connected to pair 4.

2-WIRE installations MUST ONLY have PBX connections on pair 1 and, if necessary, auxiliary power must be connected to pair 4.

**Distance Limitations**

---

The following circuit packs can be used with all of the 8400-Series sets.

**Table 12-7. Circuit Packs Used with the 8400-Series Voice Terminals**

Circuit Pack	2/4-Wire	Will support these switches
TN2181 - 16-port	2-wire	G3V2 and later
TN754b - 8-port	4-wire	All switches except System 85
TN754 - 8-port	4-wire	All switches except System 85
TN413 - 8-port	4-wire	International System 75
SN 270 and SN 270B - 4-port	4-wire	System 85 R2V2 - R2V4

**In 4-wire operation**, the voice terminal must be within 5,000 feet of the PBX using 22-gauge or 24-gauge wire, and within 4,000 feet of the PBX using 26-gauge wire.

**In 2-wire operation**, the voice terminal must be within 5,500 feet of the PBX using 22-gauge wire, within 3,500 feet of the PBX using 24-gauge wire, and within 2,200 feet of the PBX using 26-gauge wire.

**Power Requirements**

---

The 8405 voice terminal receives power from the system and does not require any external power supply. Additional external power IS required when the 8405 voice terminal is equipped with any adjuncts, such as an external speakerphone. In this instance, a 1151A1 local power supply or a 1151A2 power supply with Battery Holdover is recommended. Refer to the **Adjunct Power** section earlier in this manual for more information on these power supplies.

**12 The 8400 Series Voice Terminals**

*The 8405B, 8405B Plus, 8405D, and 8405D Plus Voice Terminals*

12-27

**Switch Administration**

---

**Aliasing**

Use the following table for administering 8405B and 8405B Plus voice terminals:

**Table 12-8. Administering the 8405B and 8405B Plus Voice Terminals**

<b>If you have this System</b>	<b>and this Release</b>	<b>(which can support this type of operation)</b>	<b>Administer 8405B or 8405B Plus as a</b>
System 75	R1V1 — R1V3	4-wire only	7403D
System 85	R2V2 — R2V4	4-wire only	7403D
International System 75	IR1V4, etc.	4-wire only	7403D
DEFINITY G1		4-wire only	7403D
Global DEFINITY '91		4-wire only	7410D
DEFINITY G2V1		4-wire only	7410D
DEFINITY G2V2		4-wire only	7410D
DEFINITY G3i, G3r, G3s, G3vs		4-wire only	7410D
DEFINITY G3V2		2- or 4-wire	7410D
DEFINITY G3V3		2- or 4-wire	8410B
DEFINITY G3V4 and later		2- or 4-wire	8405B or 8405B Plus

**⇒ NOTE:**

When administering the 8405B and 8405D voice terminal on a DEFINITY G3V4 or a DEFINITY ECS, you must select “One-way” or “None” as the speaker option on the 8410 Administration Form. If the voice terminal is incorrectly optioned as having a two-way speakerphone, the light next to the Speaker button will continually flutter. In that case, you must readminister the terminal.

12 The 8400 Series Voice Terminals

The 8405B, 8405B Plus, 8405D, and 8405D Plus Voice Terminals

12-28

Use the following table for administering the 8405D and 8405D Plus voice terminals:

**Table 12-9. Administering the 8405D and 8405D Plus Voice Terminals**

If you have this System	and this Release	(which can support this type of operation)	Administer the 8405D or 8405D Plus as a
System 75	R1V1 — R1V3	4-wire only	7405D+D
System 85	R2V2 — R2V4	4-wire only	7405D+D
International System 75	IR1V4, etc.	4-wire only	7405D+D
DEFINITY G1	R1V4	4-wire only	7405D+D
Global DEFINITY '91		4-wire only	7405D+D
DEFINITY G2V1		4-wire only	7405D+D
DEFINITY G2V2		4-wire only	7405D+D
DEFINITY G3i, G3r, G3s, G3vs		4-wire only	7405D+D
DEFINITY G3V2		2- or 4-wire	7405D+D
DEFINITY G3V3		2- or 4-wire	8410D
DEFINITY G3V4 and later		2- or 4-wire	8405D or 8405D Plus

**⇒ NOTE:**

When administering the 8405B and 8405D voice terminal on a DEFINITY G3V4 or a DEFINITY ECS, you must select "One-way" or "None" as the speaker option on the 8410 Administration Form. If the voice terminal is incorrectly optioned as having a two-way speakerphone, the light next to the Speaker button will continually flutter. In that case, you must readminister the terminal.

**Button Numbering**

The following button diagrams of the 8405 voice terminals will help you administer all four versions of this voice terminals connected to a System 75, DEFINITY G1 and G3, or DEFINITY ECS, and to a System 85 or a DEFINITY G2.

Figure 12-9 shows button numbering for the 8405 connected to a System 75, DEFINITY G1 and G3, or DEFINITY ECS. Figure 12-10 shows button numbering for the 8405 connected to a System 85 or DEFINITY G2.

12 The 8400 Series Voice Terminals

The 8405B, 8405B Plus, 8405D, and 8405D Plus Voice Terminals

12-29

If you need more information, refer to *DEFINITY Communications System Generic 3 Implementation*, 555-230-653, and *DEFINITY Communications System Generic 2 Administration of Features and Hardware*, 555-104-507.

If the 8405D or 8405D Plus is administered as a 7405D, administer the 12 softkey features on "FEATURE BUTTON ASSIGNMENTS" 2 through 13; administer the Normal feature on Button #1.

If the 8405D or 8405D Plus is administered as an 8410D, administer the 12 softkey features on "SOFTKEY BUTTON ASSIGNMENTS" 1 through 12.

The 5 call appearance/feature buttons are administered as "BUTTON ASSIGNMENTS" 1 through 5.

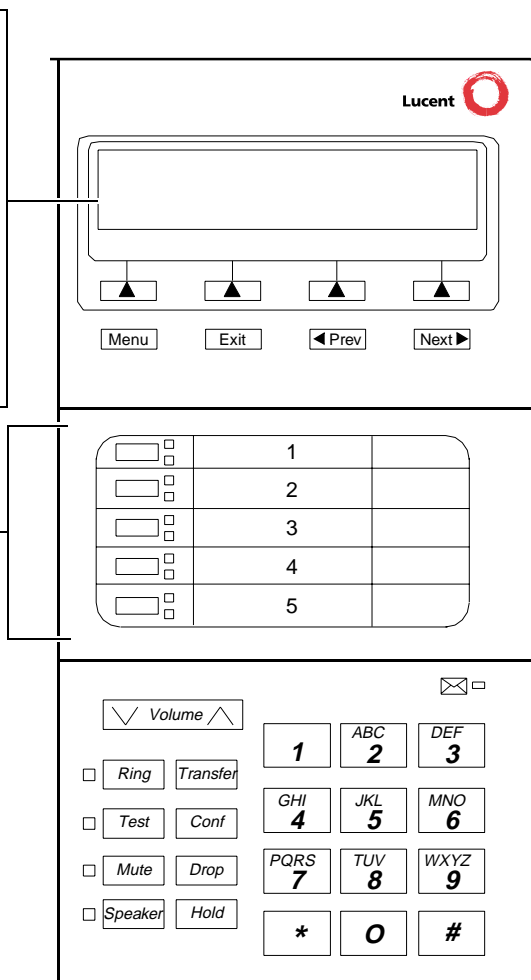

Figure 12-9. Button Numbering for Administering the 8405 Voice Terminal Connected to a System 75, a DEFINITY G1 or G3, or a DEFINITY ECS

12 The 8400 Series Voice Terminals

The 8405B, 8405B Plus, 8405D, and 8405D Plus Voice Terminals

12-30

If the 8405D or 8405D Plus is administered as a 7405D, administer the 12 softkey features on "FEATURE BUTTON ASSIGNMENTS" 14 through 25; administer the Normal feature on Button #13.

If the 8405D or 8405D Plus is administered as an 8410D, administer the 12 softkey features on "SOFTKEY BUTTON ASSIGNMENTS" 1 through 12.

The 5 call appearance/feature buttons are administered as "BUTTON ASSIGNMENTS" 3 through 7.

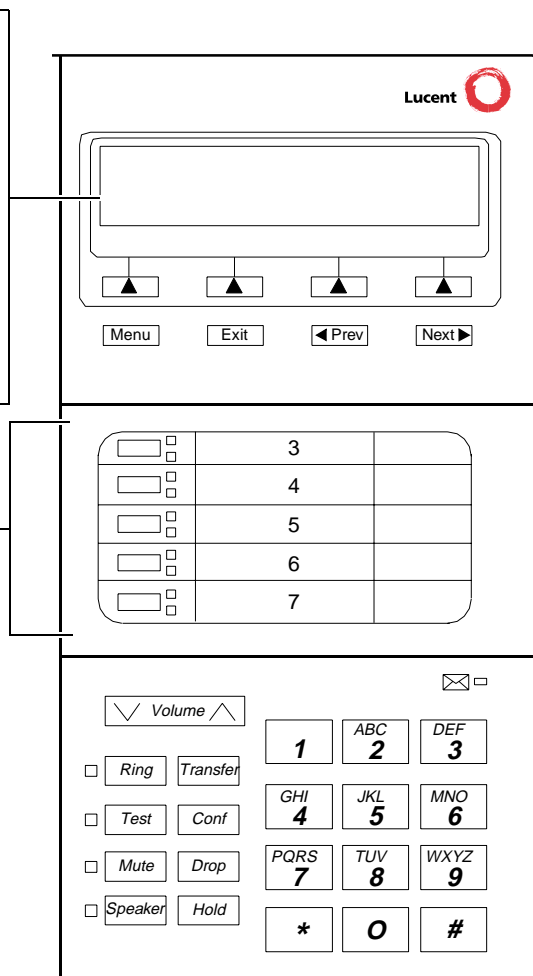

Figure 12-10. Button Numbering for Administering the 8405 Voice Terminal Connected to a System 85 or a DEFINITY G2

### Power Failure Operation

The 8405 voice terminal cannot be used as an emergency station during power failure transfer conditions.

### FCC Registration

The 8405 voice terminal is FCC-registered along with the switch (as a system), but does not have a separate FCC registration label.

**12** The 8400 Series Voice Terminals

*The 8405B, 8405B Plus, 8405D, and 8405D Plus Voice Terminals*

12-31

## UL and CSA Approval

The 8405 voice terminal has been tested and has met the Underwriters Laboratories (UL) Standards UL 1459 and has also met the Canadian Standards Association (CSA) Standards CSA-C22.2 No.225-M90.

## Hearing Aid Compatible

All 8405 voice terminals are compatible with the inductively coupled hearing aids prescribed by the FCC.

## 8405 Equipment PECs and Comcodes

The 8405 voice terminals and components can be ordered with these PECs and Comcodes:

- **8405B (8405D08A) Voice Terminal (without display, with one-way speaker)**  
Black 8405B Set PEC: 3233-5BB  
Comcode: 107858847;  
White 8405B Set PEC: 3233-5BW  
Comcode: 107858854
- **8405B Plus (8405D06A) Voice Terminal (without display, with two-way speakerphone)**  
Black 8405B Plus Set PEC: 3233-5SB  
Comcode: 107858359;  
White 8405B Plus Set PEC: 3233-5SW  
Comcode: 107858367
- **8405D (8405D07A) Voice Terminal (with built-in display and one-way speaker)**  
Black 8405D Set PEC: 3233-6BB  
Comcode: 107858615;  
White 8405D Set PEC: 3233-6BW  
Comcode: 107858623
- **8405D Plus (8405D05A) Voice Terminal (with built-in display and two-way speakerphone)**  
Black 8405D Plus Set PEC: 3233-6SB  
Comcode: 107858110;  
White 8405D Plus Set PEC: 3233-6SW  
Comcode: 107858128
- **K2S8 Handset**  
Comcode: Black=107545584; White=107545568
- **Handset cord (9 feet)**  
Comcode: Black=407632819; White=407632835
- **Line cord (7 feet)**  
Comcode: 103786778

12 The 8400 Series Voice Terminals

*The 8405B, 8405B Plus, 8405D, and 8405D Plus Voice Terminals*

12-32

- **Line cord (14 feet, silver)**  
PEC: 2725-07N (COL18)  
Comcode: 103786828
- **Line cord (25 feet, silver)**  
PEC: 2725-07S (COL18)  
Comcode: 103786802
- **Button Designation Card**  
Tractor Feed For 25 Sets  
PEC: 32310A  
Comcode: 847770666;  
Tractor Feed For 100 Sets  
PEC: 32311A  
Comcode: 847770674

## Adjuncts

---

The following adjuncts can be used with the 8405 voice terminal:

- S101A Speakerphone (no longer orderable)
- S201A Speakerphone
- CS201A Speakerphone
- 7400B Plus Data Module
- 8400B Plus Data Module
- 500A1 Headset Adapter (and a standard headset; see “Headsets” below)
- K6S2 Amplifier Handset
- Shoulder Rest

## Headsets

A list of compatible headsets, consisting of both modular and plug prong base units and selection of headpieces, appears in “Headset Adapters” in the **Adjuncts** section later in this manual.



**12** The 8400 Series Voice Terminals

*The 8405B, 8405B Plus, 8405D, and 8405D Plus Voice Terminals*

12-33

## **Additional Documents**

---

The following documents contain additional information relating to the 8405 voice terminal: (Use the 9 digit number listed after each document to order that book from the BCS Publications Center for Lucent Technologies.)

- *The 8400-Series Voice Terminals Installation and User's Manual, 555-230-875*
- *The 8400-Series Voice Terminals Instructions for Installation, Switch Administration, and Programming the Options, 555-015-725*
- *DEFINITY Enterprise Communications Server Generic 1 and System 75 8405 Voice Terminal User's Guide, 555-230-736*
- *DEFINITY Enterprise Communications Server Generic 1 and 3 and System 75 8405 Quick Reference Guide, 555-230-737*
- *DEFINITY Enterprise Communications Server Generic 2 and System 85 8405 Voice Terminal User's Guide, 555-104-726*
- *DEFINITY Enterprise Communications Server Generic 2 and System 85 8405 Quick Reference Guide, 555-104-725*

# The 8410 Voice Terminal

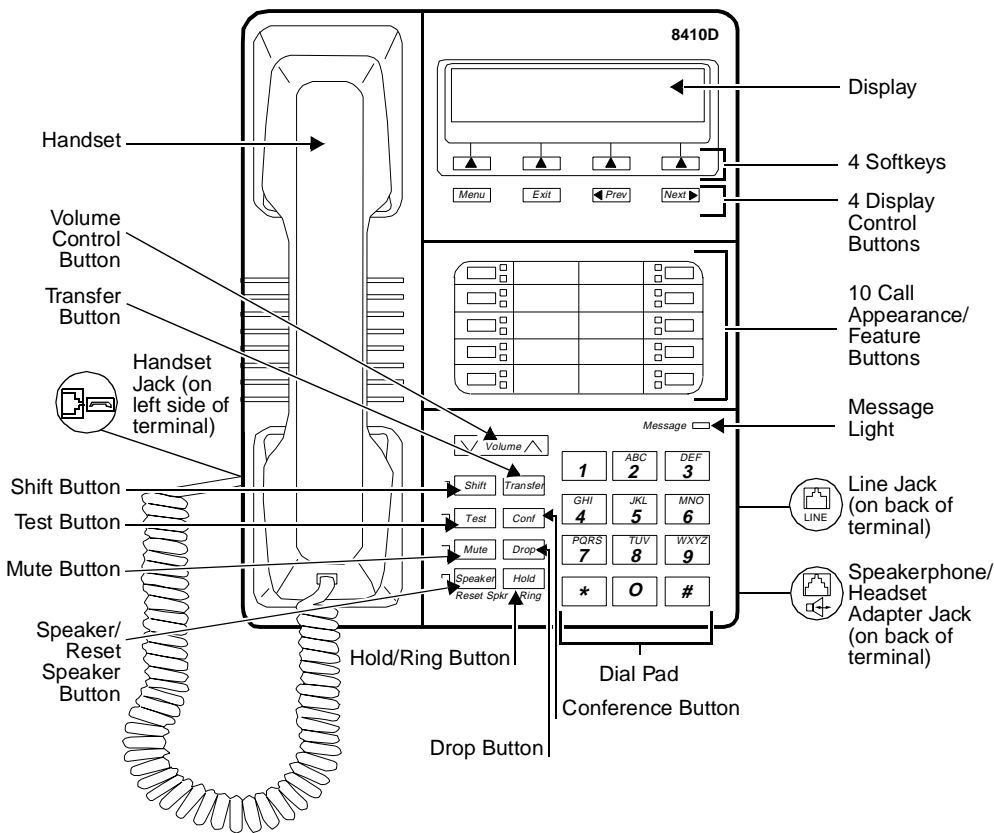

Figure 12-11. One Version of the 8410D Voice Terminal (with Display)

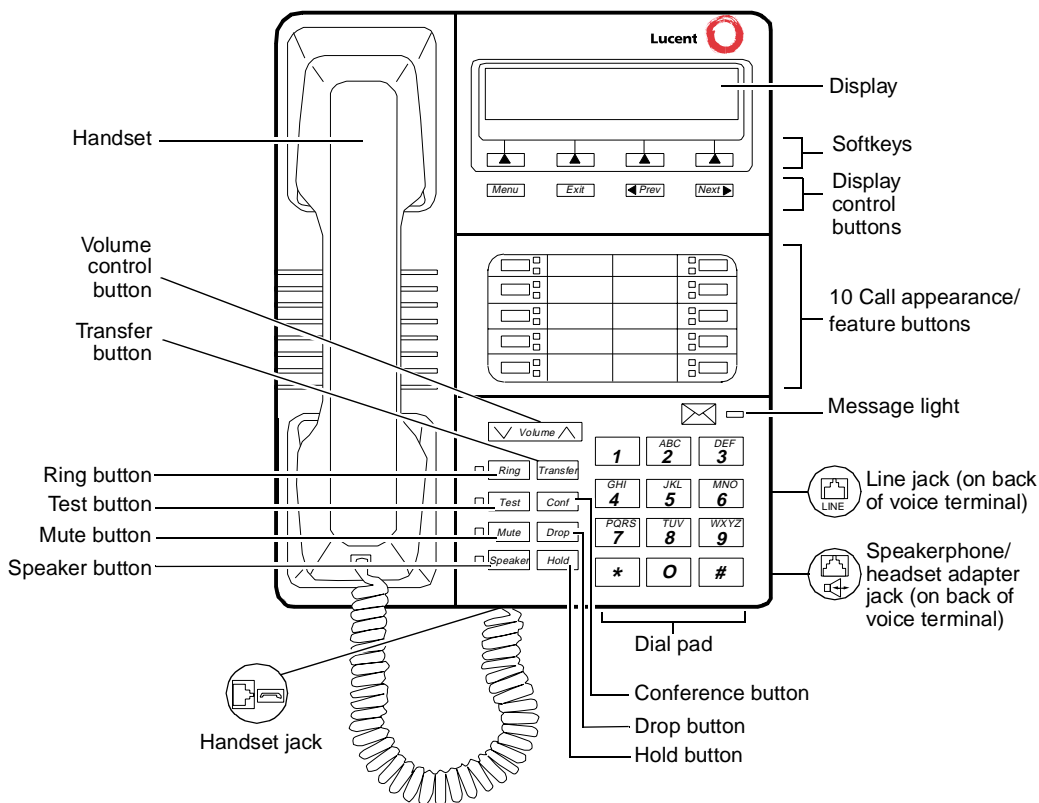

Figure 12-12. Another Version of the 8410D Voice Terminal

The 8410 voice terminal is a multi-appearance digital telephone with 10 call appearance/feature buttons, four standard fixed feature buttons (CONFERENCE, DROP, HOLD, and TRANSFER), a MUTE button, a SPEAKER button which can access either a 2-way speakerphone or a 1-way, listen-only speaker, a TEST button, and a Volume control button. In addition, some 8410 voice terminals have a blue SHIFT button; other 8410 voice terminals have a RING button instead.

There are two varieties of the 8410 voice terminal: the 8410B (8410D04A) is the basic set, without a display; the 8410D (8410D03A) has a built-in 2-line by 24-character display.

**NOTE:**

The 8410D01A and 8410D02A are older versions of this voice terminal and are no longer available.

Those users who have an 8410D with display can access 12 features with the softkeys and display control buttons. These 12 features can be used *in addition to* the features on the call appearance/feature buttons.

The 8410 voice terminal can work in both 4-wire and 2-wire environments. For more information, see "Wiring Information."

## Applications

---

The 8410 voice terminal can be used with the DEFINITY Communications System Generic 1, Generic 2, or Generic 3, the DEFINITY ECS, System 75, and System 85. This type of voice terminal is especially suitable for managers, executive secretaries, and other office support personnel who require access to multiple lines for call handling, call coverage, bridging, conferencing, and sophisticated voice communications. The display set can be used by those who have a need for calling party display capabilities or who require a large number of voice terminal features.

The 8410 voice terminals can also provide the user with simultaneous voice and data communications. The 8410 can be connected to a 7400B Plus Data Module. With the 8410 voice terminal, PC platform products can be useful in providing voice capabilities since these screen-based products can greatly enhance the telephone capabilities of these voice terminals.

## Physical Features

---

### Dimensions

#### NOTE:

The dimensions described here for the 8410 voice terminal are approximate.

Width = 7.8 inches

Depth (front to back) = 9.5 inches

Height (maximum with handset in place) = low position, 5.265 inches  
high position, 6.625 inches

### Features

#### Eight Fixed Feature Buttons

The 8410 has the following eight fixed feature buttons:

- CONFERENCE (labeled CONF) button
- DROP button
- TRANSFER button
- A red HOLD button
- Either a blue SHIFT button or a RING button

- MUTE button
- SPEAKER button
- TEST button

### The SHIFT Button

Some 8410 voice terminals have a blue SHIFT button that can be used in the following ways: (The red light next to the SHIFT button goes on steadily when the button is activated.)

- Used with the HOLD button to select your own personalized ring from among eight available patterns
- Used with the SPEAKER button to perform an acoustic test of the environment and adjust the speakerphone to the surrounding acoustic environment for optimal performance

### The RING Button

On other 8405 voice terminals, the user can press the RING button in order to select a personalized ringing pattern for the voice terminal. There are eight ringing patterns from which to choose.

### Call Appearance/Feature Buttons

The 8410 voice terminal has 10 call appearance/feature buttons, each equipped with a red light and a green status light. Usually, at least three of these buttons are administered as call appearances for the terminal's primary extension number, where calls are placed and answered. The rest of the buttons can be used for more call appearances (including bridged appearances of other stations' extensions) and features. Buttons administered for features have only their green status lights active.

### Message Light

The red Message light goes on when a message is left for the user. It goes off when the user retrieves the message or when the message is erased. This light is labeled either *Message* or .

### Speakerphone

The 8410 voice terminal is equipped with a built-in speakerphone. (The voice terminal can be optioned for a 1-way, listen-only speaker instead.) The Speakerphone capability allows a user to engage in a hands-free conversation with the far-end party. The speakerphone can be turned on or off with the SPEAKER button; can be muted with the MUTE button, and the volume can be raised and lowered with the VOLUME "arrow" button.

If the voice terminal has a SHIFT button and *Rest Spkr* appears below the SPEAKER button, the user can access the Reset Speakerphone feature to adjust the speakerphone for optimal performance.

 **NOTE:**

If there is not a SHIFT button and Reset Spkr does NOT appear under the SPEAKER button, the voice terminal will adjust to the surrounding environment by itself. The user does not need to do anything manually.

By pressing the blue SHIFT button on the set and then the SPEAKER button (if the voice terminal is set for the Speakerphone feature), the user hears a set of tones as the speakerphone performs an acoustic test of the environment. When the tones stop, the speakerphone has finished adjusting itself and is ready for use. The user *must* reset the speakerphone in any of three instances: whenever the voice terminal is moved to another place (even in the same room), whenever the red light next to the SPEAKER button is fluttering, and, when, in the unlikely event, the speakerphone is making a squealing sound.

### **Speaker (Listen-Only) Feature**

Although the 8410 voice terminal is shipped from the factory with the terminal set for the Speakerphone feature, the 8410 voice terminal can be optioned instead for a 1-way, listen-only speaker. If this is the case, use the SPEAKER button on the front of the voice terminal for turning on and off the speaker.

The Speaker (listen-only) capability allows a user to engage in a 1-way conversation with the far-end. Specifically, the user can only listen to the far-end. To speak with the far-end, the user must use the handset which turns off the speaker. The Speaker function may also be disabled.

### **MUTE Button**

The MUTE button is a fixed feature button with a red status light. The MUTE button turns off the microphone of the built-in speakerphone or the handset so that a person can converse with another person in the room without the other party listening in.

### **VOLUME Control Button**

The 8410 voice terminal has a VOLUME “arrow” button on the front of the set. This button has several functions. When the user is using the speakerphone or the 1-way speaker, the VOLUME button controls the volume of the speaker. When the user is on a call using the handset, the VOLUME button controls the handset volume. When the voice terminal is idle, the button controls the volume of the tone ringer.

When the user sets the volume for the speaker, speakerphone, handset, or the tone ringer, the display on the 8410D voice terminal shows a “bar array” that indicates the volume setting.

## TEST Button

When the voice terminal is initially powered up, the green light next to the TEST button flashes if the link with the PBX is not (or not yet) operational. The light changes to steady green when the voice terminal is able to communicate with the PBX. After the voice terminal is powered up, you can press the TEST button to test the lights and the display on your voice terminal.

## Display

The display on the 8410D set has two lines with 24 characters on each line. The display, along with the softkeys and the display control buttons, can be used to access 12 softkey features (the default softkey features and the alternative softkey features are listed under "Softkeys").

## Display Control Buttons

These four buttons are labeled **Menu**, **Exit**, **◀ Prev**, and **Next ▶**.

- **Menu** is used to enter Softkey Mode and access the 12 softkey features.
- **Exit** is used for exiting a display feature and returning to Normal (call-handling) Mode.
- **◀ Prev** and **Next ▶** can be used to go back and forth through the feature option screens.

## Softkeys

The four buttons located below the display and labeled with arrows correspond to features listed on the second line of the display screen. (There are four features on each feature option screen.) The user can access any of the 12 features by pressing the softkey below the feature abbreviation.

Below is a list of the 12 default softkey features assigned to the 8410 and the order in which they appear.

**Table 12-10. Default Softkey Features on the 8410**

Abbreviation	Feature
<b>First Screen LWC</b>	Leave Word Calling
<b>CnLWC</b>	Cancel Leave Word Calling
<b>AutCB</b>	Automatic Callback
<b>Timer</b>	Timer
<b>Second Screen CFrwd*</b>	Call Forward
<b>CPark†</b>	Call Park
<b>TmDay</b>	Time/Date
<b>PCall</b>	Priority Calling
<b>Third Screen Prog</b>	Abbreviated Dialing Program
<b>Pause</b>	Abbreviated Dialing Special Function Pause
<b>Mark</b>	Abbreviated Dialing Special Function Mark
<b>Wait</b>	Abbreviated Dialing Special Function Wait

\* On a DEFINITY Generic 2 or on a System 85, this feature is named Call Forward-Follow Me.

† On a DEFINITY G2 and on a System 85, there is no Call Park feature that can be assigned to a feature button. In order to have the Call Park function on a softkey or hard button, administer the button as an Abbreviated Dial button and program the Call Park trunk group access code onto it. This button can then be labeled "Call Park." In addition, on a DEFINITY G2 or a System 85, the Recall feature must be administered on a standard feature button.

On 8410D voice terminals (8410 terminals with a display) connected to a DEFINITY G3V3 or later, the System Manager can choose to administer alternate features for use with the softkeys. The following table lists some of the alternate softkey features, those features that can be substituted for the default softkey features listed on the previous page.

**⇒ NOTE:**  
 The DEFINITY ECS Release 5 (and later releases) may provide additional alternate softkey features.

**⇒ NOTE:**  
 With G3V3 and later switches, the system can download *BLANK* softkey labels for positions where there are no features administered.



**Table 12-11. Alternate Softkey Features on the 8410 Connected to a DEFINITY G3V3 and Later**

Abbreviation	Feature
<b>AD</b>	Abbreviated Dialing buttons (can be multiple AD buttons)
<b>Cnslt</b>	Consult
<b>Count</b>	ACD Stroke Count
<b>CPkup</b>	Call Pickup
<b>Dir*</b>	Directory
<b>Excl</b>	Manual Exclusion
<b>HFAns†</b>	Internal Auto Answer
<b>IAuto</b>	Intercom Auto
<b>IDial</b>	Intercom Dial
<b>Inspt</b>	Inspect
<b>Last</b>	Last Number Dialed
<b>RngOf</b>	Ringer Off
<b>SAC</b>	Send All Calls
<b>SFunc</b>	Abbreviated Dialed Special Function
<b>Spres</b>	Abbreviated Dialing Special Function Suppress
<b>Stats</b>	View (ACD) Statistics
<b>Stop</b>	Abbreviation Dialing Indefinite Wait or Stop
<b>View‡</b>	Stored Number

\* A CALL DISPLAY button should be administered, if access to System Directory is provided. It is also desirable for a NEXT DISPLAY button to be administered. This feature is *not* available on a DEFINITY G2 or System 85.

† This feature is *not* available on a DEFINITY G2 or System 85.

‡ This feature is available only on a DEFINITY G3V2 (or later) switches.

## **Other Physical Features**

### **Handset**

The 8410 voice terminal is equipped with a K-type handset.

### **Dial Pad**

The 8410 voice terminal has a 12-button touch-tone dial pad. The letters "Q" and "Z" have been added to the appropriate dial pad keys for directory access, and the "5" button on the dial pad has raised bars for visually-impaired users.

### **Jacks**

The 8410 voice terminal's housing has a Line jack located on the back of the housing, and a Handset cord jack located on the side of the set. There is also a Speakerphone/headset adapter jack to which the user can connect adjunct equipment.

### **Cords**

Two cords are supplied with the 8410: a coiled 9-foot handset cord and a 7-foot line cord.

Optional longer cords are available: a 12-foot handset cord and 14-foot and 25-foot line cords.

### **Ringling**

The 8410 voice terminal has electronic tone ringling with eight possible ringling patterns that can be selected with the RING button on some 8405 voice terminals; on other voice terminals, the user presses the SHIFT button and the HOLD button in order to choose a ringling pattern.

The loudness of the tone ringer can be controlled by the VOLUME "arrow" button. (The user must NOT be on a speakerphone call. If the user is using the speakerphone, the VOLUME "arrow" button controls the volume of the speakerphone.)

### **Mounting Options**

The 8410 voice terminal comes equipped with a 2-position desk stand. This stand can also be removed so the user can mount the set on the wall.

### **Color Options**

The 8410 voice terminal is available in black and in white.

## Wiring Information

The 8410 voice terminal works in both 4-wire and 2-wire DCP configurations. The table below describes the pins on an 8400-Series voice terminal LINE jack.

**Table 12-12. The Pins on an 8400-Series Voice Terminal LINE Jack**

Line Interface			
Pin	Pair	Name	Description
1	2	OD1	4-Wire Output
2	2	OD2	4-Wire Output
3	3	ID1	4-Wire Input
4	1	U-T	2-Wire (Tip)
5	1	U-R	2-Wire (Ring)
6	3	ID2	4-Wire Input
7	4	P1-	Adjunct Power -48V
8	4	P2+	Adjunct Power Common

**⇒ NOTE:**

Regardless of which configuration is in use, ALL wiring between the PBX and the terminal MUST consist of twisted-pairs, including the modular line cord. The line cord must be a D8W, which consists of 4 twisted-pairs, or a Lucent Technologies-approved equivalent.

Twisted-pair wiring is used to make lines less sensitive to crosstalk. Therefore, failure to use twisted pair wiring may result in less-than-optimum performance of the terminal and may also contribute to problems with the line.

An 8-wire modular cord MUST be used for all 4-wire and any 2-wire installations requiring auxiliary power.

**⇒ NOTE:**

You do NOT need to change any settings on the voice terminal for 2-wire or 4-wire installations. The voice terminal is able to detect whether it is in a 2-wire or a 4-wire configuration.

For 2-wire operation, if you need to plug the voice terminal into a 4-pin or 6-pin wall jack, instead of a standard 8-pin modular jack, refer to the "Line Interface" table to insure that the wires from the 4-pin or 6-pin wall jack are connected to the correct pins on the terminal "LINE" jack.

In order for the terminal to function properly in either 2-wire or 4-wire installations, there must be NO INTERCONNECTIONS between the wire pairs used for 2-wire and 4-wire operations. Bridging or paralleling of these pairs can result in damage to the terminal or can cause the PBX circuit pack to remove power to the terminal.

REMOVE ALL CONNECTIONS BETWEEN PAIRS BEFORE CONNECTING THE TERMINAL.

4-WIRE installations MUST ONLY have PBX connections on pair 2 and pair 3 and, if necessary, auxiliary power must be connected to pair 4.

2-WIRE installations MUST ONLY have PBX connections on pair 1 and, if necessary, auxiliary power must be connected to pair 4.

## Distance Limitations

---

The following circuit packs can be used with all of the 8400-Series sets.

**Table 12-13. Circuit Packs Used with the 8400-Series Voice Terminals**

Circuit Pack	2/4-Wire	Will support these switches
TN2181 - 16-port	2-wire	G3V2 and later
TN754b - 8-port	4-wire	All switches except System 85
TN754 - 8-port	4-wire	All switches except System 85
TN413 - 8-port	4-wire	International System 75
SN 270 and SN 270B - 4-port	4-wire	System 85 R2V2 - R2V4

**In 4-wire operation**, the voice terminal must be within 5,000 feet of the PBX using 22-gauge or 24-gauge wire, and within 4,000 feet of the PBX using 26-gauge wire.

**In 2-wire operation**, the voice terminal must be within 5,500 feet of the PBX using 22-gauge wire, within 3,500 feet of the PBX using 24-gauge wire, and within 2,200 feet of the PBX using 26-gauge wire.

## Power Requirements

---

The 8410 voice terminal receives power from the system and does not require any external power supply. Additional external power IS required when the 8410 voice terminal is equipped with any adjuncts, such as an external speakerphone. In this instance, a 1151A1 local power supply or a 1151A2 power supply with Battery Holdover is recommended. Refer to the **Adjunct Power** section earlier in this manual for more information on these power supplies.

## **Switch Administration**

---

### **Aliasing**

Use the following table for administering the 8410B (the basic) voice terminal:

**Table 12-14. Administering the 8410B Voice Terminal**

<b>If you have this System</b>	<b>and this Release</b>	<b>(which can support this type of operation)</b>	<b>Administer the 8410B as a</b>
System 75	R1V1 — R1V3	4-wire only	7403D
System 85	R2V2 — R2V4	4-wire only	7403D
International System 75	IR1V4, etc.	4-wire only	7403D
DEFINITY G1		4-wire only	7403D
Global DEFINITY '91		4-wire only	7410D
DEFINITY G2V1		4-wire only	7410D
DEFINITY G2V2		4-wire only	7410D
DEFINITY G3i, G3r, G3s, G3vs		4-wire only	7410D
DEFINITY G3V2		2- or 4-wire	7410D
DEFINITY G3V3 and later		2- or 4-wire	8410B

Use the following table for administering the 8410D voice terminal (with display):

**Table 12-15. Administering the 8410D Voice Terminal**

If you have this System	and this Release	(which can support this type of operation)	Administer the 8410D as a
System 75	R1V1 — R1V3	4-wire only	7405D+D
System 85	R2V2 — R2V4	4-wire only	7405D+D
International System 75	IR1V4, etc.	4-wire only	7405D+D
DEFINITY G1	R1V4	4-wire only	7405D+D
Global DEFINITY '91		4-wire only	7405D+D
DEFINITY G2V1		4-wire only	7405D+D
DEFINITY G2V2		4-wire only	7405D+D
DEFINITY G3i, G3r, G3s, G3vs		4-wire only	7405D+D
DEFINITY G3V2		2- or 4-wire	7405D+D
DEFINITY G3V3 and later		2- or 4-wire	8410D

## Button Numbering

The following button diagrams of the 8410 voice terminal will help you administer both of these voice terminals connected to a System 75, a DEFINITY G1 and G3, or a DEFINITY ECS, and to a System 85 or a DEFINITY G2.

Figure 12-13 shows button numbering for the 8410 connected to a System 75, a DEFINITY G1 and G3, or a DEFINITY ECS. Figure 12-14 shows button numbering for the 8410 connected to a System 85 or DEFINITY G2.

If you need more information, refer to *DEFINITY Communications System Generic 3 Implementation*, 555-230-653, and *DEFINITY Communications System Generic 2 Administration of Features and Hardware*, 555-104-507.

If the 8410D is administered as a 7405D, administer the 12 softkey features on "FEATURE BUTTON ASSIGNMENTS" 2 through 13; administer the Normal feature on Button #1.

If the 8410D is administered as itself, administer the 12 softkey features on "SOFTKEY BUTTON ASSIGNMENTS" 1 through 12.

The 10 call appearance/feature buttons are administered as "BUTTON ASSIGNMENTS" 1 through 10.

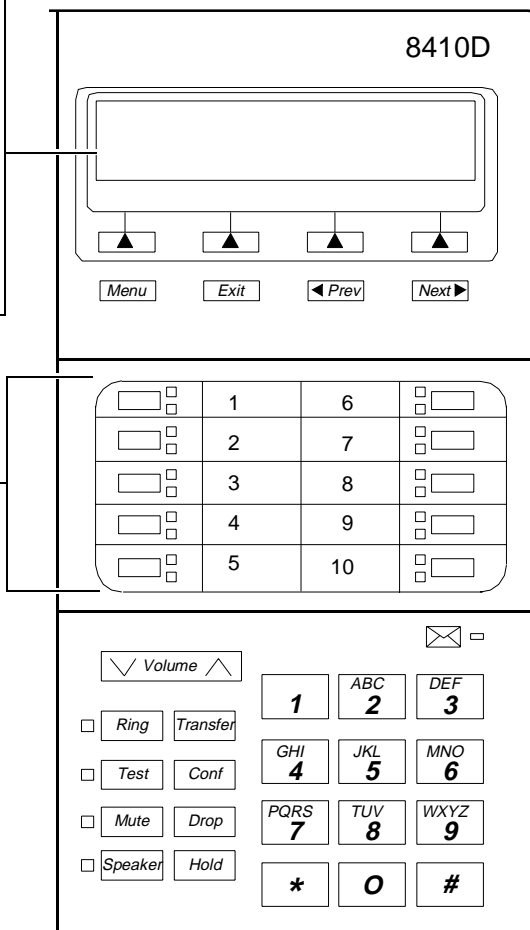

**Figure 12-13. Button Numbering for Administering the 8410 Voice Terminal Connected to a System 75, a DEFINITY G1 or G3, or a DEFINITY ECS**

If the 8410D is administered as a 7405D, administer the 12 softkey features on "FEATURE BUTTON ASSIGNMENTS" 14 through 25; administer the Normal feature on Button #13.

If the 8410D is administered as itself, administer the 12 softkey features on "SOFTKEY BUTTON ASSIGNMENTS" 1 through 12.

The 10 call appearance/feature buttons are administered as "BUTTON ASSIGNMENTS" 3 through 12.

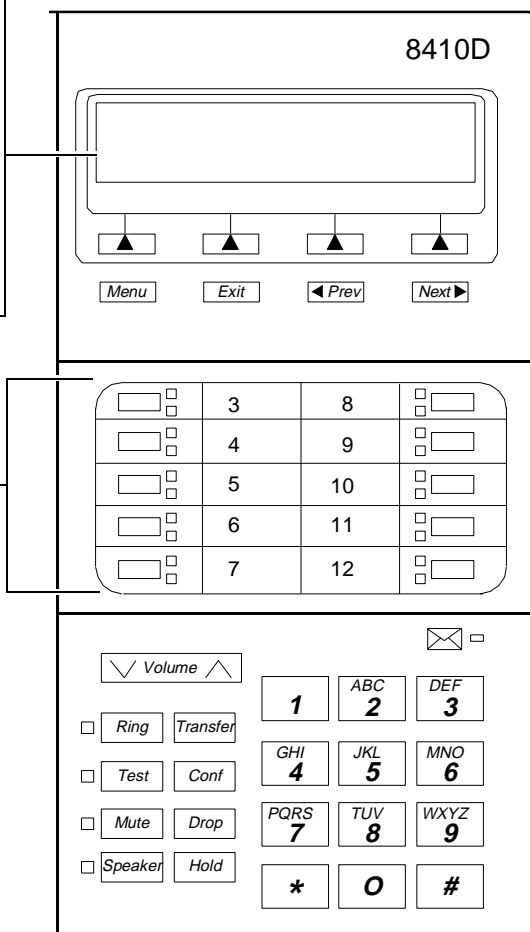

Figure 12-14. Button Numbering for Administering the 8410 Voice Terminal Connected to a System 85 or a DEFINITY G2

### Power Failure Operation

The 8410 voice terminal cannot be used as an emergency station during power failure transfer conditions.

### FCC Registration

The 8410 voice terminal is FCC-registered along with the switch (as a system), but does not have a separate FCC registration label.



## UL and CSA Approval

The 8410 voice terminal has been tested and has met the Underwriters Laboratories (UL) Standards UL 1459 and has also met the Canadian Standards Association (CSA) Standards CSA-C22.2 No.225-M90.

## Hearing Aid Compatible

The 8410B and 8410D voice terminals are compatible with the inductively coupled hearing aids prescribed by the FCC.

## 8410 Equipment PECs and Comcodes

The 8410B and 8410D voice terminals and components can be ordered with these PECs and Comcodes:

- **Basic 8410B (8410D04A) Voice Terminal**
  - Black 8410B Set PEC: 3234-04B
  - Comcode: 107703696;
  - White 8410B Set PEC: 3234-04W
  - Comcode: 107703738
- **8410D (8410D03A) Voice Terminal (with built-in display)**
  - Black 8410D Set PEC: 3235-05B
  - Comcode: 107702870;
  - White 8410D Set PEC: 3235-05W
  - Comcode: 107702920
- **K2S8 Handset**
  - Comcode: Black=107545584; White=107545568
- **Handset cord (9 feet)**
  - Comcode: Black=407632819; White=407632835
- **Line cord (7 feet)**
  - Comcode: 103786778
- **Line cord (14 feet, silver)**
  - PEC: 2725-07N (COL18)
  - Comcode: 103786828
- **Line cord (25 feet, silver)**
  - PEC: 2725-07S (COL18)
  - Comcode: 103786802
- **Designation Card Cover**
  - PEC: 32309
  - Comcode: 846320216
- **Button Designation Card**
  - Tractor Feed For 25 Sets, 3 Sheets (12 cards per sheet)
  - PEC: 32310
  - Comcode: 847161817

Tractor Feed For 100 Sets, 9 Sheets (12 Cards per Sheet)  
PEC: 32311  
Comcode: 847161916;  
Laser Printer Forms (8 1/2"x11")  
67 Sheets (6 Cards per Sheet)  
PEC: 32312  
Comcode: 847065497

## Adjuncts

---

The following adjuncts can be used with the 8410 voice terminal:

- S101A Speakerphone (no longer orderable)
- S201A Speakerphone
- CS201A Speakerphone
- 7400B Plus Data Module
- 500A Headset Adapter (and a standard headset; see "Headsets" below)
- K6S2 Amplifier Handset
- Shoulder Rest

## Headsets

A list of compatible headsets, consisting of both modular and plug prong base units and selection of headpieces, appears in "Headset Adapters" in the **Adjuncts** section later in this manual.

## Additional Documents

---

The following documents contain additional information relating to the 8410 voice terminal: (Use the 9 digit number listed after each document to order that book from the BCS Publications Center for Lucent Technologies.)

- *8403, 8410, and 8434 Voice Terminals Instructions for Installation, Switch Administration, and Programming the Options*, 555-015-164
- *DEFINITY Communications System Generic 1 and System 75 8410 Voice Terminal User's Guide*, 555-230-763
- *DEFINITY Communications System Generic 1 and 3 and System 75 8410 Quick Reference Guide*, 555-230-764
- *DEFINITY Communications System Generic 2 and System 85 8410 Voice Terminal User's Guide*, 555-104-763
- *DEFINITY Communications System Generic 2 and System 85 8410 Quick Reference Guide*, 555-104-764

# The 8411 Voice Terminal

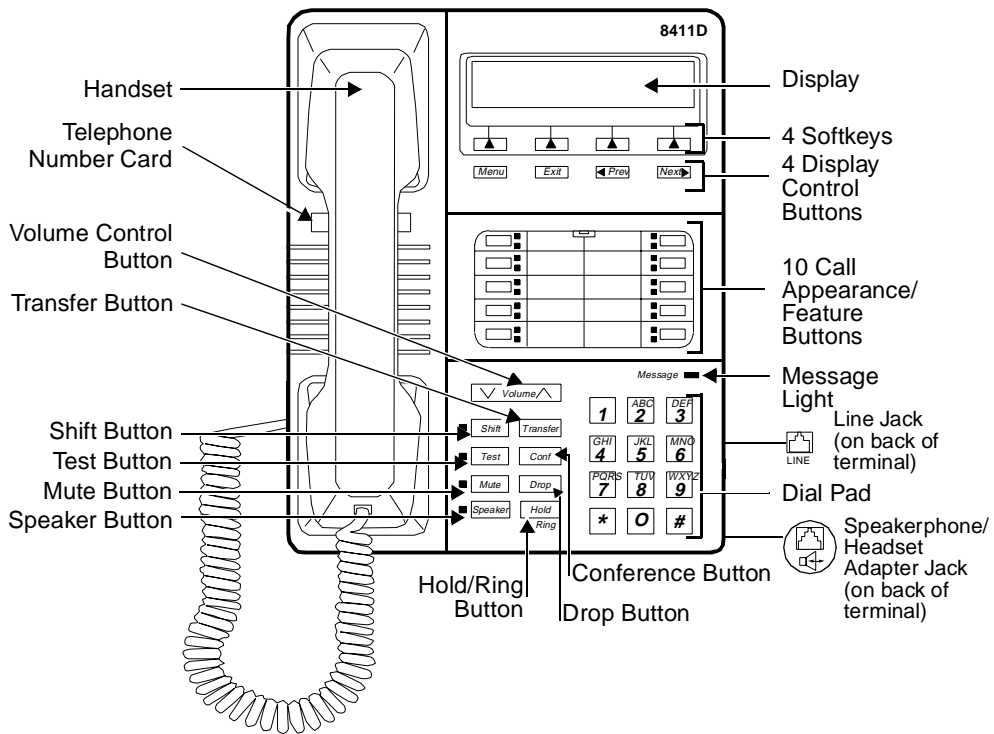

Figure 12-15. The 8411D Voice Terminal (With Display)

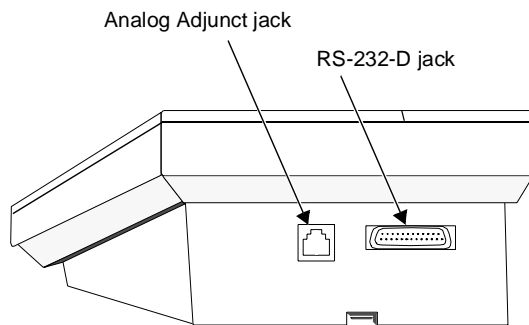

Figure 12-16. The Rear of the 8411 Voice Terminal

The 8411 voice terminal is a multi-appearance digital telephone with 10 call appearance/feature buttons, four standard fixed feature buttons (CONFERENCE, DROP, HOLD, and TRANSFER), a blue SHIFT button, a MUTE button, a SPEAKER button which can access either a 2-way speakerphone or a 1-way, listen-only speaker, a TEST button, and a Volume control button.

The rear of the 8411 voice terminal has two jacks (see Figure 12-16): The Analog Adjunct jack can be used for connecting answering machines, fax machines, PC or laptop data/fax modem cards, data sets or modems, audio teleconferencing equipment, and TTY machines commonly used by the hearing impaired. The RS-232-D Jack can be used for connecting the voice terminal to a COM port on an IBM-compatible personal computer on which you can load PassageWay Solution software.

There are two varieties of the 8411 voice terminal: the 8411B (8411D02A) is the basic set, without a display; the 8411D (8411D01A) has a built-in 2-line by 24-character display. Those users who have an 8411D with display can access 12 features with the softkeys and display control buttons. These 12 features can be used *in addition to* the features on the call appearance/feature buttons.

The 8411 voice terminal can work in both 4-wire and 2-wire environments. For more information, see "Wiring Information."



**NOTE:**

As of September 1, 1998, the 8411B will be discontinued.

## Applications

The 8411 voice terminal can be used with the DEFINITY Communications System Generic 1, Generic 2, and Generic 3, the DEFINITY ECS, System 75, and System 85. This type of voice terminal is especially suitable for managers, executive secretaries, and other office support personnel who require access to multiple

lines for call handling, call coverage, bridging, conferencing, and sophisticated voice communications. The display set can be used by those who have a need for calling party display capabilities or who require a large number of voice terminal features. The jacks on the rear of the set allow connection of a PC for PassageWay connection and an analog device (see the list of possible analog adjuncts above).

The 8411 voice terminals can also provide the user with simultaneous voice and data communications. The 8411 can be connected to a 7400B Plus Data Module or an 8400B Plus Data Module. With the 8411 voice terminal, PC platform products can be useful in providing voice capabilities since these screen-based products can greatly enhance the telephone capabilities of these voice terminals.

## Physical Features

---

### Dimensions



**NOTE:**

The dimensions described here for the 8411 voice terminal are approximate.

Width = 7-3/4 inches

Depth (front to back) = 9-1/2 inches

Height (maximum with handset in place)

The desk-mounted model = 5-1/4 inches

### Features

#### Eight Fixed Feature Buttons

The 8411 has the following eight fixed feature buttons:

- CONFERENCE (labeled CONF) button
- DROP button
- TRANSFER button
- A red HOLD button
- A blue SHIFT button
- MUTE button
- SPEAKER button
- TEST button

## The SHIFT Button

The blue SHIFT button on the set can be used with the HOLD button to select your own personalized ring from among eight available patterns. (The red light next to the SHIFT button goes on steadily when the button is activated.)

## Call Appearance/Feature Buttons

The 8411 voice terminal has 10 call appearance/feature buttons, each equipped with a red light and a green status light. Usually, at least three of these buttons are administered as call appearances for the terminal's primary extension number, where calls are placed and answered. The rest of the buttons can be used for more call appearances (including bridged appearances of other stations' extensions) and features. Buttons administered for features have only their green status lights active.

## Message Light

The red Message light goes on when a message is left for the user. It goes off when the user retrieves the message or when the message is erased.

## Speakerphone

The 8411 voice terminal is equipped with a built-in speakerphone. (The voice terminal can be optioned for a 1-way, listen-only speaker instead.) The Speakerphone capability allows a user to engage in a hands-free conversation with the far-end party. The speakerphone can be turned on or off with the SPEAKER button; can be muted with the MUTE button, and the volume can be raised and lowered with the VOLUME "arrow" button.

## Speaker (Listen-Only) Feature

Although the 8411 voice terminal is shipped from the factory with the terminal set for the Speakerphone feature, the 8411 voice terminal can be optioned instead for a 1-way, listen-only speaker. If this is the case, use the SPEAKER button on the front of the voice terminal for turning on and off the speaker.

The Speaker (listen-only) capability allows a user to engage in a 1-way conversation with the far-end. Specifically, the user can only listen to the far-end. To speak with the far-end, the user must use the handset which turns off the speaker. The Speaker function may also be disabled.

## MUTE Button

The MUTE button is a fixed feature button with a red status light. The MUTE button turns off the microphone of the built-in speakerphone or the handset so that a person can converse with another person in the room without the other party listening in.

## VOLUME Control Button

The 8411 voice terminal has a VOLUME “arrow” button on the front of the set. This button has several functions. When the user is using the speakerphone or the 1-way speaker, the VOLUME button controls the volume of the speaker. When the user is on a call using the handset, the VOLUME button controls the handset volume. When the voice terminal is idle, the button controls the volume of the tone ringer.

When the user sets the volume for the speaker, speakerphone, handset, or the tone ringer, the display on the 8411D voice terminal shows a “bar array” that indicates the volume setting.

## TEST Button

When the voice terminal is initially powered up, the green light next to the TEST button flashes if the link with the PBX is not (or not yet) operational. The light changes to steady green when the voice terminal is able to communicate with the PBX. After the voice terminal is powered up, you can press the TEST button to test the lights and the display on your voice terminal.

## Display

The display on the 8411D set has two lines with 24 characters on each line. The display, along with the softkeys and the display control buttons, can be used to access 12 softkey features (the default softkey features and the alternative softkey features are listed under “Softkeys”).

## Display Control Buttons

These four buttons are labeled **Menu**, **Exit**, **◀ Prev**, and **Next ▶**.

- **Menu** is used to enter Softkey Mode and access the 12 softkey features.
- **Exit** is used for exiting a display feature and returning to Normal (call-handling) Mode.
- **◀ Prev** and **Next ▶** can be used to help you go back and forth through the feature option screens.

## Softkeys

The four buttons located below the display and labeled with arrows correspond to features listed on the second line of the display screen. (There are four features on each feature option screen.) The user can access any of the 12 features by pressing the softkey below the feature abbreviation.

Below is a list of the 12 default softkey features assigned to the 8411 and the order in which they appear.

**Table 12-16. Default Softkey Features on the 8411D**

Abbreviation	Feature
<b>First Screen LWC</b>	Leave Word Calling
<b>CnLWC</b>	Cancel Leave Word Calling
<b>AutCB</b>	Automatic Callback
<b>Timer</b>	Timer
<b>Second Screen CFrwd*</b>	Call Forward
<b>CPark†</b>	Call Park
<b>TmDay</b>	Time/Date
<b>PCall</b>	Priority Calling
<b>Third Screen Prog</b>	Abbreviated Dialing Program
<b>Pause</b>	Abbreviated Dialing Special Function Pause
<b>Mark</b>	Abbreviated Dialing Special Function Mark
<b>Wait</b>	Abbreviated Dialing Special Function Wait

\* On a DEFINITY Generic 2 or on a System 85, this feature is named Call Forward - Follow Me.

† On a DEFINITY G2 and on a System 85, there is no Call Park feature that can be assigned to a feature button. In order to have the Call Park function on a softkey or hard button, administer the button as an Abbreviated Dial button and program the Call Park trunk group access code onto it. This button can then be labeled "Call Park." In addition, on a DEFINITY G2 or a System 85, the Recall feature must be administered on a standard feature button.

On 8411D voice terminals (8411 terminals with a display) connected to a DEFINITY G3V3 or later, the System Manager can choose to administer alternate features for use with the softkeys. The following table lists some of the alternate softkey features that can be substituted for the default softkey features listed on the previous page.

**⇒ NOTE:**

The DEFINITY ECS Release 5 (and later releases) may provide additional alternate softkey features.

**⇒ NOTE:**

With G3V3 and later switches, the system can download *BLANK* softkey labels for positions where there are no features administered.



**Table 12-17. Alternate Softkey Features on the 8411D Connected to a DEFINITY G3V3 and Later**

Abbreviations	Feature
<b>AD</b>	Abbreviated Dialing buttons (can be multiple AD buttons)
<b>Cnslt</b>	Consult
<b>Count</b>	ACD Stroke Count
<b>CPkup</b>	Call Pickup
<b>Dir*</b>	Directory
<b>Excl</b>	Manual Exclusion
<b>HFAns†</b>	Internal Auto Answer
<b>IAuto</b>	Intercom Auto
<b>IDial</b>	Intercom Dial
<b>Inspt</b>	Inspect
<b>Last</b>	Last Number Dialed
<b>RngOf</b>	Ringer Off
<b>SAC</b>	Send All Calls
<b>SFunc</b>	Abbreviated Dialed Special Function
<b>Spres</b>	Abbreviated Dialing Special Function Suppress
<b>Stats</b>	View (ACD) Statistics
<b>Stop</b>	Abbreviation Dialing Indefinite Wait or Stop
<b>View‡</b>	Stored Number

\* A CALL DISPLAY button should be administered, if access to System Directory is provided. It is also desirable for a NEXT DISPLAY button to be administered. This feature is *not* available on a DEFINITY G2 or System 85.

† This feature is available only on a DEFINITY G3V2 (or later) switches.

‡ This feature is *not* available on a DEFINITY G2 or System 85.

## **Other Physical Features**

### **Handset**

The 8411 voice terminal is equipped with a K-type handset.

### **Dial pad**

The 8411 voice terminal is equipped with a 12-button touch-tone dial pad. The letters "Q" and "Z" have been added to the appropriate dial pad keys for directory access, and the "5" button on the dial pad has raised bars for visually-impaired users.

### **Jacks**

The 8411 voice terminal's housing has a Line jack located on the back of the housing, and a Handset cord jack located on the side of the set. There is also a Speakerphone/headset adapter jack to which the user can connect adjunct equipment.

The Analog Adjunct jack on the rear of the 8411 voice terminal can be used for connecting answering machines, fax machines, PC or laptop data/fax modem cards, data sets or modems, audio teleconferencing equipment, and TTY machines commonly used by the hearing impaired. The RS-232-D Jack also on the rear of the voice terminal can be used for connecting the voice terminal to a COM port on an IBM-compatible personal computer on which you can load PassageWay Solution software.

### **Cords**

Two cords are supplied with the 8411: a coiled 9-foot handset cord and a 7-foot line cord.

Optional longer cords are available: a 12-foot handset cord and 14-foot and 25-foot line cords.

### **Ringling**

The 8411 voice terminal has electronic tone ringling with eight possible ringling patterns that can be selected with the SHIFT button and the HOLD button. The loudness of the tone ringer can be controlled by the VOLUME "arrow" button. (The user must NOT be on a speakerphone call. If the user is using the speakerphone, the VOLUME "arrow" button controls the volume of the speakerphone.)

### **Mounting Options**

The 8411 voice terminal comes equipped with a 2-position desk stand. The 8411 cannot be wall-mounted.

### **Color Options**

The 8411 voice terminal is available in black and in white.

## PassageWay and Analog Adjunct Connections

### Connecting the 8411 to a Personal Computer for PassageWay Applications

The RS-232-D jack on the 8411 voice terminal provides the user with a direct interface between an IBM-compatible personal computer and a DEFINITY switch. This connection with the PC allows access to Lucent Technologies PassageWay Solution applications.

For information about installing and setting up the PassageWay software, see the *PassageWay-Direct Connection Solution For DEFINITY Communications System 8411 Voice Terminal User's Guide*, 555-201-115.

#### NOTE:

In order for the 8411 voice terminal to operate, the voice terminal must have auxiliary power, either locally using an 1151A1 power supply or 1151A2 power supply with Battery Holdover or remotely using an 1145B1 closet supply. Also, before the PassageWay connection can be set up, the exact COM port number (that is, COM1, COM2, COM3, or COM4) to which the 8411 voice terminal is being connected must be identified.

### Connecting an Analog Adjunct to the 8411 Voice Terminal

Through the Analog Adjunct RJ11C jack on the rear of the set, the 8411 voice terminal provides connection with Analog Adjuncts such as answering machines, fax machines, PC or laptop data/fax modem cards, data sets or modems, audio teleconferencing equipment, and TTY machines commonly used by the hearing impaired. On System 75, System 85, and DEFINITY G1 and G2 and DEFINITY G3 prior to G3V4, Issue 3, the analog equipment shares the telephone line (or I1-Channel) with the voice terminal. Therefore, while the telephone is being used, you *cannot* use the Analog Adjunct at the same time, or vice versa. Beginning with the DEFINITY G3V4, Issue 3 (and all later releases), the 8411 and Analog Adjunct can use separate telephone lines (the I1-Channel and I2-Channel) and thus the voice terminal and the Analog Adjunct can be used simultaneously.

### The PassageWay Button (Button #9) and the Analog Adjunct Button (Button #10)

The system manager may choose to option Button #9 on the 8411 voice terminal, the next-to-last button in the second column, (see Figure 12-17 for the location of this button) so that the red and green lights next to the button provide PassageWay status information. (See "PassageWay Status Indications" later in this section on the 8411.) If Button #9 is optioned in this manner, it is then disabled and CANNOT be used as a call appearance button or feature button.

The system manager may also choose to option Button #10 (again, see Figure 12-17 below for its location) so that its adjacent red and green lights provide Analog Adjunct status information. (See “Analog Adjunct Status Indications” later in this section on the 8411.) If Button #10 is optioned in this way, the button’s function changes from a call appearance/feature button to a local button that can be used to send a disconnect signal to the analog adjunct. (See “Sharing the 8411 Telephone Line with the Analog Adjunct” later in this section on the 8411.)

**NOTE:**

When the status indication feature is optioned, Button #9 is always used to monitor the PassageWay connection, and Button #10 is always used to monitor the Analog Adjunct. No other buttons on the 8411 can be used for these purposes. If these two buttons are not used for PassageWay and an Analog Adjunct, they can be used for switch features.

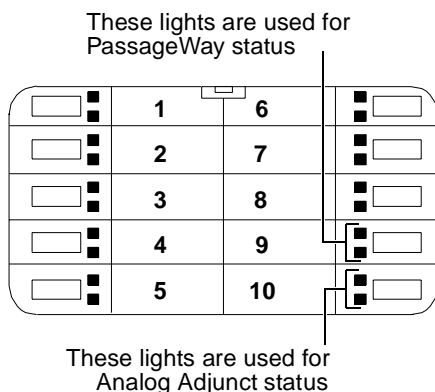

Figure 12-17. The Location of Buttons #9 and #10 on the 8411

### PassageWay Status Indications

The 8411 provides the following status indications, next to Button #9 for the PassageWay connection:

**Table 12-18. PassageWay Status Indications on the 8411 Voice Terminal**

PassageWay Status	Green light	Red light
AT Command Mode	Off	On
PassageWay Mode	On	Off
DCP Looparound	Flash*	Flash
Switch Link Down	Wink†	Wink
EIA Out-of-Sync	Flash	Off
Program Mode	On	Flash

\* A *Flash* is a repeating pattern of 500 ms ON and 500 ms OFF.

† A *Wink* is a repeating pattern of 750 ms ON and 250 ms OFF.

### Analog Adjunct Status Indications

The 8411 uses the GREEN and the RED lights next to Button #10 to provide the following status indications for the Analog Adjunct connection.

**Table 12-19. Analog Adjunct Status Indications on the 8411 Voice Terminal**

Analog Adjunct Status	Green Light	Red Light
The Analog Adjunct is off-hook.	On	
The Analog Adjunct is on-hook and idle.	Off	
The voice terminal is sending a Flash ringing signal to the Analog Adjunct.	Flash	
The Analog Adjunct is using the telephone line.		On
The 8411 voice terminal is using the telephone line (that is, the Analog Adjunct is NOT using the I-Channel).		Off



**NOTE:**

The flash indication has priority over the on-hook and off-hook indications listed immediately above.

 **NOTE:**

When the 8411 is programmed for the Analog Adjunct to use a separate telephone line (that is, the I2-Channel), the red light is always on.

### Sharing the 8411 Telephone Line with the Analog Adjunct

When your 8411 voice terminal has not been assigned a separate telephone number for your analog adjunct, that is, the telephone line must be shared between your voice terminal and the analog adjunct connected to the Analog Adjunct jack, you CANNOT use your 8411 and the analog adjunct at the same time. If you desire to use your 8411 (the handset, the built-in speakerphone, or any equipment connected to the Speakerphone/Headset jack) while the analog adjunct is using the line, you must first disconnect from the analog adjunct call.

You may disconnect from the analog adjunct call manually using a button on the analog adjunct or use a PC command if the analog adjunct is connected to the PC. Button #10 can also be used to disconnect the call on the analog adjunct if that button has been enabled for the disconnect function.

In addition to the manual and Button #10 methods for disconnecting from the analog adjunct call, going off-hook and pressing the appropriate call appearance button will also cause the line to be switched to the voice terminal (handset, speakerphone, or any equipment connected to the Speakerphone/ Headset jack) and a disconnect signal will be sent to the analog adjunct. This method allows you to automatically disconnect the analog adjunct to:

- Answer an incoming call on another call appearance
- Originate a call on an idle call appearance
- Interrupt the analog adjunct and use the active call appearance

 **NOTE:**

This feature requires the 8411 to use the first three call appearance/feature buttons (the top three buttons in the first column) as call appearance buttons. If there are more than three call appearance buttons administered, the feature will still work with these (top) three buttons, but NOT with the additional call appearance buttons.

For incoming calls, the device that answers first (that is, the 8411 handset, 8411 built-in speakerphone, any equipment connected to the Speakerphone/ Headset jack on the 8411, or the analog adjunct connected to the 8411 Analog Adjunct jack) gets control of the call. Note that not all incoming calls will cause a ringing signal to be sent to the analog adjunct. A ringing signal will be sent only if all call appearances are idle and the incoming call is either an inside call, a DID call, or a Priority call.

## Wiring Information

---

The 8411 voice terminal works in both 4-wire and 2-wire DCP configurations. The table below describes the pins on an 8400-Series voice terminal LINE jack.

**Table 12-20. The Pins on an 8400-Series Voice Terminal LINE Jack**

Line Interface			
Pin	Pair	Name	Description
1	2	OD1	4-Wire Output
2	2	OD2	4-Wire Output
3	3	ID1	4-Wire Input
4	1	U-T	2-Wire (Tip)
5	1	U-R	2-Wire (Ring)
6	3	ID2	4-Wire Input
7	4	P1-	Adjunct Power -48V
8	4	P2+	Adjunct Power Common

---

### NOTE:

Regardless of which configuration is in use, ALL wiring between the PBX and the terminal MUST consist of twisted-pairs, including the modular line cord. The line cord must be a D8W, which consists of 4 twisted-pairs, or a Lucent Technologies-approved equivalent.

Twisted-pair wiring is used to make lines less sensitive to crosstalk. Therefore, failure to use twisted pair wiring may result in less-than-optimum performance of the terminal and may also contribute to problems with the line.

An 8-wire modular cord MUST be used for all 4-wire and any 2-wire installations requiring auxiliary power.

### NOTE:

You do NOT need to change any settings on the voice terminal for 2-wire or 4-wire installations. The voice terminal is able to detect whether it is in a 2-wire or a 4-wire configuration.

For 2-wire operation, if you need to plug the voice terminal into a 4-pin or 6-pin wall jack, instead of a standard 8-pin modular jack, refer to the "Line Interface" table to insure that the wires from the 4-pin or 6-pin wall jack are connected to the correct pins on the terminal "LINE" jack.

In order for the terminal to function properly in either 2-wire or 4-wire installations, there must be NO INTERCONNECTIONS between the wire pairs used for 2-wire and 4-wire operations. Bridging or paralleling of these pairs can result in damage to the terminal or can cause the PBX circuit pack to remove power to the terminal.

REMOVE ALL CONNECTIONS BETWEEN PAIRS BEFORE CONNECTING THE TERMINAL.

4-WIRE installations MUST ONLY have PBX connections on pair 2 and pair 3 and, if necessary, auxiliary power must be connected to pair 4.

2-WIRE installations MUST ONLY have PBX connections on pair 1 and, if necessary, auxiliary power must be connected to pair 4.

## Distance Limitations

---

The following circuit packs can be used with all of the 8400-Series sets.

**Table 12-21. Circuit Packs Used with the 8400-Series Voice Terminals**

Circuit Pack	2/4-Wire	Will support these switches
TN2181 - 16-port	2-wire	G3V3, G3V2
TN754b - 8-port	4-wire	All switches except System 85
TN754 - 8-port	4-wire	All switches except System 85
TN413 - 8-port	4-wire	International System 75
SN 270 and SN 270B - 4-port	4-wire	System 85 R2V2 - R2V4

**In 4-wire operation**, the voice terminal must be within 5,000 feet of the PBX using 22-gauge or 24-gauge wire, and within 4,000 feet of the PBX using 26-gauge wire.

**In 2-wire operation**, the voice terminal must be within 5,500 feet of the PBX using 22-gauge wire, within 3,500 feet of the PBX using 24-gauge wire, and within 2,200 feet of the PBX using 26-gauge wire.

## Power Requirements

---

In order for the 8411 voice terminal to operate, the voice terminal must have auxiliary power, either locally using an 1151A1 power supply or 1151A2 power supply with Battery Holdover or remotely using an 1145B1 closet supply. Refer to the **Adjunct Power** section earlier in this manual for information on these power supplies.



**Switch Administration**

---

**Aliasing**

Use the following table for administering the 8411B (the basic) voice terminal:

**Table 12-22. Administering the 8411B Voice Terminal**

<b>If you have this System</b>	<b>and this Release</b>	<b>(which can support this type of operation)</b>	<b>Administer the 8411B as a</b>
System 75	R1V1 — R1V3	4-wire only	7403D
System 85	R2V2 — R2V4	4-wire only	7403D
International System 75	IR1V4, etc.	4-wire only	7403D
DEFINITY G1		4-wire only	7403D
Global DEFINITY '91		4-wire only	7410D
DEFINITY G2V1		4-wire only	7410D
DEFINITY G2V2		4-wire only	7410D
DEFINITY G3i, G3r, G3s, G3vs		4-wire only	7410D
DEFINITY G3V2		2- or 4-wire	7410D
DEFINITY G3V3 and later		2- or 4-wire	8410B

Use this table for administering the 8411D (with display) voice terminal:

**Table 12-23. Administering the 8411D Voice Terminal**

<b>If you have this System</b>	<b>and this Release</b>	<b>(which can support this type of operation)</b>	<b>Administer the 8411D as a</b>
System 75	R1V1 — R1V3	4-wire only	7405D+D
System 85	R2V2 — R2V4	4-wire only	7405D+D
International System 75	IR1V4, etc.	4-wire only	7405D+D
DEFINITY G1	R1V4	4-wire only	7405D+D
Global DEFINITY '91		4-wire only	7405D+D
DEFINITY G2V1		4-wire only	7405D+D
DEFINITY G2V2		4-wire only	7405D+D
DEFINITY G3i, G3r, G3s, G3vs		4-wire only	7405D+D
DEFINITY G3V2		2- or 4-wire	7405D+D
DEFINITY G3V3 and later		2- or 4-wire	8410D

### **Button Numbering**

The following button diagrams of the 8411 voice terminal will help you administer both of these voice terminals connected to a System 75, a DEFINITY G1 and G3, or a DEFINITY ECS, and to a System 85 or a DEFINITY G2.

Figure 12-18 shows button numbering for the 8411 connected to a System 75, DEFINITY G1 and G3, or a DEFINITY ECS. Figure 12-19 shows button numbering for the 8411 connected to a System 85 or DEFINITY G2.

If you need more information, refer to *DEFINITY Communications System Generic 3 Implementation*, 555-230-653, and *DEFINITY Communications System Generic 2 Administration of Features and Hardware*, 555-104-507.

If the 8411D is administered as a 7405D, administer the 12 softkey features on "FEATURE BUTTON ASSIGNMENTS" 2 through 13; administer the Normal feature on Button #1.

If the 8411D is administered as an 8410D, administer the 12 softkey features on "SOFTKEY BUTTON ASSIGNMENTS" 1 through 12.

The 10 call appearance/feature buttons are administered as "BUTTON ASSIGNMENTS" 1 through 10.

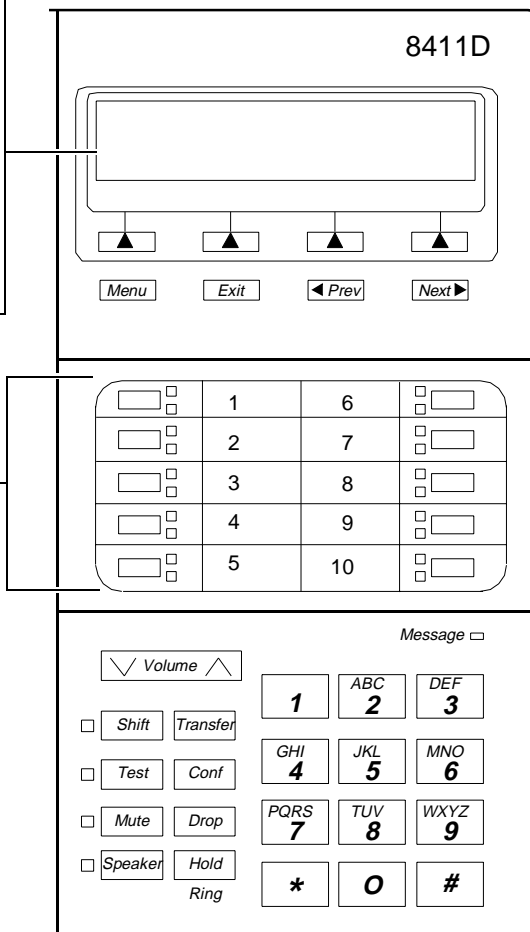

Figure 12-18. Button Numbering for Administering the 8411 Voice Terminal Connected to a System 75, a DEFINITY G1 or G3, or a DEFINITY ECS

If the 8411D is administered as a 7405D, administer the 12 softkey features on "FEATURE BUTTON ASSIGNMENTS" 14 through 25; administer the Normal feature on Button #13.

If the 8411D is administered as an 8410D, administer the 12 softkey features on "SOFTKEY BUTTON ASSIGNMENTS" 1 through 12.

The 10 call appearance/feature buttons are administered as "BUTTON ASSIGNMENTS" 3 through 12.

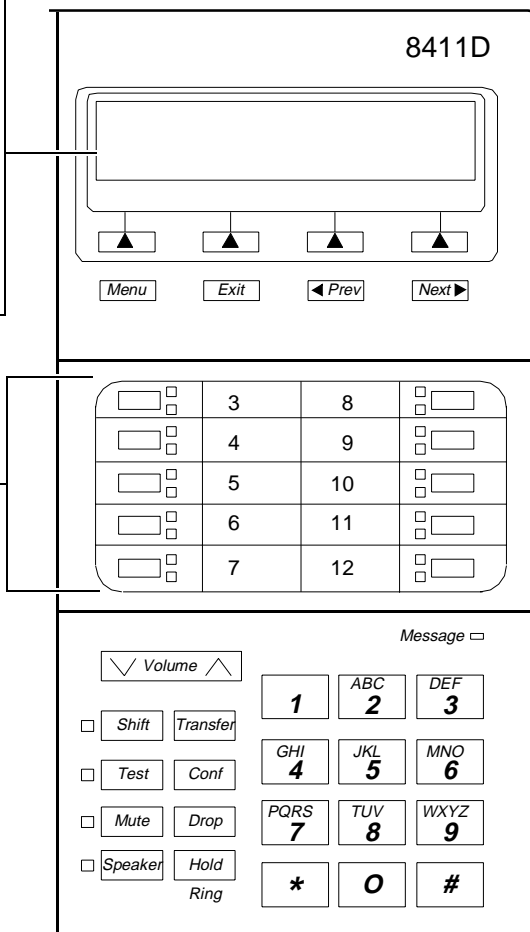

Figure 12-19. Button Numbering for Administering the 8411 Voice Terminal Connected to a System 85 or a DEFINITY G2

### Administering the Analog Adjunct

As noted in **Table 12-22** and **12-23**, the 8411D can be administered as itself ONLY IF it is connected to a DEFINITY G3V4, Issue 3 (or later) switch. In Native Mode the voice terminal is administered through a digital line circuit card with a line number (with the usual three call appearances) assigned to the I-1 Channel. A second line number can be administered through the same digital line card on the I-2 Channel, but this line number can only be used for analog adjuncts connected to the Analog Adjunct jack on the 8411. This Analog Adjunct is assigned a private number, but can be used only for placing or terminating a call.

**12** The 8400 Series Voice Terminals  
*The 8411 Voice Terminal*

12-69

It cannot be used for any other analog functions such as transferring a call or setting up a conference call. If a second line on the 8411 is administered on the I-2-Channel (for analog equipment) on the 8411, type "analog" in the **Data Option** field on the administration screen.

## **Power Failure Operation**

---

The 8411 voice terminal cannot be used as an emergency station during power failure transfer conditions.

## **FCC Registration**

---

The 8411 voice terminal is FCC-registered along with the switch (as a system), but does not have a separate FCC registration label.

## **UL and CSA Approval**

---

The 8411 voice terminal has been tested and has met the Underwriters Laboratories (UL) Standards UL 1459 and has also met the Canadian Standards Association (CSA) Standards CSA-C22.2 No.225-M90.

## **Hearing Aid Compatible**

---

The 8411B and 8411D voice terminals are compatible with the inductively coupled hearing aids prescribed by the FCC.

## **8411 Equipment PECs and Comcodes**

---

The 8411B and 8411D voice terminals and components can be ordered with these PECs and Comcodes:

- **Basic 8411B (8411D02A) Voice Terminal**  
Black 8411B Set PEC: 3234-TRB with power supply PEC: 3234-PTB  
Comcode: 107526535;  
White 8411B Set PEC: 3234-TRW with power supply PEC: 3234-PTW  
Comcode: 107526543
- **8411D (8411D01A) Voice Terminal (with built-in display)**  
Black 8411D Set PEC: 3235-TRB with power supply PEC: 3235-PTB  
Comcode: 107526501;  
White 8411D Set PEC: 3235-PTW with power supply PEC: 3234-PTW  
Comcode: 107526519
- **K2S6 Handset**  
Comcode: Black=107180549; White=107181471
- **K6S2-003 (Black) Amplifier Handset**  
Comcode: 105581896

12 The 8400 Series Voice Terminals  
The 8411 Voice Terminal

12-70

- **Handset cord (9 feet)**  
Comcode: Black=105635429; White=105701809
- **Line cord (7 feet)**  
Comcode: 103786778
- **Line cord (14 feet, silver)**  
PEC: 2725-07N (COL18)  
Comcode: 103786828
- **Line cord (25 feet, silver)**  
PEC: 2725-07S (COL18)  
Comcode: 103786802
- **Designation Card Cover**  
PEC: 32309  
Comcode: 846320216
- **Button Designation Card**  
Tractor Feed For 36 Sets, 3 Sheets (12 cards per sheet)  
PEC: 32310  
Comcode: 847161817;  
Tractor Feed For 108 Sets, 9 Sheets (12 cards per sheet)  
PEC: 32311  
Comcode: 847161916;  
Laser Printer Forms (8 1/2"x11")  
67 Sheets (6 cards per sheet)  
PEC: 32312  
Comcode: 847065497
- **PassageWay connection software, documentation, and cables**  
PEC: 8302-800  
Comcode: 407504646

## Adjuncts

---

The following adjuncts can be used with the 8411 voice terminal:

- S101A Speakerphone (no longer orderable)
- S201A Speakerphone
- CS201A Speakerphone
- 7400B Plus Data Module
- 8400B Plus Data Module
- 500A Headset Adapter (and a standard headset;  
see "Headsets" below)
- K6S2 Amplifier Handset
- Shoulder Rest

12 The 8400 Series Voice Terminals  
    *The 8411 Voice Terminal*

12-71

## Headsets

A list of compatible headsets, consisting of both modular and plug prong base units and selection of headpieces, appears in "Headset Adapters" in the **Adjuncts** section later in this manual.

## Additional Documents

---

The following documents contain additional information relating to the 8411 voice terminal: (Use the 9 digit number listed after each document to order that book from the BCS Publications Center for Lucent Technologies.)

- *The 8400-Series Voice Terminals Instructions for Installation, Switch Administration, and Programming the Options*, 555-015-725
- *DEFINITY Communications System Generic 1 and System 75 8411 Voice Terminal User's Guide*, 555-230-872
- *DEFINITY Communications System Generic 1 and 3 and System 75 8411 Quick Reference Guide*, 555-230-873
- *DEFINITY Communications System Generic 2 and System 85 8411 Voice Terminal User's Guide*, 555-104-769
- *DEFINITY Communications System Generic 2 and System 85 8411 Quick Reference Guide*, 555-104-770

## The 8434 and 8434DX Voice Terminals

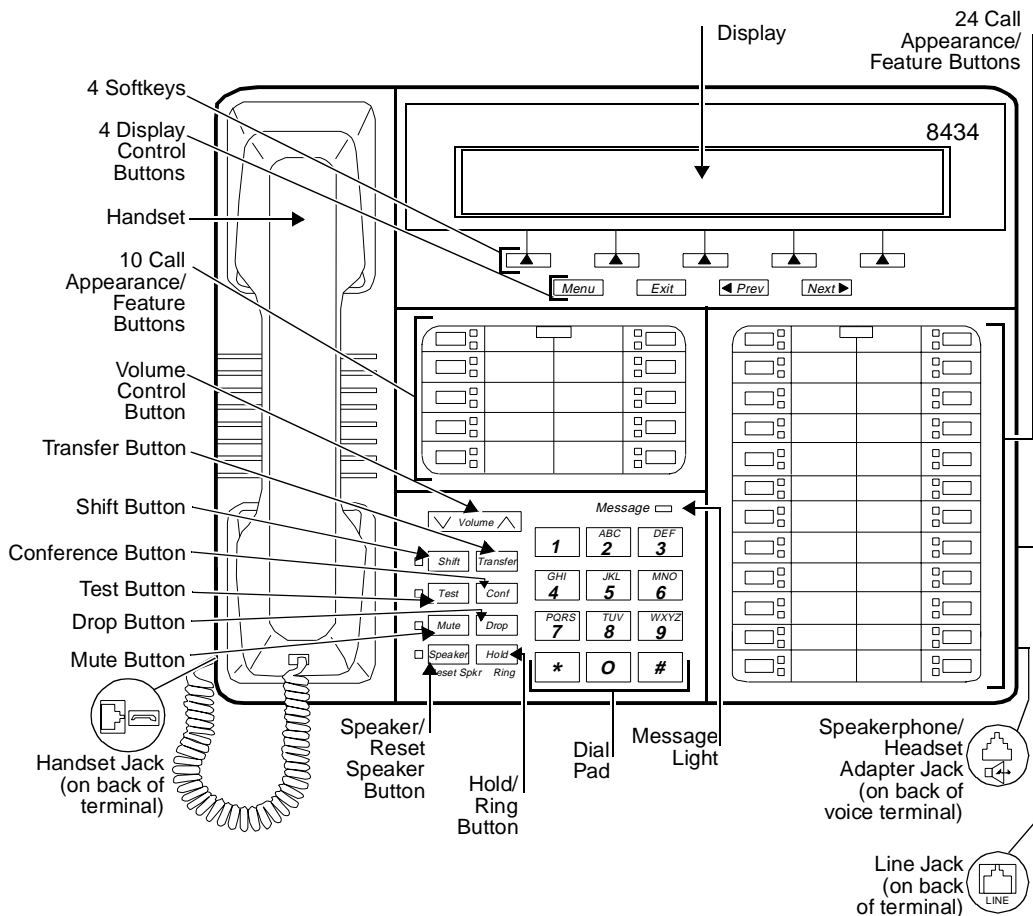

Figure 12-20. The 8434 Voice Terminal



12 The 8400 Series Voice Terminals  
The 8434 and 8434DX Voice Terminals

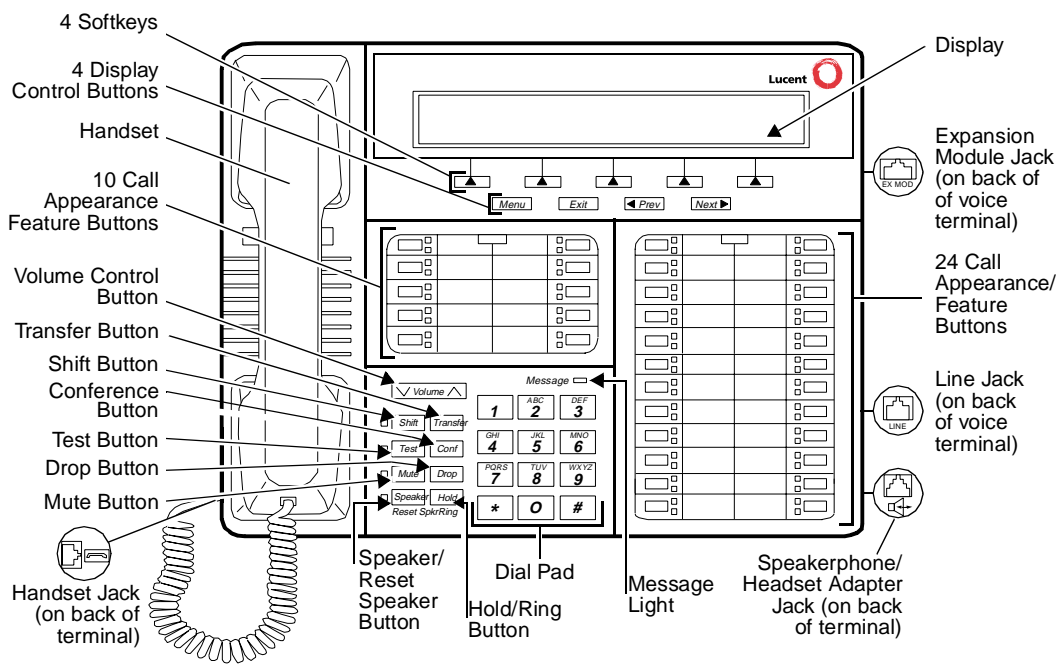

Figure 12-21. One Version of the 8434DX Voice Terminal

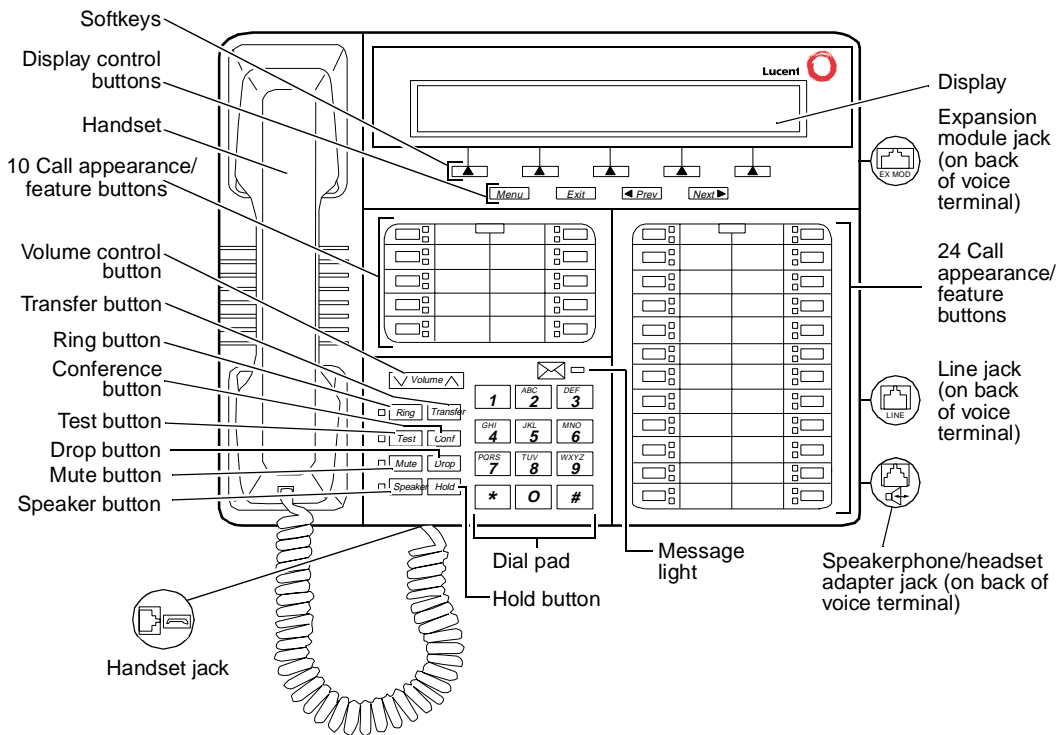

Figure 12-22. Another Version of the 8434DX Voice Terminal

The basic 8434 (8434D01A) and the enhanced 8434DX (8434D02A) voice terminals are multi-appearance digital voice terminals which offer 34 call appearance/feature buttons, each with a red light and a green status light, four standard fixed feature buttons (CONFERENCE, DROP, HOLD, and TRANSFER), a MUTE button, a SPEAKER button which accesses either a 2-way speakerphone or a 1-way listen-only speaker, a TEST button, a SHIFT button (some 8434DX voice terminals will have a RING button instead), a red Message light, personalized ringing, a built-in speakerphone with a reset option, and a built-in 2-line by 40-character VFD display. The 8434 and 8434DX also have five softkeys and four display control buttons which allow the user to access 15 features. These softkey features can be used *in addition to* the features on the call appearance/feature buttons.

The 8434 and 8434DX voice terminals can be used in both a 4-wire and a 2-wire environment. For more information, see "Wiring Information."

**NOTE:**

In order to use the display on the 8434 or 8434DX voice terminal and to use an 801A expansion module connected to the 8434DX, you must connect an

12 The 8400 Series Voice Terminals  
*The 8434 and 8434DX Voice Terminals*

12-75

auxiliary power supply to the voice terminal. Recommended are an 1151A1 local power supply or an 1151A2 power supply with Battery Holdover.

The 801A Expansion Module can be connected to the 8434DX voice terminal to provide 24 additional call appearance/feature buttons. The 801A can be used ONLY with the 8434DX voice terminal and the terminal must be connected to a DEFINITY G3V3.3 (or later release). For more information about this module, see the section on the 801A Expansion Module behind the tab labeled **Adjuncts**.



**NOTE:**

The basic 8434 (8434D01A) voice terminal is no longer manufactured.

## Applications

---

The 8434 and 8434DX voice terminals can be used with the DEFINITY Communications System Generic 1, Generic 2, or Generic 3, the DEFINITY ECS, System 75, or System 85. These terminals are appropriate terminals for users who handle numerous calls and who need button access to a wide variety of features. For example, the 8434 and 8434DX voice terminals, with their large number of administrable buttons, can use the Abbreviated Dialing feature for reaching many frequently called parties. The buttons of the 8434 and 8434DX voice terminals can also be assigned for bridging calls at other stations. Typical users are secretaries, managers, salespeople, buyers, answering groups, and call covering positions.

The 8434 and 8434DX voice terminals can also provide the user with simultaneous voice and data communications. The 8434 and 8434DX can be connected to a 7400B Plus Data Module in a 4-wire environment, or to an 8400B Plus Data Module in a 2-wire environment. With the 8434 and 8434DX voice terminals, PC platform products can be useful in providing voice capabilities since these screen-based products can greatly enhance the telephone capabilities of these voice terminals.

## Physical Description

---

### Dimensions



**NOTE:**

The dimensions given here for the 8434 and 8434DX voice terminals are approximate.

Width = 12.5 inches

Depth (front to back) = 10.25 inches

Height (maximum with handset in place) = 5.6 inches

## Features

### Eight Fixed Feature Buttons

- CONFERENCE (labeled CONF) button
- DROP button
- TRANSFER button
- A red HOLD button
- Either a blue SHIFT button or a RING button
- MUTE button
- SPEAKER button
- TEST button

### The SHIFT Button

All 8434 voice terminals have a blue SHIFT button. Some 8434DX voice terminals have a blue SHIFT button; others have a RING button. (See the description below.) The SHIFT button can be used in two different ways: (The red light next to the SHIFT button goes on steadily when the button is activated.)

- Used with the HOLD button to select your own personalized ringing patterns from among eight available patterns
- Used with the SPEAKER button to perform an acoustic test of the environment and adjust the speakerphone to the surrounding acoustic environment for optimal performance

### The RING Button

On other 8434DX voice terminals, the user can press the RING button in order to select a personalized ringing pattern for the voice terminal. There are eight ringing patterns from which to choose.

### Call Appearance/Feature Buttons

The 8434 and 8434DX voice terminals have 34 call appearance/feature buttons, each equipped with a red light and a green status light. Usually, at least three of these buttons are administered as call appearances for the terminal's primary extension number, where calls are placed and answered. The rest of the buttons can be used for more call appearances (including bridged appearances of other stations' extensions) and features. Buttons administered for features have only their green status lights active.

### Message Light

The red Message light goes on when a message is left for the voice terminal user. The light goes off when the user retrieves the message or when the message is erased. This light is labeled either *Message* or .

## Speakerphone (Listen and Speak) Feature

The 8434 and 8434DX voice terminals are equipped with a built-in speakerphone. The Speakerphone capability allows a user to engage in a hands-free 2-way conversation with the far-end party. The speakerphone can be turned off or on with the SPEAKER button, can be muted with the MUTE button, and the volume can be controlled with the VOLUME “arrow” button.

If the voice terminal has a SHIFT button and *Rest Spkr* appears below the SPEAKER button, the user can access the Reset Speakerphone feature to adjust the speakerphone for optimal performance.

### NOTE:

If there is not a SHIFT button and Reset Spkr does NOT appear under the SPEAKER button, the voice terminal will adjust to the surrounding environment by itself. The user does not need to do anything manually.

By pressing the SHIFT button and then the SPEAKER button (if the voice terminal is set for the Speakerphone feature), the user hears a set of tones as the speakerphone performs an acoustic test of the environment. When the tones stop, the speakerphone has finished adjusting itself and is ready for use. The user should reset the speakerphone whenever the voice terminal is moved to another place (even in the same room), whenever the red light next to the SPEAKER button is fluttering, and in the unlikely event that the speakerphone is making a squealing sound (in this last case, tones will not be heard during a call).

## Speaker (Listen-only) Feature

Although the 8434 and 8434DX voice terminals are shipped from the factory with the terminal set for the Speakerphone feature, the 8434 and 8434DX voice terminals can be optioned instead for a 1-way, listen-only speaker. If this is the case, use the SPEAKER button on the front of the voice terminal for turning on and off the speaker.

The Speaker (listen-only) capability allows a user to engage in a 1-way conversation with the far-end. Specifically, the user can only listen to the far-end. To speak with the far-end, the user must use the handset which turns off the speaker. The Speaker function may also be disabled.

## MUTE Button

The MUTE button disables the transmitter of the speakerphone or the handset depending on which is activated at that time. A red light next to the MUTE button goes on when the Mute feature is activated.

## VOLUME Control Button

The 8434 and 8434DX voice terminals have a VOLUME “arrow” button. This button has several functions. When the user is on a call using the speaker or speakerphone, the VOLUME button controls the volume of the speaker or

speakerphone, whichever is being used. When the user is on a call using the handset, the VOLUME button controls the handset volume. When the voice terminal is idle, the VOLUME control button adjusts the tone ringer.

When the user sets the volume for the speaker, speakerphone, handset, or the tone ringer, the display on the voice terminal shows a “bar array” that indicates the volume setting.

## TEST Button

When the voice terminal is initially powered up, the green light next to the TEST button flashes if the link with the PBX is not (or not yet) operational. The light changes to steady green when the voice terminal is able to communicate with the PBX. After the voice terminal is powered up, you can press the TEST button to test the lights and the display on your voice terminal.

## Display

The 8434 and 8434DX voice terminals are equipped with a built-in, 2-line by 40-character VFD display.

## Display Control Buttons

These four buttons are labeled **Menu**, **Exit**, **◀ Prev**, and **Next ▶**.

- **Menu** is used to enter Softkey Mode and access the 15 softkey features.
- **Exit** is used for exiting a display feature and returning to Normal (call-handling) Mode.
- **◀ Prev** and **Next ▶** can be used to help you go back and forth through the feature option screens.

## Softkeys

The five buttons located below the display and labeled with arrows correspond to features listed on the second line of the display screen. (There are five features on each feature option screen.) The user can access any of the 15 features by pressing the softkey below the feature abbreviation.

**12** The 8400 Series Voice Terminals  
The 8434 and 8434DX Voice Terminals

12-79

Below is a list of the 15 default softkey features assigned to the 8434 and 8434DX and the order in which the features appear.

**Table 12-24. Default Softkey Features on the 8434 and 8434DX**

Abbreviation	Feature
<b>First Screen LWC</b>	Leave Word Calling
<b>CnLWC</b>	Cancel Leave Word Calling
<b>Cnslt</b>	Consult
<b>AutCB</b>	Automatic Callback
<b>Timer</b>	Timer
<b>Second Screen CFrwd*</b>	Call Forward
<b>CPark†</b>	Call Park
<b>Excl</b>	Manual Exclusion
<b>TmDay</b>	Time/Date
<b>PCall</b>	Priority Calling
<b>Third Screen Prog</b>	Abbreviated Dialing Program
<b>Pause</b>	Abbreviated Dialing Special Function Pause
<b>Spres</b>	Abbreviated Dialing Special Function Suppress
<b>Mark</b>	Abbreviated Dialing Special Function Mark
<b>Wait</b>	Abbreviated Dialing Special Function Wait

\* On a DEFINITY Generic 2 or a System 85, this feature is named Call Forward - Follow Me.

† On a DEFINITY G2 and a System 85, there is no Call Park feature that can be assigned to a feature button. In order to have the Call Park function on a softkey or hard button, administer the button as an Abbreviated Dial button and program the Call Park trunk group access code onto it. This button can then be labeled "Call Park." In addition, on a DEFINITY G2 or System 85, the Recall feature must be administered on a standard feature button.

On 8434 and 8434DX voice terminals connected to a DEFINITY G3V3 or later, the system manager can choose to administer alternate features for use with the softkeys. The following table lists some of the alternate softkey features, those features that can be substituted for the default softkey features listed above and on the previous page.

**NOTE:**

The DEFINITY ECS Release 5 (and later releases) may provide additional alternate softkey features.

<b>12</b>	The 8400 Series Voice Terminals <i>The 8434 and 8434DX Voice Terminals</i>	12-80
-----------	---	-------

**⇒ NOTE:**

With G3V3 and later switches, the system can download *BLANK* softkey labels for positions where there are no features administered.



**Table 12-25. Alternate Softkey Features on the 8434 and 8434DX Connected to a DEFINITY G3V3 and Later**

Abbreviation	Feature and Description
<b>AD</b>	Abbreviated Dialing buttons (can be multiple AD buttons)
<b>Count</b>	ACD Stroke Count
<b>CPkup</b>	Call Pickup
<b>Dir<sup>*</sup></b>	Directory
<b>HFAns<sup>†</sup></b>	Internal Auto Answer
<b>IAuto</b>	Intercom Auto
<b>IDial</b>	Intercom Dial
<b>Inspt</b>	Inspect
<b>Last</b>	Last Number Dialed
<b>RngOf</b>	Ringer Off
<b>SAC</b>	Send All Calls
<b>SFunc</b>	Abbreviated Dialed Special Function
<b>Stats</b>	View (ACD) Statistics
<b>Stop</b>	Abbreviation Dialing Indefinite Wait or Stop
<b>View<sup>‡</sup></b>	Stored Number

\* A CALL DISPLAY button should be administered, if access to System Directory is provided. It is also desirable for a NEXT DISPLAY button to be administered. This feature is *not* available on a DEFINITY G2 or System 85.

† This feature is available only on a DEFINITY G3V2 (and later) switches.

‡ This feature is *not* available on a DEFINITY G2 or System 85.

## Other Physical Features

### Handset

The 8434 and 8434DX voice terminals are equipped with a K-type handset.

### Dial pad

The 8434 and 8434DX voice terminals are equipped with a 12-button touch-tone dial pad. The letters "Q" and "Z" have been added to the appropriate dial pad keys for directory access, and the "5" button on your dial pad has raised bars for visually-impaired users.

### Jacks

The 8434 and 8434DX voice terminals' housing contains a Line jack and Speakerphone/headset adapter jack on the back of the voice terminal and a Handset cord jack on the side of the housing. The 8434DX has an Expansion Module ("EX MOD") jack on the back of the voice terminal to allow connection of an 801A expansion module.

### Cords

Two cords are supplied with the 8434 and 8434DX voice terminals: a coiled 9-foot modular handset cord and a 7-foot modular line cord.

Optional longer cords are available: a 12-foot handset cord, 14-foot and 25-foot line cords.

### Ringling

The 8434 and 8434DX voice terminals have electronic tone ringling with eight possible ringling patterns that can be selected with the RING button on some 8434 and 8434DX voice terminals; on other voice terminals, the user presses the SHIFT button and the HOLD button in order to choose a ringling pattern.

The loudness of the tone ringer can be controlled by the VOLUME "arrow" button. (The user must NOT be on a speakerphone call. If the user is using the speakerphone, the VOLUME "arrow" button controls the volume of the speakerphone.)

### Mounting Options

The 8434 and 8434DX voice terminals come equipped with a nonadjustable desk stand. These voice terminals *cannot* be wall-mounted.

### Color Options

The 8434 and 8434DX voice terminals are available in black and in white.

## Wiring Information

The 8434 and 8434DX voice terminals work in both 4-wire and 2-wire DCP configurations. The table below describes the pins on an 8400-Series voice terminal LINE jack.

**Table 12-26. The Pins on an 8400-Series Voice Terminal LINE Jack**

Line Interface			
Pin	Pair	Name	Description
1	2	OD1	4-Wire Output
2	2	OD2	4-Wire Output
3	3	ID1	4-Wire Input
4	1	U-T	2-Wire (Tip)
5	1	U-R	2-Wire (Ring)
6	3	ID2	4-Wire Input
7	4	P1-	Adjunct Power -48V
8	4	P2+	Adjunct Power Common

### ⇒ NOTE:

Regardless of which configuration is in use, ALL wiring between the PBX and the terminal MUST consist of twisted-pairs, including the modular line cord. The line cord must be a D8W, which consists of four twisted-pairs, or a Lucent Technologies-approved equivalent.

Twisted-pair wiring is used to make lines less sensitive to crosstalk. Therefore, failure to use twisted pair wiring may result in less-than-optimum performance of the terminal and may also contribute to problems with the line.

An 8-wire modular cord MUST be used for all 4-wire and any 2-wire installations requiring auxiliary power.

### ⇒ NOTE:

You do NOT need to change any settings on the voice terminal for 2-wire or 4-wire installations. The voice terminal is able to detect whether it is in a 2-wire or a 4-wire configuration.

For 2-wire operation, if you need to plug the voice terminal into a 4-pin or 6-pin wall jack, instead of a standard 8-pin modular jack, refer to the "Line Interface" table to insure that the wires from the 4-pin or 6-pin wall jack are connected to the correct pins on the terminal "LINE" jack.

In order for the terminal to function properly in either 2-wire or 4-wire installations, there must be NO INTERCONNECTIONS between the wire pairs used for 2-wire and 4-wire operations. Bridging or paralleling of these pairs can result in damage to the terminal or can cause the PBX circuit pack to remove power to the terminal.

REMOVE ALL CONNECTIONS BETWEEN PAIRS BEFORE CONNECTING THE TERMINAL.

4-WIRE installations MUST ONLY have PBX connections on pair 2 and pair 3 and, if necessary, auxiliary power must be connected to pair 4.

2-WIRE installations MUST ONLY have PBX connections on pair 1 and, if necessary, auxiliary power must be connected to pair 4.

## Distance Limitations

---

The following circuit packs can be used with all of the 8400-Series sets.

**Table 12-27. Circuit Packs Used with the 8400-Series Voice Terminals**

Circuit Pack	2/4-Wire	Will support these switches
TN2181 - 16-port	2-wire	G3V3, G3V2
TN754b - 8-port	4-wire	All switches except System 85
TN754 - 8-port	4-wire	All switches except System 85
TN413 - 8-port	4-wire	International System 75
SN 270 and SN 270B - 4-port	4-wire	System 85 R2V2 - R2V4

**In 4-wire operation**, the voice terminal must be within 5,000 feet of the PBX using 22-gauge or 24-gauge wire, and within 4,000 feet of the PBX using 26-gauge wire.

**In 2-wire operation**, the voice terminal must be within 5,500 feet of the PBX using 22-gauge wire, within 3,500 feet of the PBX using 24-gauge wire, and within 2,200 feet of the PBX using 26-gauge wire.

## Power Requirements

---

The 8434 and 8434DX voice terminals are phantom-powered from the system cabinet on the digital pairs of the line wiring.

In order to use the display on the 8434 or 8434DX voice terminal or, with the 8434DX, connect and use an 801A expansion module, you must connect an auxiliary power source to the voice terminal. Recommended local power supplies

**12** The 8400 Series Voice Terminals  
*The 8434 and 8434DX Voice Terminals*

12-85

are the 1151A1 power supply and the 1151A2 power supply with Battery Holdover. The 1145A and 1145B1 are recommended bulk power supplies. See the section titled **Adjunct Power** earlier in this manual for more information about these power supplies.

## Switch Administration

---

### Aliasing

Use the following table to administer the 8434 and 8434DX voice terminals:

**NOTE:**

The voice terminal can be administered so it can access the softkey features OR it can be administered so that it has access to more coverage buttons.

**Table 12-28. Administering the 8434 and 8434DX Voice Terminals**

If you have this System	and this Release	(which can support this type of operation)	Administer the 8434 or 8434DX as a
System 75	R1V1 — R1V3	4-wire only	7405D+D+F
System 85	R2V2—R2V4	4-wire only	7405D+D+F
International System 75	IR1V4, etc.	4-wire only	7405D+D+F
DEFINITY G1		4-wire only	7405D+D+F
Global DEFINITY '91		4-wire only	7405D+D+F or 7434+D
DEFINITY G2V1		4-wire only	7405D+D+F or 7434+D
DEFINITY G2V2		4-wire only	7405D+D+F or 7434+D
DEFINITY G3i, G3r, G3s, G3vs		4-wire only	7405D+D+F or 7434+D
DEFINITY G3V2		2- or 4-wire	7405D+D+F or 7444
DEFINITY G3V3 and later		2- or 4-wire	8434D

**Key to Abbreviations:**

+D = with Display Module

+F = with Feature Key Module

## CAVEATS

The 8434 and 8434DX may be aliased as a 7405+D+F to support features on all systems. However, in this case, while all the call appearance/feature buttons AND the softkey features will be functional, there can be a maximum of only 10 call appearances. On the 7405, the Display Module is a 1-line display, and thus the 1-line display option should be selected.

On some systems, the 8434 and 8434DX can be aliased as a 7434+D or a 7444 to support coverage. In this case, there can be up to 34 call appearances (including bridged call appearances), but the 15 softkey features will NOT be functional because the Feature Key Module is not allowed with the 7434 or 7444. On the 7434, the Display Module is a 1-line display, and thus the 1-line display option should be selected. If the set is administered as a 7444, it can be optioned for a 2-line display.

For switch administration procedures for an 8434DX voice terminal with an expansion module connected to it, see the 801A Expansion Module information in the section titled **Adjuncts**.

## Button Numbering

The following button diagrams of the 8434 and 8434DX voice terminal will help you administer it with a System 75, a DEFINITY G1 or G3, or a DEFINITY ECS, and with a System 85 or a DEFINITY G2.

Figure 12-23 refers to the 8434 and 8434DX voice terminal connected to a System 75, a DEFINITY G1 or G3, or a DEFINITY ECS; Figure 12-24 refers to the 8434 and 8434DX voice terminal connected to a System 85 or a DEFINITY G2.

If you need more information, refer to *DEFINITY Communications System Generic 1 Implementation*, 555-230-653, and *DEFINITY Communications System Generic 2 Administration of Features and Hardware*, 555-104-507.

If administered as a 7405D, administer the 15 softkey features as "FEATURE MODULE BUTTON ASSIGNMENTS" 2 through 16. Administer the Normal feature on Button #1 on the "DISPLAY BUTTON ASSIGNMENTS" screen.

If administered as itself, administer the 15 softkey features on "SOFTKEY BUTTON ASSIGNMENTS" 1 through 15.

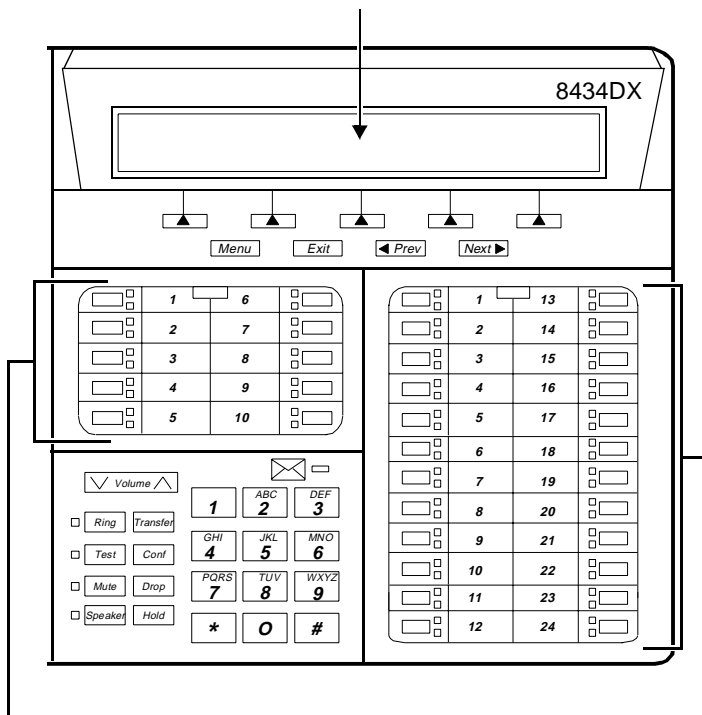

The 10 call appearance/feature buttons in the left 2 columns are administered as "BUTTON ASSIGNMENTS" 1 through 10.

The 24 call appearance/feature buttons in the right 2 columns are administered as "FEATURE BUTTON ASSIGNMENTS" 1 through 24.

(On the 7434 or 7444, these buttons are labeled "BUTTON ASSIGNMENTS" and numbered 11 through 34.)

Figure 12-23. Button Numbering for Administering the 8434 and 8434DX Voice Terminal Connected to a System 75, a DEFINITY G1 or G3, or a DEFINITY ECS

If administered as a 7405D, administer the 15 softkey features as "FEATURE MODULE BUTTON ASSIGNMENTS" 2 through 16. Administer the Normal feature on Button #1 on the "DISPLAY BUTTON ASSIGNMENTS" screen.

If administered as itself, administer the 15 softkey features on "SOFTKEY BUTTON ASSIGNMENTS" 1 through 15.

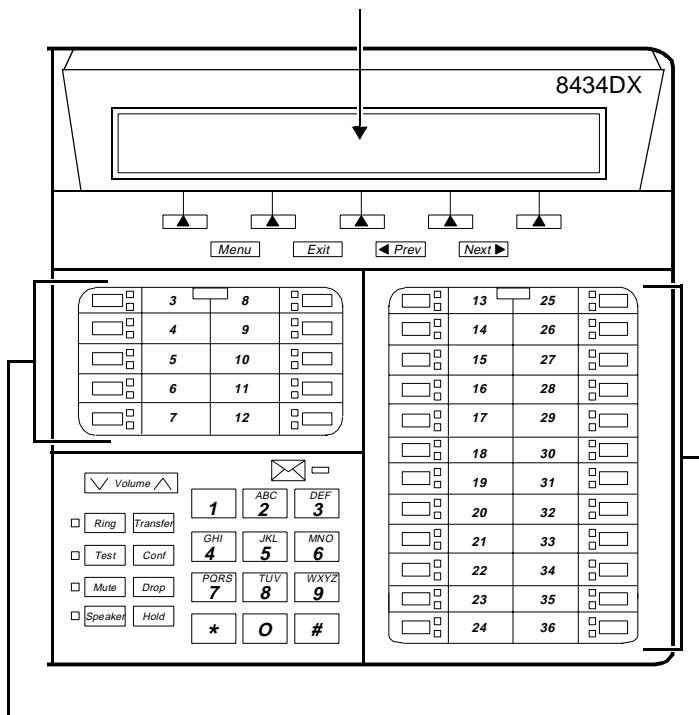

The 10 call appearance/feature buttons in the left 2 columns are administered as "BUTTON ASSIGNMENTS" 3 through 12.

The 24 call appearance/feature buttons in the right 2 columns are administered as "FEATURE BUTTON ASSIGNMENTS" 13 through 36.

(On the 7434 or 7444, these buttons are labeled "BUTTON ASSIGNMENTS" and numbered 11 through 34.)

Figure 12-24. Button Numbering for Administering the 8434 and 8434DX Voice Terminal Connected to a System 85 or a DEFINITY G2

## Power Failure Operation

The 8434 and 8434DX voice terminals cannot be used as an emergency station during power failure transfer conditions.



**12** The 8400 Series Voice Terminals  
*The 8434 and 8434DX Voice Terminals*

12-89

## FCC Registration

These voice terminals are FCC-registered along with the switch (as a system), but do not have a separate FCC registration label.

## UL and CSA Approval

These voice terminals have been tested and have met the Underwriters Laboratories (UL) Standards UL 1459 and have also met the Canadian Standards Association (CSA) Standards CSA-C22.2 No.225-M90.

## Hearing Aid Compatible

These voice terminals are compatible with the inductively coupled hearing aids prescribed by the FCC.

## 8434 and 8434DX Equipment PECs and Comcodes

The 8434 and 8434DX voice terminals and optional components can be ordered with the following PECs and Comcodes:

- **Basic 8434 (8434D04A) Voice Terminal**  
Black 8434 Set PEC: 3236-06B  
Comcode: 106790439;  
White 8434 Set PEC: 3236-06W  
Comcode: 106790447
- **Enhanced 8434DX (8434D04A) Voice Terminal**  
Black 8434DX Set PEC: 3236-06B  
Comcode: 107707986;  
White 8434DX Set PEC: 3236-06W  
Comcode: 107707994
- **K2S8 Handset**  
Comcode: Black=107545584; White=107545568
- **Handset cord (9 feet)**  
Comcode: Black=407632819; White=407632835
- **Line Cord (7 feet)**  
Comcode: 103786778
- **Line cord (14 feet, silver)**  
PEC: 2725-07N COL18  
Comcode: 103786802
- **Line cord (25 feet, silver)**  
PEC: 2725-07S COL18  
Comcode: 103786828

12 The 8400 Series Voice Terminals  
The 8434 and 8434DX Voice Terminals

12-90

- **Small Designation Card Cover (for 10 buttons on left of terminal)**  
PEC: 32309  
Comcode: 846320216
- **Large Designation Card Cover (for 24 buttons on right of terminal)**  
PEC: 32314  
Comcode: 847037553
- **Small Button designation card (for 10 buttons on left of terminal)**  
Tractor Feed For 25 Sets, 3 Sheets (12 cards per sheet)  
PEC: 32310  
Comcode: 847161817;  
Tractor Feed For 100 Sets, 9 Sheets (12 cards per sheet)  
PEC: 32311  
Comcode: 847161916
- **Large Button designation card (for 24 buttons on right of terminal)**  
Tractor Feed For 25 Sets, 13 Sheets (2 cards per sheet)  
PEC: 32315  
Comcode: 847141504;  
Tractor Feed For 100 Sets, 50 Sheets (2 cards per sheet)  
PEC: 32316  
Comcode: 847168747

## Adjuncts

---

The following adjuncts can be used with the 8434 and 8434DX voice terminals:

### NOTE:

Auxiliary power is required when any adjuncts are added to the voice terminal, except for the 7400B Plus Data Module which is AC powered. For auxiliary power, an 1151A1 local power supply or an 1151A2 power supply with Battery Holdover is recommended.

- An 801A Expansion Module can be connected to an 8434DX voice terminal connected to a DEFINITY G3V3.3 (or later).
- S101A Speakerphone (no longer orderable)
- S201A Speakerphone
- CS201A Speakerphone
- 7400B Plus Data Module in a 4-wire environment;  
8400B Plus Data Module in a 2-wire environment
- 500A Headset Adapter (and a standard headset; see “Headsets” on the next page)
- K6S2 Amplifier Handset
- Shoulder Rest

## Headsets

A list of compatible headsets, consisting of both modular and plug prong base units and selection of headpieces, appears in "Headset Adapters" in the **Adjuncts** section later in this manual.

## Additional Documents

---

The following documents contain additional information relating to the 8434DX voice terminal: (Use the 9-digit number listed after each document to order that book from the BCS Publications Center for Lucent Technologies.)

- *8400-Series Voice Terminals Instructions for Installation, Switch Administration, and Programming the Options*, 555-015-165
- *DEFINITY Communications System Generic 1 and 3 and System 75 8434 Voice Terminal User's Guide*, 555-230-765
- *DEFINITY Communications System Generic 1 and 3 and System 75 8434 Voice Terminal Quick Reference Guide*, 555-230-766
- *DEFINITY Communications System Generic 2 and System 85 8434 Voice Terminal User's Guide*, 555-104-765
- *DEFINITY Communications System Generic 2 and System 85 8434 Voice Terminal Quick Reference Guide*, 555-104-766
- *DEFINITY Communications System Generic 1 and 3 and System 75 8434DX Voice Terminal User's Guide*, 555-230-856
- *DEFINITY Communications System Generic 1 and 3 and System 75 8434DX Voice Terminal Quick Reference Guide*, 555-230-857
- *DEFINITY Communications System Generic 2 and System 85 8434DX Voice Terminal User's Guide*, 555-104-767
- *DEFINITY Communications System Generic 2 and System 85 8434DX Voice Terminal Quick Reference Guide*, 555-104-768
- *801A Expansion Module Instruction Manual*, 555-015-136

<b>12</b>	The 8400 Series Voice Terminals <i>The 8434 and 8434DX Voice Terminals</i>
-----------	---

12-92

## CALLMASTER Voice Terminals

# 13

---

This section describes the following CALLMASTER voice terminals:

- CALLMASTER voice terminal
- CALLMASTER II voice terminal
- CALLMASTER III voice terminal
- CALLMASTER IV voice terminal
- CALLMASTER V voice terminal
- CALLMASTER VI voice terminal

# The CALLMASTER, CALLMASTER II, CALLMASTER III, CALLMASTER IV, CALLMASTER V, and CALLMASTER VI Voice Terminals

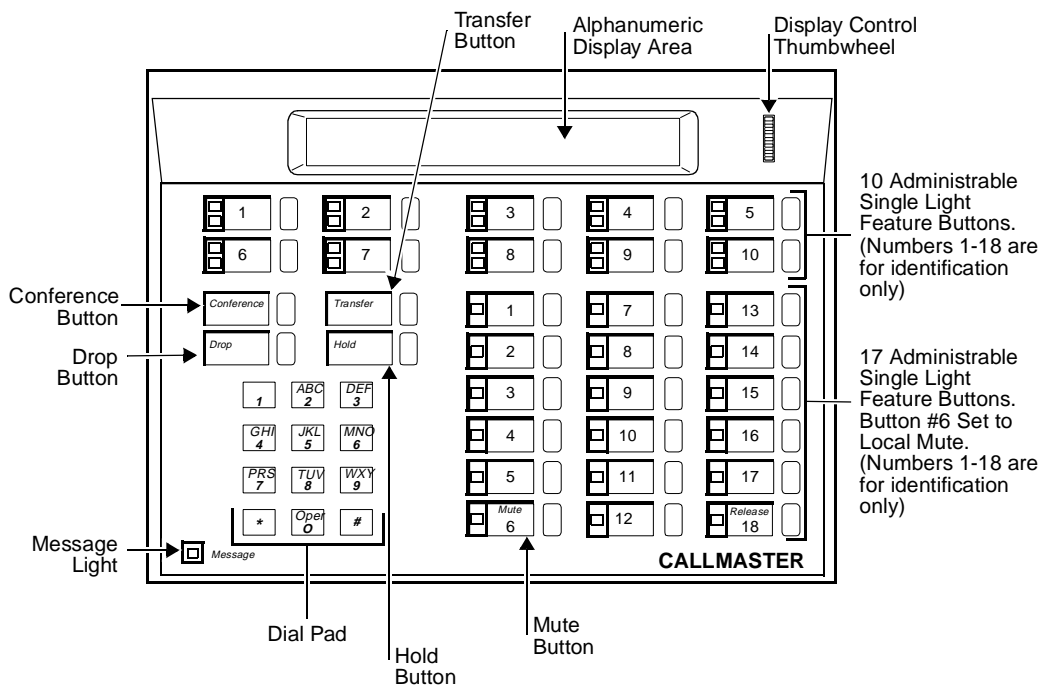

Figure 13-1. The 602 CALLMASTER Voice Terminal

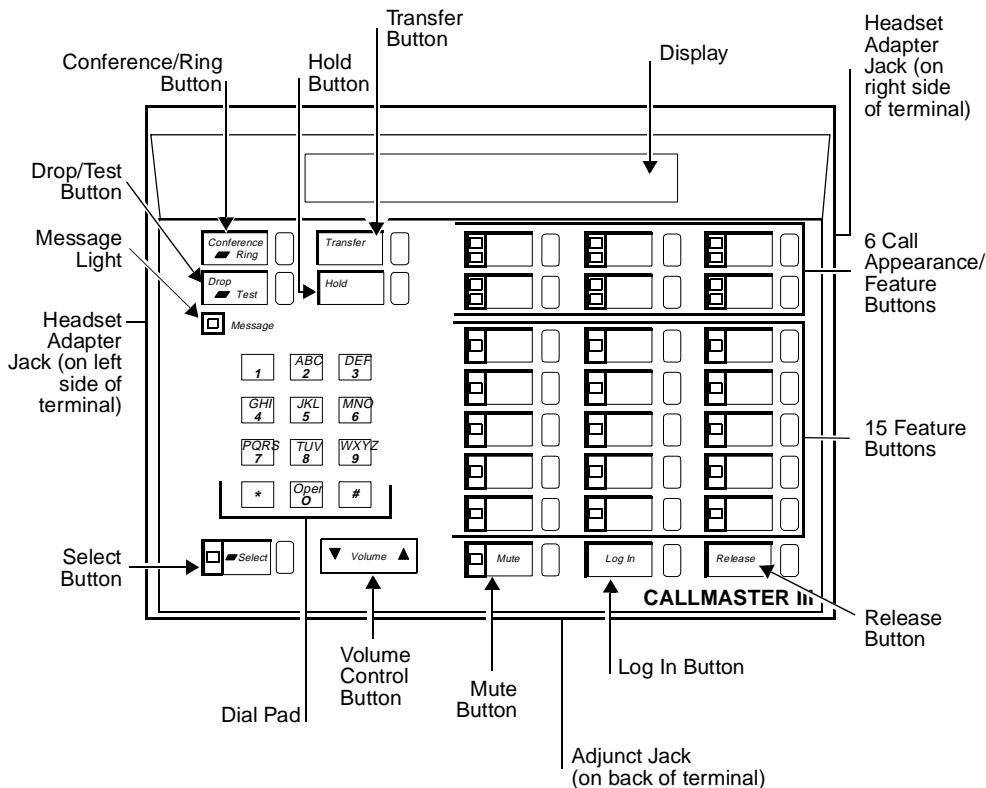

Figure 13-2. The CALLMASTER II and CALLMASTER III Voice Terminal

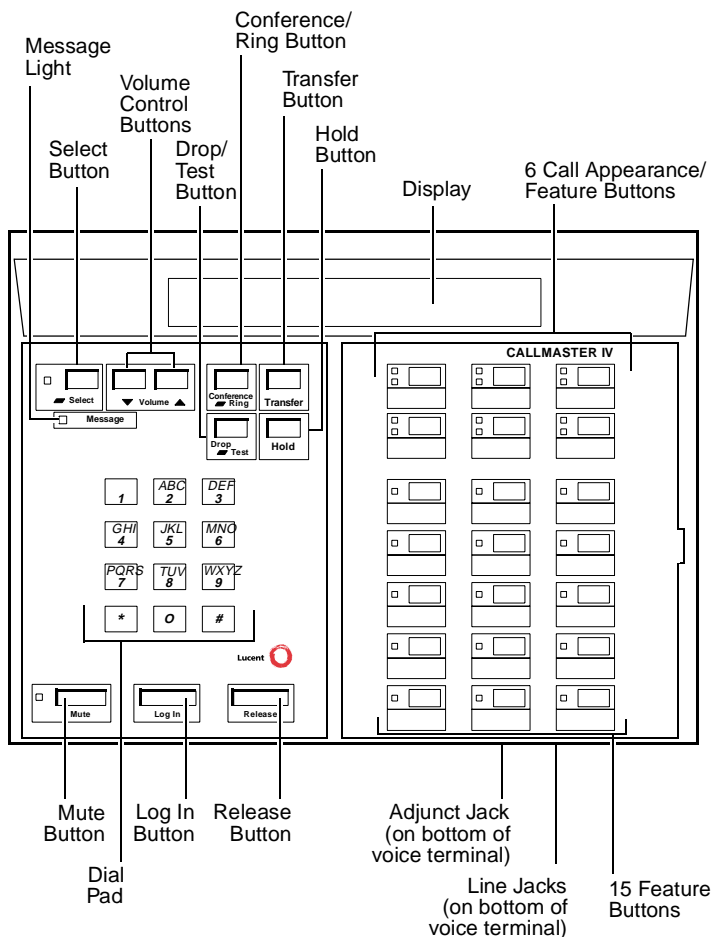

Figure 13-3. The CALLMASTER IV Voice Terminal



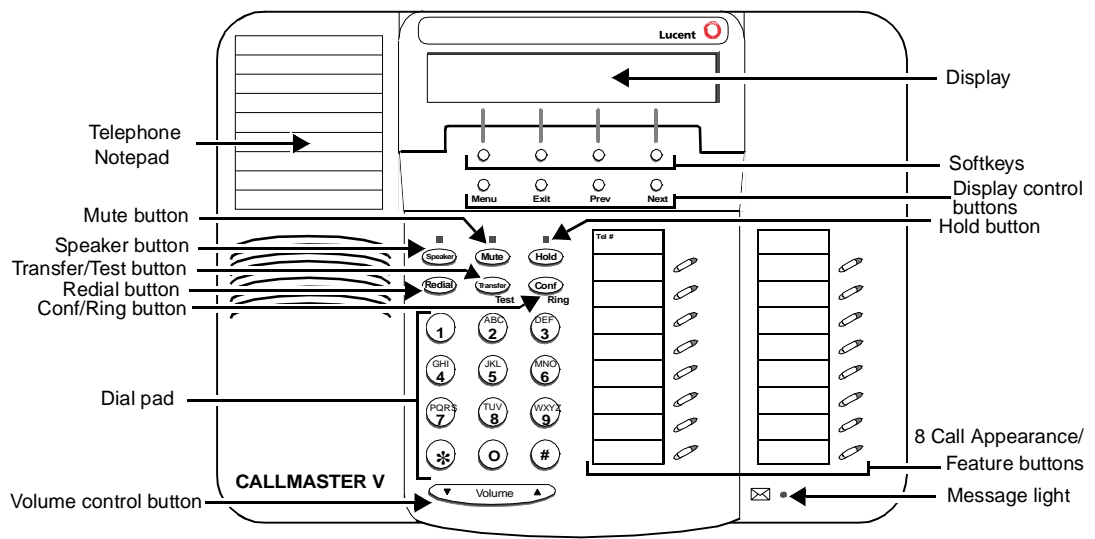

Figure 13-4. The CALLMASTER V Voice Terminal

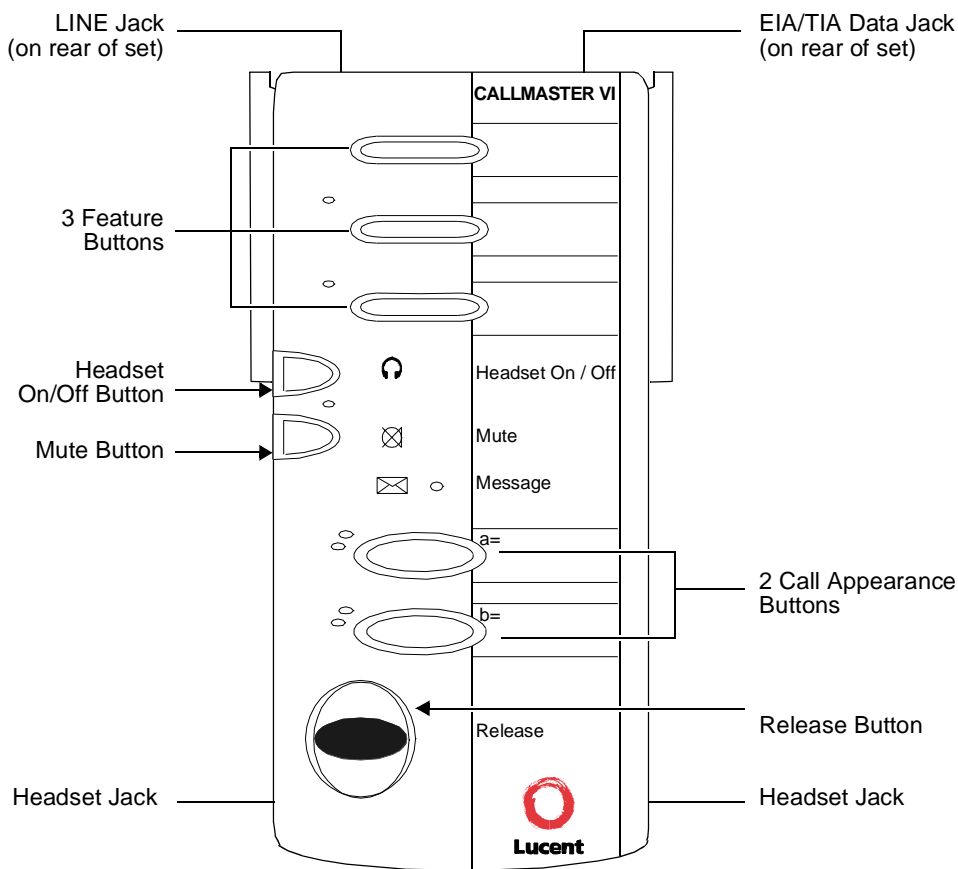

Figure 13-5. The CALLMASTER VI Voice Terminal



The CALLMASTER is a multi-appearance digital voice terminals used primarily as a Call Management or Automatic Call Distribution (ACD) position. All CALLMASTER models except the CALLMASTER VI, which will be described further on in this chapter, are equipped with a 2-line by 40-character display that can be used to provide information on incoming and outgoing calls. The unit can be programmed to enter an After-Call Work State following each call for the completion of service paperwork and can be configured for zip tone operation where calls follow one another in a rapid sequence.

There are several types of CALLMASTER voice terminals:

- The 602 CALLMASTER comes in two models: the 602A and the 602D. Although both of these models are the same in appearance, the 602D CALLMASTER has a Recorder Interface which allows you to connect the voice terminal to a recording device so that you can record all voice interactions. The 602A does *not* have a recording interface.
- The 603D CALLMASTER, called the CALLMASTER II, comes with Recorder Interface to record voice interactions.
- The 603E CALLMASTER, called the CALLMASTER III, comes without Recorder Interface.

 **NOTE:**

The CALLMASTER II and the CALLMASTER III are identical in appearance; For easy identification, the model number is printed on a sticker on the bottom of the voice terminal.

- The 603F1 CALLMASTER, called the CALLMASTER IV, comes in only one model; it is equipped with a Recorder Interface.
- The 607A1 CALLMASTER, called the CALLMASTER V, comes in two models, an English standard-labeled button set (that is, with buttons labeled with **Hold**, **Transfer**, and so forth) and an icon-labeled set (that is, with buttons labeled with icons such as , rather than **Hold**, and  instead of **Transfer**. Both the English-labeled and the icon sets have a Recorder Interface.
- The 606A1 CALLMASTER, called the CALLMASTER VI, is much different than the other CALLMASTERS since it works with an application software package, usually Lucent CentreVu<sup>®</sup> Agent, through a connection with a PC.

The 602 CALLMASTER has four fixed features (CONFERENCE, DROP, HOLD, and TRANSFER), 10 call appearance/feature buttons, each with a red and green light, 17 feature-only buttons, each with a green status light, a Message light, a MUTE button, and a 2-line by 40-character display. The front panel of the 602 CALLMASTER drops down to reveal a SELF-TEST button, a Ringer-volume control, and a 1-2 switch which can be set only by an installer.

The CALLMASTER II and III models have four fixed features (CONFERENCE, DROP, HOLD, and TRANSFER), six call appearance/feature buttons, each with a red and green light, 15 feature-only buttons, each with a green status light, a Message light, a MUTE button, a SELECT button, a LOG IN and RELEASE button used for processing ACD calls, and a 2-line by 40-character supertwist liquid crystal display.

The CALLMASTER IV has a 2-line by 40-character liquid crystal display, four fixed features (CONFERENCE/RING, DROP/TEST, HOLD, and TRANSFER), a SELECT button, two Volume control buttons (one for raising the volume and one for lowering the volume), and a Message light, all at the top of the voice terminal.

The CALLMASTER IV set also has six call appearance/feature buttons, each with a red and green light, and 15 feature-only buttons, each with a green status light. At the bottom of the CALLMASTER IV is a MUTE button, a LOG IN and RELEASE button used for processing ACD calls.

The CALLMASTER V is very similar to the 6416D+ telephone, since it can only be used in a 2-wire environment, has 16 call appearance/feature buttons, and has a display with softkeys and display control buttons with which the user can access other features besides those administered on feature buttons. These telephones also have six standard fixed feature buttons: a SPEAKER button, which can access a one-way, listen-only speakerphone, MUTE button to mute the handset, a red HOLD button, REDIAL button, TRANSFER/TEST button for transferring a call or testing the lights and display on the telephone, and a CONF/RING button for setting up a conference call and for selecting a personalized ringing pattern. These telephones also have a red Message light and a Volume control button.

The CALLMASTER VI is a miniature voice terminal which has two call appearance buttons with a red and green light beside each button, three feature buttons, two of which have an associated green light, a MUTE button and a HEADSET ON/OFF button which share a red light, and a blue RELEASE button. Other features can also be used according to the software application on the PC.

On each of the two sides of the 602 CALLMASTER, the CALLMASTER II, CALLMASTER III, CALLMASTER IV, and CALLMASTER VI, there is a headset jack in which you can plug in a headset or, if special adapters are used, a handset. (The CALLMASTER V also has a headset jack; however, it is located on the bottom of the set.)

On the rear of the 602 CALLMASTER, there is a jack for an optional kneewall adapter. You can plug two headsets or two handsets into this adapter. (Both headsets or handsets must be the same model.)

## Applications

The 602 CALLMASTER can be used with the DEFINITY Communications System Generic 1, Generic 2, and Generic 3, the DEFINITY ECS, System 75 (R1V3 or later), and System 85 (R2V2 or later).

The 603 voice terminals, which include the CALLMASTER II, CALLMASTER III, and CALLMASTER IV, can be used only with a DEFINITY ECS G3V3 and later.

The CALLMASTER V and CALLMASTER VI work only with a DEFINITY ECS Release 6.1. These voice terminals are especially suitable for Call Management or ACD call-handling positions.

## Special Operational Characteristics

---

The CALLMASTER voice terminals do not have a physical switchhook or handset cradle (although a handset cradle kit can be ordered separately). These sets are on-hook when there is no headset plugged physically into either of the two headset jacks. The voice terminals are off-hook when one or more headsets are plugged into one of the headset jacks.

## The Recorder Interface

The 602D CALLMASTER, the CALLMASTER II, the CALLMASTER IV, and the CALLMASTER V voice terminals provide a recorder interface which is designed for recording calls on a standard analog tape recorder. (A recorder with AGC [Automatic Gain Control] is recommended on the CALLMASTER II with Recorder Interface.) With this interface, a warning tone (a soft beep repeated every 15 seconds) notifies the agent and the calling party that the call is being recorded. *Be aware that this tone may be a legal requirement.*

### NOTE:

The default setting for the Recorder Interface and the Recording Warning Tones on the CALLMASTER II with Recorder Interface is "Enabled"; on the CALLMASTER IV and CALLMASTER V, the default for both of these features is "Disabled." However, the interface and the warning tones can always be changed to the enabled or disabled state. For directions on enabling and disabling these two features on the CALLMASTER II, III, and IV, see the *DEFINITY ECS CALLMASTER II, CALLMASTER III, and CALLMASTER IV Voice Terminals Instructions for Programming the Options*, 555-015-172.

The application software installed on the PC to which the CALLMASTER VI is connected has an Announcements Recorder feature which enables recording and playback of personalized announcements. The user can record up to six announcements at a length of 9.6 seconds per announcement. The application software provides the user interface to record and play back the announcements, while the CALLMASTER VI provides the sound chip for which announcements are recorded and stored.

## Physical Description

---

### Dimensions

The following dimensions for the 602 CALLMASTER, CALLMASTER II, CALLMASTER III, and CALLMASTER IV are approximate.

Width = 11 inches

Depth (front to back) = 8-1/2 inches

Height = 5-1/2 inches

The following are the approximate dimensions for the CALLMASTER V:

Width = 10.35 inches (26.35 cm)

Depth (front to back) = 8.5 inches (21.59 cm)

Height (with deskstand and handset in place) = 4.75 inches (12.07 cm)

The dimensions directly below for the CALLMASTER VI are also approximate.

Width = 3-1/4 inches

Depth (front to back) = 7-1/4 inches

Height = 2 inches (at the top of the terminal);

1-1/8 inches (at the bottom of the terminal)

## Features

### Four Fixed Feature Buttons

The 602 CALLMASTER, CALLMASTER II, CALLMASTER III, CALLMASTER IV, and CALLMASTER V have the following fixed feature buttons:

- CONFERENCE or CONFERENCE/RING button
- DROP or DROP/TEST button
- TRANSFER button
- HOLD button

### Message Light

The Message light goes on when a message is left for the user. It goes off when the user retrieves the message. On the 602 CALLMASTER, the Message light is green; on the CALLMASTER II, CALLMASTER III, CALLMASTER IV, CALLMASTER V, and the CALLMASTER VI, the Message light is red.

### Call Appearance/Feature Buttons

The 602 CALLMASTER voice terminal has 10 call appearance/feature buttons; the CALLMASTER II, CALLMASTER III, and CALLMASTER IV have six call appearance/feature buttons; the CALLMASTER V has 16 call appearance/feature buttons. The CALLMASTER VI has two call appearance buttons. Each of these buttons has a red appearance light and a green status light stacked to the left of the button. On all of these CALLMASTER models except the CALLMASTER VI, these buttons can be used as call appearances or for features that are assigned during administration. On the CALLMASTER VI, the two call appearance buttons are used only as call appearances.

### Feature-Only Buttons

The 602 CALLMASTER voice terminal has 17 feature buttons; the CALLMASTER II, CALLMASTER III, and CALLMASTER IV have 15 feature buttons. The CALLMASTER VI has three feature buttons. Each button, except for

the top feature button on the CALLMASTER VI, has a green status light associated with it. These buttons can be used for features assigned during administration.

 **NOTE:**

The CALLMASTER V does not have any Feature-Only buttons.

### Listen-Only SPEAKER

Only the CALLMASTER V has a one-way, listen-only speaker. If the user wishes to speak to the caller, he/she must use the headset (or, if applicable, the handset).

### MUTE Button

All CALLMASTER sets have a MUTE button, a fixed feature button. The Mute feature allows the user to be in a listen-only mode. On the 602 CALLMASTER, the MUTE button light is green; on the CALLMASTER II, CALLMASTER III, CALLMASTER IV, CALLMASTER V, and the CALLMASTER VI, the light next to the MUTE button is red.

 **NOTE:**

The default setting for the Mute feature on all the CALLMASTER sets is "Enabled." For directions on enabling and disabling the Mute feature on the CALLMASTER II, III, and IV, see the *DEFINITY ECS CALLMASTER II, CALLMASTER III, and CALLMASTER IV Voice Terminals Instructions for Programming the Options*, 555-015-172.

### SELECT button

The CALLMASTER II and III and the CALLMASTER IV voice terminals have a SELECT button that can be used in two different ways: (The green light next to the SELECT button goes on steadily when the SELECT button is activated.)

- Used with the CONFERENCE/RING button to select one of eight personalized ringing patterns for incoming calls
- Used with the DROP/TEST button to initiate the Self-Test feature which tests the lights, ringer, and display

### VOLUME control button

The 602 CALLMASTER has a volume control slide switch behind the front panel. This slide switch controls the volume of the tone ringer.

The CALLMASTER II, III, and V terminals have a VOLUME "arrow" button with a double function. When the user is on a call, the VOLUME button controls the volume of incoming transmission on the headset or handset whichever is being used; when the user is not on a call, the VOLUME control button adjusts the tone ringer. On the CALLMASTER IV voice terminal there are two separate volume control buttons, one to lower the volume and one to raise the volume.

When the user sets the volume for the headset or handset or for the tone ringer on the CALLMASTER II and III, IV, or on the CALLMASTER V, the display on the voice terminal shows a “bar array” that indicates the volume setting.

## LOG IN and RELEASE buttons

On the CALLMASTER II, CALLMASTER III, and CALLMASTER IV, the LOG IN and RELEASE buttons are located in the bottom row of feature buttons. These buttons *must* be used for these two ACD features: the Log in feature and the Release feature. *No other feature should be administered on these buttons.*

The CALLMASTER VI has three feature buttons at the top of the set on which there may be programmed such ACD features as Log In/Off, Auto In, or Assist. This voice terminal also has a dedicated blue RELEASE button.



### NOTE:

The CALLMASTER V does not have a dedicated RELEASE or HANDSET ON/OFF button. These features must be administered on blank buttons on the set.

## Self-Test

On the 602 CALLMASTER, the user presses and holds down a SELF-TEST button behind the front panel of the set to perform a self-test of the lights, display, and the ringer.

On the CALLMASTER II, CALLMASTER III, and CALLMASTER IV, the user presses the SELECT button and then presses and holds down the DROP/TEST button to initiate a test of the lights, ringer, and display on the voice terminal. The CALLMASTER V has a TRANSFER/TEST button.

## Display

All CALLMASTER voice terminals, except the CALLMASTER VI, have a 2-line by 40-character per-line display located at the top of the voice terminal. (The CALLMASTER VI is connected to a PC, and the agent using this voice terminal views the telephone and ACD feature information on the PC screen.) By using the voice terminal display, the user can retrieve personal messages or display queue status without losing call identification. The terminal displays call appearance-related information on the first line. All non-call appearance-related and local information is displayed on the second line of the display.

The 602 CALLMASTER has a display contrast thumbwheel which can be rotated to make the display contrast darker or lighter.



### NOTE:

The CALLMASTER II, CALLMASTER III, and CALLMASTER IV can be optioned for a 1-line or a 2-line display. The 2-line (by 40 characters) format is the expected normal usage. The 1 line format is needed only when the



CALLMASTER is administered as a 7405D with a D401 display, as a 7406D, or as any other set with a 1-line display format. The default is the 2-line display. To change this setting, see the *DEFINITY ECS CALLMASTER II, CALLMASTER III, and CALLMASTER IV Voice Terminals Instructions for Programming the Options*, 555-015-172.

## Other Physical Features

### Headsets

The CALLMASTER voice terminals are designed to use carbon miked headsets. A maximum of two headsets can be connected at the same time. The quality of transmission may be affected if different types of headsets are used together.

### Handset

An optional K-type handset kit is available for the CALLMASTER voice terminals. This kit contains a handset cradle, a handset, and the required adapter. The handset plugs into the headset jack and functions as though a headset was being used. This handset does not provide switchhook capabilities.

### Dial pad

All CALLMASTER models, except the CALLMASTER VI, are equipped with a 12-button touch-tone dial pad. On the CALLMASTER VI, the user can use the dial pad on the screen of the PC connected to the voice terminal.

### Jacks

The 602 CALLMASTER, CALLMASTER II, CALLMASTER III, CALLMASTER IV, and CALLMASTER VI voice terminals' housing contains three jacks. The line cord jack is located on the rear of the unit. Two PJ327 type (2-prong) jacks allow the headset or optional handset to be plugged into either side of the unit. The CALLMASTER V has a line cord jack, a headset jack, and a handset jack (which can be used for a headset), all on the bottom of the set.

### NOTE:

Since the CALLMASTER IV can be used in a 2-wire OR 4-wire setting, this voice terminal has two Line jacks, one for 2-wire operation and one for 4-wire operation.

The CALLMASTER II, CALLMASTER III, and CALLMASTER IV also have another jack, an Adjunct jack, located on the back of the voice terminal for connecting adjunct equipment to the voice terminal.

The CALLMASTER VI also has another jack, not located on the other CALLMASTER sets, an EIA Data jack located on the rear of the voice terminal. An EIA/TIA-574 cable connected to this Data jack on the CALLMASTER VI and, at the other end, to a Serial COM port on a PC provides full access to the application software, such as CentreVu Agent, loaded on the PC.

## **Cords**

A D8W-87 line cord and a Handset cord are provided with all CALLMASTER voice terminals. An EIA/TIA Data cord is also shipped in the box with the CALLMASTER VI set.

## **Kneewell Adapter (602 CALLMASTER only)**

An optional adapter is available for connecting two headsets or handsets to the 602 CALLMASTER. This adapter allows the handset or headset to be connected without the cords running across the top of the desk.

## **Ringling**

The CALLMASTER voice terminals have electronic tone ringling with patterns that are set at administration.

## **Mounting Options**

All the CALLMASTER voice terminals, except the CALLMASTER VI, are only available as a desk model; they cannot be wall mounted. The CALLMASTER VI can be used on a flat surface such as a desk, or it can be mounted with velcro strips on a wall or on the side of the PC.

## **Color Options**

The 602 CALLMASTER is available in black and misty cream. The CALLMASTER II, CALLMASTER III, and CALLMASTER IV sets are available in black, misty cream, and white. The CALLMASTER V is available in gray and white. The CALLMASTER VI is available only in international (charcoal) gray.

## Wiring Information on the CALLMASTER IV

The CALLMASTER IV voice terminal works in both 4-wire and 2-wire DCP configurations. The table on the next page shows pin assignments for the line cord and jack block interface

Table 13-1. The DCP Line Interface for the CALLMASTER IV

CONNECTOR BLOCK		DCP JACK INTERFACE		
Conn. Block Pin Number	D Inside Wire Color	Pin	Name	Signal Description
3	W-O	1	OD1	Balance output from telephone (power -48V) 4-wire application
			REC-1	Output to Recorder 2-wire application
4	O-W	2	OD2	Balance output from telephone (power -48V) 4-wire application
			REC-2	Output to Recorder 2-wire application
5	W-G	3	ID1	Balance input from PBX (power -48V) 4-wire application
				2-wire — unused
1	W-BL	4	REC-1	Output to Recorder 4-wire application
			U-T*	Balanced output from telephone (power -48V) 2-wire application
2	BL-W	5	REC-2	Output to Recorder 4-wire application
			U-R*	Balanced output from PBX (power 0v) 2-wire application
6	G-W	6	ID2	Balanced input from PBX (power 0v) 4-wire application
				2-wire — unused
7	W-BR	7	P1-	Adjunct power -48V (to Adjunct jack)
8	BR-W	8	P2+	Adjunct power common (to Adjunct jack)

\* U-T = "Tip"  
 U-R = "Ring"

The design of this product allows it to operate on either 2-wire or 4-wire DCP circuits. In order for the terminal to function properly in either 2-wire or 4-wire installations, there must be NO INTERCONNECTIONS between the wire pairs used for 2-wire and 4-wire operation. Bridging or paralleling of these pairs can result in damage to the terminal or can cause the PBX circuit pack to remove power to the terminal.

**REMOVE ALL CONNECTIONS BETWEEN PAIRS BEFORE CONNECTING THE TERMINAL.**

For 2-wire operation, if you need to plug the voice terminal into a 4-pin or 6-pin wall jack, instead of a standard 8-pin modular jack, refer to the "Modular Wall Jack Wiring" table on the next page to insure that the wires from the 4-pin or 6-pin wall jack are connected to the correct pins on the terminal 2-wire "LINE" jack.

4-WIRE installations MUST ONLY have PBX connections on pair 2 and pair 3 and, if necessary, auxiliary power must be connected to pair 4.

2-WIRE installations MUST ONLY have PBX connections on pair 1 and, if necessary, auxiliary power must be connected to pair 4.

**Wiring Note for the CALLMASTER VI**

---

All wiring between the DEFINITY ECS and the CALLMASTER VI, including the line cord, must consist of twisted pairs. Twisted-pair wiring makes lines less sensitive to crosstalk. The line cord must be a D8W, which consists of four twisted pairs, or a Lucent Technologies-approved equivalent.

**Distance Limitations**

---

The maximum allowable distances the CALLMASTER voice terminals can be located from the DEFINITY G1, G2, and G3, DEFINITY ECS, System 75, or System 85 cabinet is shown in the table below.

**⇒ NOTE:**

The 602 CALLMASTER can be connected to any of the switches listed directly above. However, the CALLMASTER II and CALLMASTER III are only supported when connected to a DEFINITY G3. The CALLMASTER IV is supported only when connected to a DEFINITY G3V3.

**Table 13-2. Distance Limitations for the CALLMASTER II, III, and IV Voice Terminals**  
 (See Note above for a list of supported connections for each set)

System	Port Board	Nominal Maximum Range in Feet (Meters) (See Note)	
		24 AWG	26 AWG
DEFINITY G2	SN270B	3,400 (1,034)	2,200 (671)
System 85	TN754	3,400 (1,034)	2,200 (671)
DEFINITY G1 and G3, DEFINITY ECS, and System 75	TN754	3,400 (1,034)	2,200 (671)

**Notes:**

These ranges can be extended to 5,000 feet (1524 m) for 24 AWG wire and 4,000 feet (1219 m) for 26 AWG wire with the use of a Data Link Protector. Refer to **EXPOSED PORT PROTECTION**.

In 2-wire installations, the CALLMASTER III and CALLMASTER IV can be connected to a TN2181 port board.

**Distance Limitations for the CALLMASTER V and CALLMASTER VI**

In a 2-wire installation, the CALLMASTER V and the CALLMASTER VI is connected to a TN2181 port board located in a cabinet with DEFINITY G3 Release 6.1 or later software. Use the following distance limitations between the CALLMASTER V and CALLMASTER VI and the DEFINITY ECS:

If you are using 22-gauge wire for the connection, the two pieces of equipment must be within 5,500 feet of each other; if you are using 24-gauge wire, the two must be within 3,500 feet; if you are using 26-gauge wife, the two must be within 2,200 feet.

**Power Requirements**

The CALLMASTER voice terminals receive power from the system and do not require any external power supply. However, adjunct equipment connected to the CALLMASTER II, CALLMASTER III, and CALLMASTER IV needs its own power supply.

**Switch Administration**

The 602 CALLMASTER can be used with a DEFINITY G1, G2, and G3, a DEFINITY ECS, and System 75 (R1V3) and System 85 (R2V2 through R2V4). The 602 CALLMASTER can be administered as itself.

The CALLMASTER II, CALLMASTER III, and CALLMASTER IV can be used only with a DEFINITY ECS G3V3 and above. The CALLMASTER II and CALLMASTER III must be aliased as a 602 CALLMASTER. The CALLMASTER IV voice terminal can be administered as itself.

The CALLMASTER V and CALLMASTER VI can be used only with a DEFINITY ECS Release 6.1 and later releases. The CALLMASTER V must be aliased as a 6416D+ telephone.

If the CALLMASTER VI is connected to a DEFINITY ECS switch, Release 7.1 and prior, the CALLMASTER VI must be aliased as a 603E CALLMASTER. If the CALLMASTER VI is connected to a DEFINITY ECS, Release 7.1 and later, the CALLMASTER VI can be administered as itself.

## Button Numbering

The following button diagram of the 602 CALLMASTER voice terminal will help you administer this voice terminal connected to a System 75 (R1V3 or later), a DEFINITY G1 and G3, and DEFINITY ECS, and to a System 85 (R2V2 or later) or a DEFINITY G2.

The CALLMASTER II and CALLMASTER III can be connected only to a DEFINITY G3.

The CALLMASTER IV is supported only with a DEFINITY G3V3.

The CALLMASTER V and VI are supported only with a DEFINITY G3 Release 6.1.

Figures 13-6 and 13-7 show button numbering for the 602 CALLMASTER.

Figure 13-8 shows button numbering for the CALLMASTER II and III.

Figure 13-9 shows button numbering for the CALLMASTER IV.

Figure 13-10 shows button numbering for the CALLMASTER V.

Figure 13-11 shows button numbering for the CALLMASTER VI.

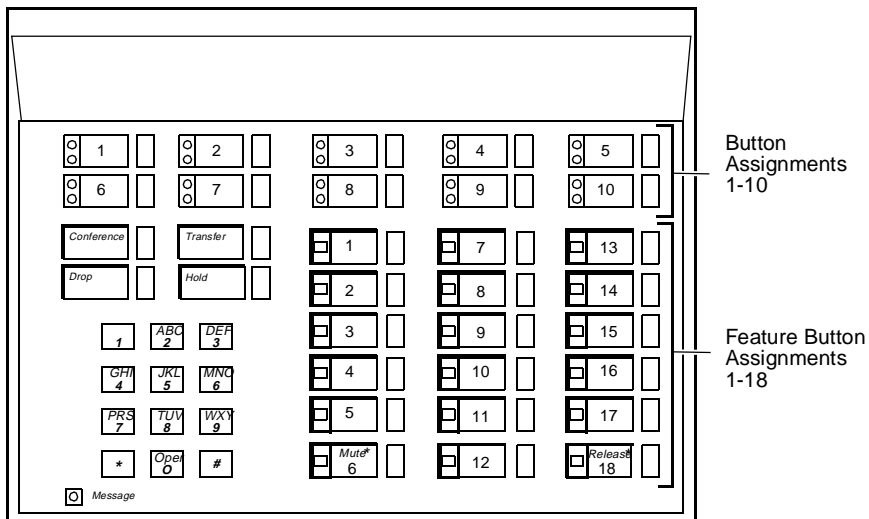

\* Feature Button #6 is preassigned as a Mute Button. It is recommended that Feature Button #18 be administered as a Release Button.

**Figure 13-6. Button Numbering for Administering the 602 CALLMASTER Voice Terminal Connected to a System 75, a DEFINITY G1 or G3, or a DEFINITY ECS**

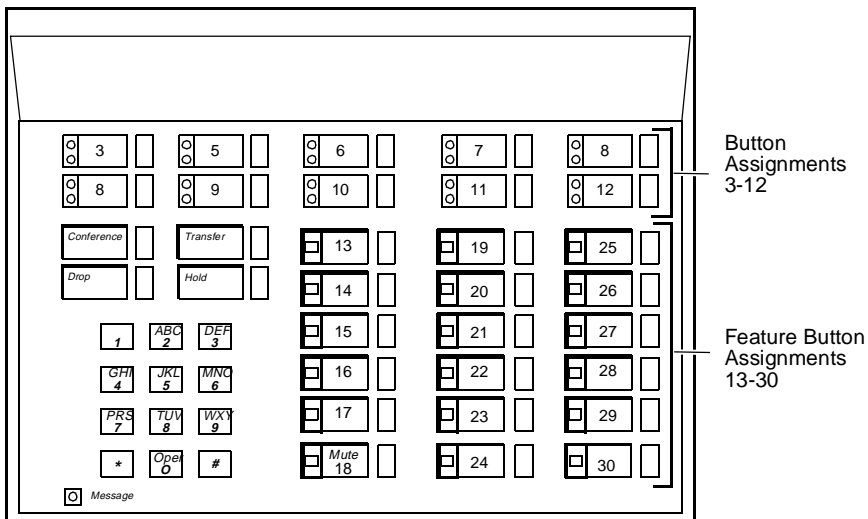

NOTE: The Hold Button is Button #1.  
 The Message Light is Button #2.  
 The Mute Button is Button #18.

Figure 13-7. Button Numbering for Administering the 602 CALLMASTER Voice Terminal Connected to a System 85 or a DEFINITY G2



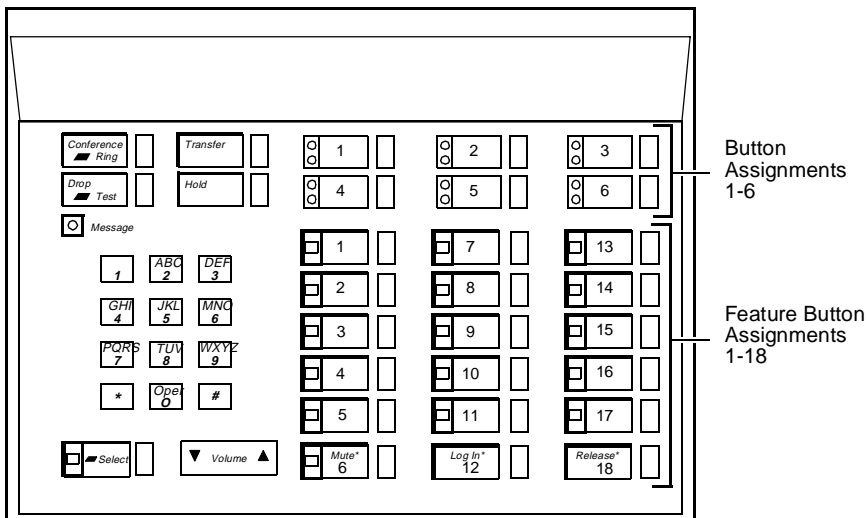

\*Feature Button #6 is preassigned as a Mute Button.  
 Administer Feature Button #12 as a  
 Log In Button and Feature Button #18  
 as a Release Button.

Figure 13-8. Button Numbering for Administering the CALLMASTER II or CALLMASTER III Voice Terminal Connected to a DEFINITY ECS G3

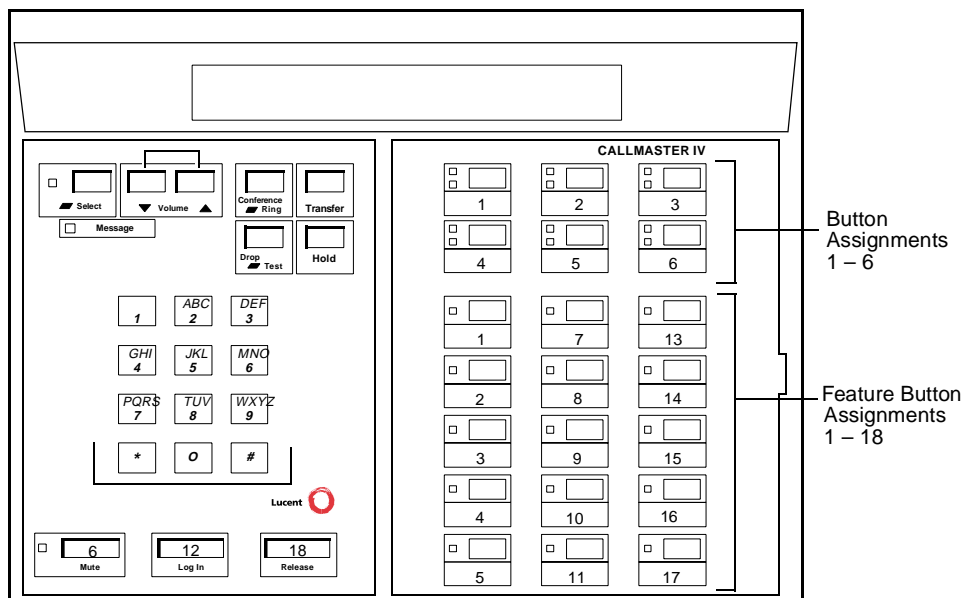
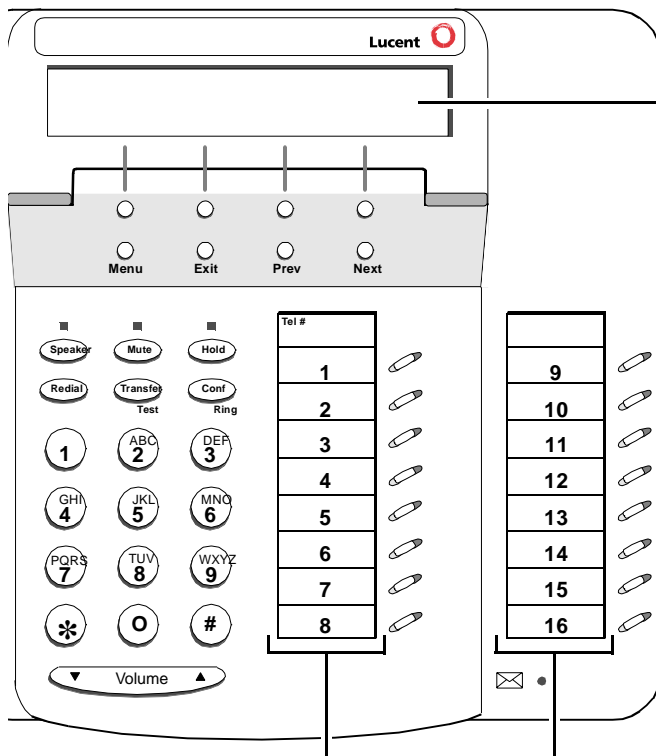

Figure 13-9. Button Numbering for Administering the CALLMASTER IV Voice Terminal Connected to a DEFINITY ECS G3V3 or Later



Administer the 12 softkey features on "SOFTKEY BUTTON ASSIGNMENTS" 1 through 12.

Administer the first column of 8 call appearance/features buttons as "BUTTON ASSIGNMENTS" 1 - 8.

Administer the second column as "FEATURE BUTTON ASSIGNMENTS" 9 - 16.

Figure 13-10. Button Numbering for Administering the CALLMASTER V Telephone Console Connected to a DEFINITY ECS Release 6.1 and Later

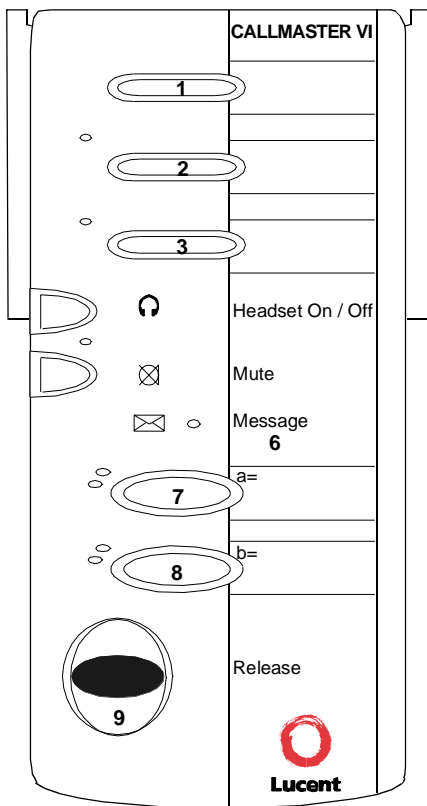

Figure 13-11. Button Numbering for Administering the CALLMASTER IV Voice Terminal Connected to a DEFINITY ECS G3 Release 6.1 or Later

### Power Failure Operation

The CALLMASTER voice terminals cannot be used as an emergency station during power failure transfer conditions.

### FCC Registration

The CALLMASTER voice terminals are not FCC registered.

## CALLMASTER Equipment PECs and Comcodes

The CALLMASTER voice terminals and optional components can be ordered with the following PECs and Comcodes:

- **Basic 602A1 CALLMASTER Voice Terminal**  
Black—3179-001 CLR03  
Misty cream—3179-001 CLR22
- **Basic 602D1 CALLMASTER Voice Terminal**  
Black—3179-002 CLR03  
Misty cream—3179-002 CLR22
- **Basic CALLMASTER II Voice Terminal with Recorder Interface**  
Black—3179-102 CLR03; Comcode: 106693294  
Misty cream—3179-102 CLR22; Comcode: 106693302  
White—3179-102 CLR10; Comcode: 107316960
- **Basic CALLMASTER III Voice Terminal without Recorder Interface**  
Black—3179-103 CLR03; Comcode: 107316978  
Misty cream—3179-103 CLR22; Comcode: 107316994  
White—3179-103 CLR10; Comcode: 107316986
- **Basic CALLMASTER IV Voice Terminal with Recorder Interface**  
Black—3179-40B CLR03; Comcode: 108010554  
Misty cream—3179-40M CLR22; Comcode: 108010570  
White—3179-40W CLR10; Comcode: 108010562
- **Basic CALLMASTER V Telephone Console (Gray only)**  
Standard English label set — PEC: 3179-50G, Comcode: 108409251  
Icon-labeled set — PEC: 3179-5GG, Comcode: 108409263
- **Basic CALLMASTER VI Voice Terminal**  
International gray— 8315-C10; Comcode: 107837544
- **EIA cable (5 feet, 9-pin, M-M) (for CALLMASTER VI)**  
Comcode: 848037743
- **CentreVu Agent Callbar software CD ROM (for CALLMASTER VI)**  
Comcode: 108090457
- **Button Designation Strips (for CALLMASTER II and III)**  
Package of 25 (silver): 846753099  
Package of 25 (international gray): 846953115  
Package of 200 (silver): 846953107  
Package of 200 (international gray): 846953123
- **Designation cards (for CALLMASTER IV)**  
Package of 25: 847933850
- **Designation cards (8-1/2" by 11") (for CALLMASTER V)**  
Package of 25: 847991650
- **Designation cards (for CALLMASTER VI)**  
Package of 25: 847948056

- **Designation card covers** (for CALLMASTER V)  
Package of 25: 108272402
- **Notepad covers** (for CALLMASTER V)  
Package of 25: 108573304
- **Notepads** (with 9 Notepads per sheet – 8-1/2" x 11")  
Package of 25: 108562570
- **Velcro strips** (for CALLMASTER VI)  
Package of 25: 847976479
- **Handset D-Kit #182083** (black, for CALLMASTER II, CALLMASTER III, and CALLMASTER IV)  
Comcode: 105514798
- **Handset D-Kit #182084** (misty cream, for CALLMASTER II, CALLMASTER III, and CALLMASTER IV)  
Comcode: 105514806
- **Handset D-Kit #182835** (white, for CALLMASTER II, CALLMASTER III, and CALLMASTER IV)  
Comcode: 107318438
- **Handset D-Kit** (gray, for CALLMASTER V)  
PEC 31293 & 31293A,  
Comcode 407904309).
- **A pull-out tray with five quick reference cards** (for CALLMASTER V)  
the tray = PEC: 33111, Comcode: 108272584;  
the cards: Comcode: 108032178).
- **XM24 Expansion Module** (with a new base angle for the 6416D+M, 6424D+M, and CALLMASTER V)  
Gray XM24 = PEC: 33071/A, Comcode: 108544511
- **Kneewell Adapter** (for 602 CALLMASTER)—31791
- **Headsets**—(See PEC 3122 for carbon compatible types)

## Adjuncts

---

The following adjunct can be used with the 602, the CALLMASTER II, CALLMASTER III, and CALLMASTER IV voice terminals:

- 7400B Plus Data Module

The following adjuncts can be used with the CALLMASTER II, CALLMASTER III, and CALLMASTER IV:

- S101A and 201A Speakerphone
- 507A Adapter
- 500A Headset Adapter (and a standard headset; see "Headsets" below)

## Headsets

A list of compatible headsets, consisting of both modular and plug prong base units and selection of headpieces, appears in "Headset Adapters" in the **Adjuncts** section later in this manual.

## Additional Documents

---

The following documents contain additional information relating to the CALLMASTER voice terminals:

- *DEFINITY Generic 2 and System 85 CALLMASTER Voice Terminal User's Guide*, 555-015-716
- *DEFINITY CALLMASTER II and CALLMASTER III Voice Terminal User and Installation Instructions*, 555-015-168
- *DEFINITY CALLMASTER IV Voice Terminal User and Installation Instructions*, 555-015-171
- *DEFINITY CALLMASTER II, CALLMASTER III, and CALLMASTER IV Instructions for Programming the Options*, 555-015-172
- *CALLMASTER V Telephone Console User's Guide*, 555-233-735
- *CALLMASTER VI Voice Terminal Version 1.0 Installation and User's Manual*, 555-015-162
- *CentreVu Agent Version 1.1 Installation and Administration*, 585-215-815
- *DEFINITY Generic 1 and Generic 3 Automatic Call Distribution (ACD) Agent Instructions*, 555-230-722
- *DEFINITY Generic 1 and Generic 3 Automatic Call Distribution (ACD) Supervisor Instructions*, 555-204-724





## The 500 and 2500 Series Telephones

# 14

---

The following 500 and 2500 Series Telephones are described in this section:

- 500-Series telephone
- 2500 DMGC telephone
- 2500 YMGK telephone
- 2500 MMGL, 2500 MMGM, 2500 YMGL, and 2500 YMGM telephones
- 2554 MMGM and 2554 YMGM telephones
- 2500 MMGN and 2500 YMGP telephones
- 2554 MMGN and 2554 YMGP telephones

## The 500 Series Telephone

---

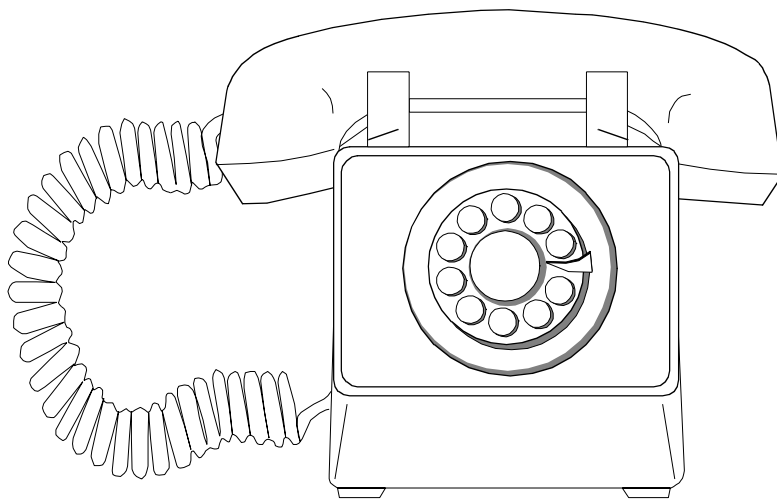

**Figure 14-1. The 500 Series Telephone**

The 500 telephone is a single appearance analog rotary dial telephone which provides cost-effective service wherever it is located. However, note that it provides limited access to features because the rotary dial has no \* or # positions.

### Applications

---

The 500 telephone can be used with the DEFINITY Communications System Generic 1, Generic 2, and Generic 3, the DEFINITY ECS, System 75, and System 85. This telephone is especially suitable for manufacturing, warehousing, guard stations, or power failure locations.

## **Physical Description**

---

### **Dimensions**



**NOTE:**

The following dimensions are approximate.

Width = 7 inches

Depth (front to back) = 8-3/4 inches

Height (maximum with handset in place) = 5-1/2 inches

### **Physical Features**

#### **Handset**

The 500 telephone is equipped with a G-type handset.

#### **Dial pad**

The 500 telephone has a 10-hole rotary dial.

#### **Jacks**

The 500 telephone housing contains two jacks. The handset cord jack is on the left side of the telephone. The line jack is on the back of the telephone. The handset contains a jack for the handset cord.

#### **Cords**

Two cords are supplied with the 500 telephone: a coiled 7-foot modular handset cord and a 7-foot modular line cord. Optional longer cords are available: a 12-foot handset cord, and 14-foot and 25-foot line cords.

#### **Ringling**

The 500 telephone has a mechanical bell type ringer. The volume control is on the bottom of the telephone.

#### **Mounting Options**

The 500 telephone can be desk mounted only.

#### **Color Options**

The 500 telephone is available in ivory, black, and beige.

## **Distance Limitations**

---

The maximum allowable distances of a 500 telephone from the DEFINITY G1, G2, and G3, DEFINITY ECS, System 75, or System 85 cabinet are shown in the table below.

**Table 14-1. Distance Limitations for the 500 Telephone**

<b>System</b>	<b>Port Board</b>	<b>Nominal Maximum Range in Feet (Meters)</b>	
		<b>24 AWG</b>	<b>26 AWG</b>
System 85	SN229	3,500 (1,067)	3,500 (1,067)
	SN228B	15,000 (4,572)	9,000 (2,743)
DEFINITY G2	SN229	3,500 (1,067)	3,500 (1,067)
	SN228B	15,000 (4,572)	9,000 (2,743)
	TN742	20,000 (6,100)	13,000 (3,962)
	TN746	3,100 (945)	2,000 (610)
DEFINITY G1 and G3, DEFINITY ECS, and System 75	TN742	20,000 (6,100)	13,000 (3,962)
	TN769	20,000 (6,100)	13,000 (3,962)
	TN746	3,100 (945)	2,000 (610)

## **Power Requirements**

---

The 500 telephone is powered by the tip and ring leads. It does not require any external power supply.

## **Power Failure Operation**

---

The 500 telephone can be used as an emergency station during power failure transfer conditions.

## **FCC Registration**

---

The 500 telephone is FCC registered.

## **500-Series Telephone Equipment PECs**

---

The 500 telephone and optional components can be ordered with the following PECs:

- Basic 500 Telephone (black) — 3100-0RD COL09
- Basic 500 Telephone (beige) — 3100-0RD COL11
- Basic 500 Telephone for use with the 4A speakerphone (black) — 3100-2RD COL09
- Basic 500 Telephone for use with the 4A speakerphone (beige) — 3100-0RD COL11
- Handset cord (12 feet, black) — 2725-01L COL09
- Line cord (14 feet, silver) — 2725-07N COL18
- Line cord (25 feet, silver) — 2725-07S COL18

## **Adjuncts**

---

The following adjuncts can be used with the optional 500SM telephone:

- 4A Speakerphone
- Z34A-WA Message Waiting Indicator

## **Additional Documents**

---

The following documents contain additional information relating to the 500 telephone:

- *DEFINITY Generic 1 and Generic 2, System 75, and System 85 Terminals and Adjuncts Installation and Test, 555-015-104*

## The 2500 Series Telephones

---

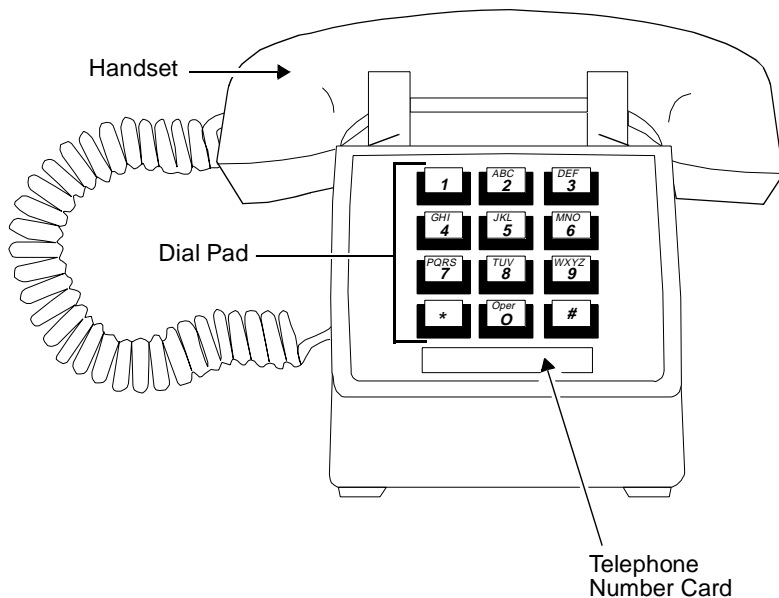

---

Figure 14-2. The 2500 Desk Model

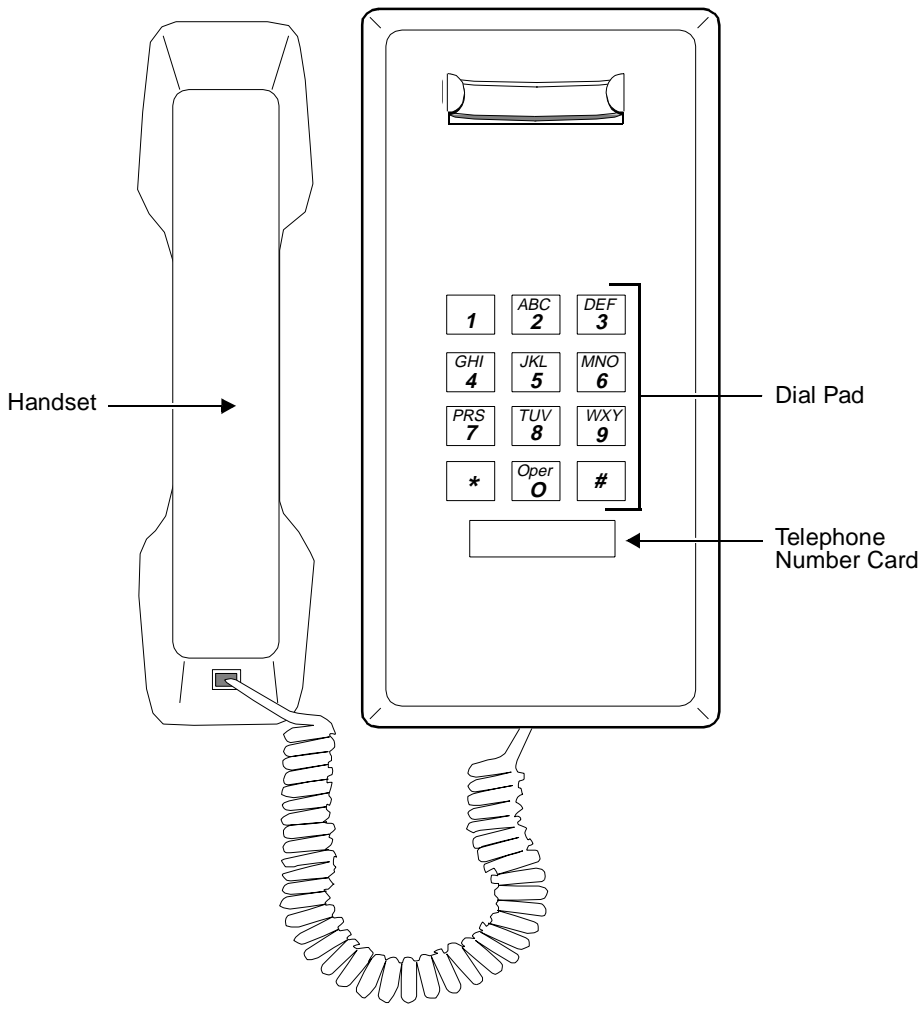
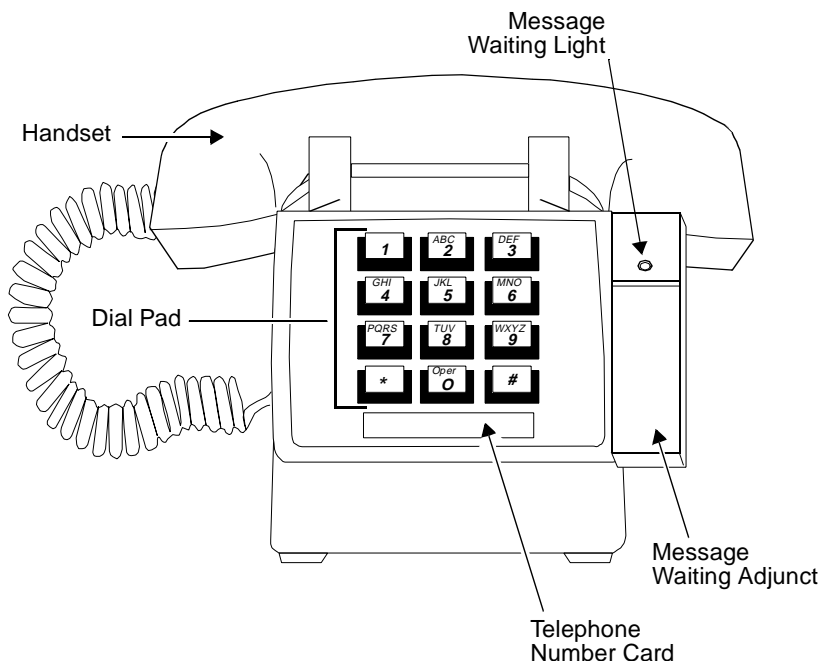

Figure 14-3. The 2554 Wall Model



**Figure 14-4. The 2500 Telephone with Message Waiting Adjunct**

The 2500 Series telephones consist of single appearance analog telephones with conventional touch-tone dialing. These telephones provide access to features through the use of the \* or # dial pad keys and the appropriate feature access codes.

The 2500 Series telephones are made up of several telephones that are basically the same but are equipped with small different attributes. The 2500 DMGC, 2500 YMGK, 2500 MMGL, 2500 MMGM, 2500 YMGL, and the 2500 YMGM are covered in separate sections of this chapter; all the others are covered here.

## Applications

The 2500 Series telephones can be used with the DEFINITY Communications System Generic 1, Generic 2, and Generic 3, the DEFINITY ECS, System 75, and System 85. This telephone is especially suitable for manufacturing, warehousing, guard stations, or power failure locations.



## Physical Description

---

### Dimensions



**NOTE:**

The following dimensions are approximate.

Width = 7 inches

Depth (front to back) = 8-3/4 inches

Height (maximum with handset in place) = 5-1/2 inches

### Features

#### RECALL button

The 2500 MMGK is equipped with a Timed Recall button. This button provides access to a second dial tone (if provided) without disconnecting the first call.

### Other Physical Features

#### Handset

Most 2500 Series telephones are equipped with a G-type handset; however, some newer versions have the hearing aid compatible K-type handset.

#### Dial pad

The 2500 Series telephone is equipped with a 12-button touch-tone dial pad.

#### Jacks

The 2500 Series telephone housing contains two jacks. The handset cord jack is on the left side of the telephone. The line cord jack is on the back of the telephone. The handset contains a jack for the handset cord. The 2514 CM contains a jack for optional equipment.

#### Cords

Two cords are supplied with the 2500 Series telephone: a coiled 7-foot modular handset cord and a 7-foot modular line cord. Optional longer cords are available: a 12-foot handset cord, and 14-foot and 25-foot line cords.

#### Ringling

The 2500 Series telephone has a bell type ringer. The volume control on the desk set is located on the bottom of the telephone. The volume control on the wall-mounted set is located on the upper right side of the telephone.

## Mounting Options

The 2500 Series telephones are all desk mounted with the exception of the 2554 MMGJ which is wall-mounted only.

## Color Options

The 2500 Series telephones are available in several colors.

- The 2500 MMGJ telephone is available in black, beige, and ivory.
- The 2500 MGK telephone is available in black and misty cream.
- The 2554 MMGJ telephone is available in black and misty cream.
- The 2500 SM telephone is available in black, beige, and ivory.
- The 2504 CM telephone is available only in ivory.
- The 2514 CM Telephone is available in black, beige, and ivory.

## Distance Limitations

The maximum allowable distances of a 2500 Series telephone from the DEFINITY G1, G2, and G3, DEFINITY ECS, System 75, or System 85 cabinet are shown in the table below.

**Table 14-2. Distance Limitations for the 2500-Series Telephones**

System	Port Board	Nominal Maximum Range in Feet (Meters)	
		24 AWG	26 AWG
System 85	SN229	3,500 (1,067)	3,500 (1,067)
	SN228B	15,000 (4,572)	9,000 (2,743)
DEFINITY G2	SN229	3,500 (1,067)	3,500 (1,067)
	SN228B	15,000 (4,572)	9,000 (2,743)
	TN742	20,000 (6,100)	13,000 (3,962)
	TN746	3,100 (945)	2,000 (610)
DEFINITY G1 and G3, DEFINITY ECS, and System 75	TN742	20,000 (6,100)	13,000 (3,962)
	TN769	20,000 (6,100)	13,000 (3,962)
	TN746	3,100 (945)	2,000 (610)

## **Power Requirements**

---

The 2500 Series telephone is powered by the tip and ring leads. It does not require any external power supply.

## **Power Failure Operation**

---

The 2500 Series telephone can be used as an emergency station during power failure transfer conditions.

## **FCC Registration**

---

The 2500 Series telephone is FCC registered.

## **2500-Series Telephone Equipment PECs**

---

The 2500 Series Voice Terminals and optional components can be ordered with the following PECs:

- 2500 MMGJ Basic Telephone (black) — 3101-EDB COL09
- 2500 MMGJ Basic Telephone (beige) — 3101-EDB COL11
- 2500 MMGJ Basic Telephone (ivory) — 3101-EDB COL12
- 2500 MGK Basic Telephone (black) — 3101-ETR COL09
- 2500 MGK Basic Telephone (misty cream) — 3101-ETR COL22
- 2554 MMGJ Basic Telephone (black) — 3101-EMW COL09
- 2554 MMGJ Basic Telephone (misty cream) — 3101-EMW COL09
- 2500 SM Basic Telephone (black) — 3101-2TD COL09
- 2500 SM Basic Telephone (beige) — 3101-2TD COL11
- 2500 SM Basic Telephone (ivory) — 3101-2TD COL12
- 2504 CM Basic Telephone (ivory) — 3100-T4W
- 2514 CM Basic Telephone (black) — 3100-TJE COL09
- 2514 CM Basic Telephone (beige) — 3100-TJE COL11
- 2514 CM Basic Telephone (ivory) — 3100-TJE COL12
- Handset cord (12 feet, black) — 2725-01L COL09
- Line cord (14 feet, silver) — 2725-07N COL18
- Line cord (25 feet, silver) — 2725-07S COL18

**14** The 500 and 2500 Series Telephones  
*The 2500 Series Telephones*

14-12

## **Adjuncts**

---

The following adjuncts can be used with the optional 2500 SM telephone:

- 4A Speakerphone
- Z34A-WA Message Waiting Indicator

## The 2500 DMGC Telephone

---

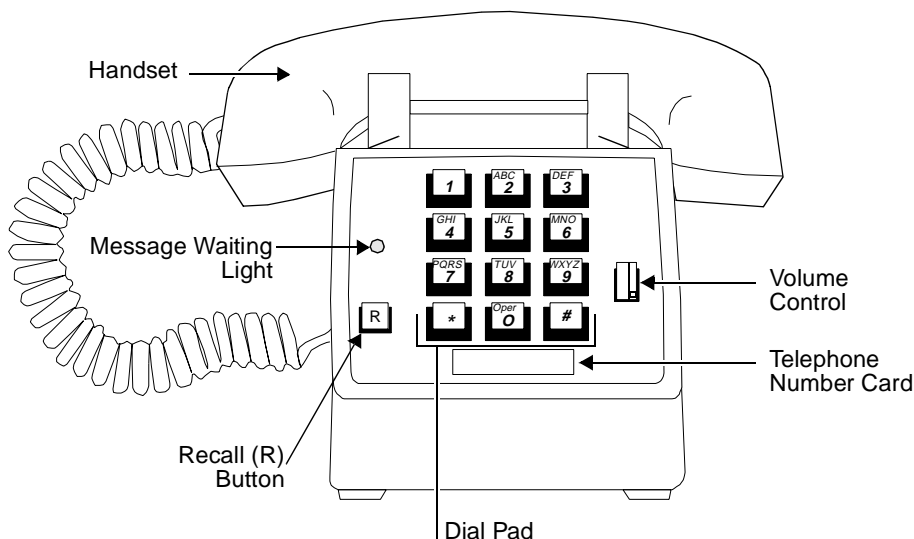

Figure 14-5. The 2500 DMGC Telephone

The 2500 DMGC telephone is a single appearance analog telephone with conventional touch-tone dialing. It provides access to features through the use of the \* or # dial pad keys and the appropriate feature access codes. The 2500 DMGC telephone is equipped with a RECALL button, Message Waiting light, and a 3-position volume control.

### Applications

---

The 2500 DMGC telephone can be used with the DEFINITY Communications System Generic 1, Generic 2, and Generic 3, the DEFINITY ECS, System 75, and System 85. This telephone is especially suitable for manufacturing, warehousing, guard stations, or power failure locations.

## Physical Description

---

### Dimensions



**NOTE:**

The following dimensions are approximate.

Width = 7 inches

Depth (front to back) = 8-3/4 inches

Height (maximum with handset in place) = 5-1/2 inches

### Features

#### **RECALL button**

The RECALL button performs the same function as flashing the switchhook.

#### **Message light**

The red Message light blinks when you have a message.

### Other Physical Features

#### **Handset**

The 2500 DMGC telephone is equipped with a G-type handset.

#### **Dial pad**

The 2500 DMGC telephone has a 12-button touch-tone dial pad.

#### **Jacks**

The 2500 DMGC telephone housing contains two jacks. The handset cord jack is on the left side of the telephone. (The handset contains a jack for the other end of the handset cord.) The line jack is on the back of the telephone.

#### **Cords**

Two cords are supplied with the 2500 DMGC telephone: a coiled 7-foot modular handset cord and a 7-foot modular line cord. Optional longer cords are available: a 12-foot handset cord, and 14-foot and 25-foot line cords.

#### **Ringling**

The 2500 DMGC has electronic tone ringling. The 3-position volume control is located on the faceplate of the telephone.

### **Mounting Options**

The 2500 DMGC telephone can only be desk-mounted.

### **Color Options**

The 2500 DMGC telephone is available in black or ivory.

### **Distance Limitations**

The maximum allowable distances of a 2500 DMGC telephone from the DEFINITY G1, G2, and G3, DEFINITY ECS, System 75, or System 85 cabinet are shown in the table below.

**Table 14-3. Distance Limitations for the 2500 DMGC Telephone**

<b>System</b>	<b>Port Board</b>	<b>Nominal Maximum Range in Feet (Meters)</b>	
		<b>24 AWG</b>	<b>26 AWG</b>
System 85	SN229	3,500 (1,067)	3,500 (1,067)
	SN228B	15,000 (4,572)	9,000 (2,743)
DEFINITY G2	SN229	3,500 (1,067)	3,500 (1,067)
	SN228B	15,000 (4,572)	9,000 (2,743)
	TN742	20,000 (6,100)	13,000 (3,962)
	TN746	3,100 (945)	2,000 (610)
DEFINITY G1 and G3, DEFINITY ECS, and System 75	TN742	20,000 (6,100)	13,000 (3,962)
	TN769	20,000 (6,100)	13,000 (3,962)
	TN746	3,100 (945)	2,000 (610)

### **Power Requirements**

The 2500 DMGC telephone is powered by the tip and ring leads. It does not require any external power supply.

### **Power Failure Operation**

The 2500 DMGC telephone can be used as an emergency station during power failure transfer conditions.

### **FCC Registration**

The 2500 DMGC telephone is FCC registered.

## **2500 DMGC Equipment PECs**

---

The 2500 DMGC Voice Terminals and optional components can be ordered with the following PECs:

- 2500 DMGC Basic Telephone (black) — 3178-SYSB
- 2500 DMGC Basic Telephone (ivory) — 3178-SYSI
- Handset cord (12 feet, black) — 2725-01L COL09
- Line cord (14 feet, silver) — 2725-07N COL18
- Line cord (25 feet, silver) — 2725-07S COL18

## **Adjuncts**

---

The 2500 DMGC telephone is not compatible with any adjuncts.

## **Additional Documents**

---

The following documents contain additional information relating to the 2500 DMGC telephone:

- *DEFINITY Generic 1 and Generic 2, System 75, and System 85 Terminals and Adjuncts Installation and Test, 555-015-104*



## The 2500 YMGK Telephone

---

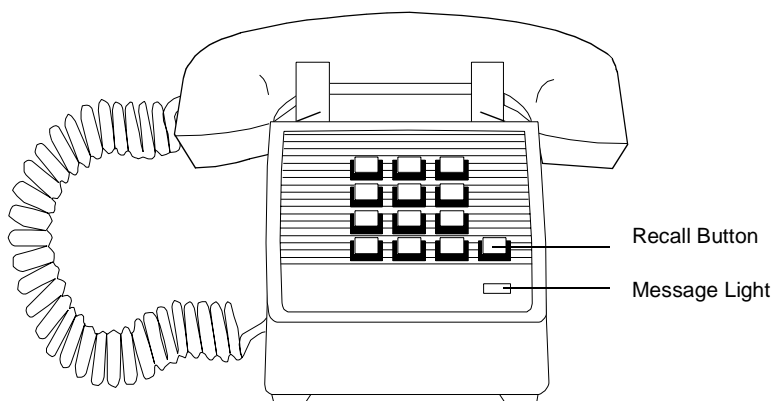

---

Figure 14-6. The 2500 YMGK Telephone

The 2500 YMGK telephone is a single appearance analog telephones with conventional touch-tone dialing. It is equipped with a RECALL button and a Message Waiting light. It provides access to features through the use of the \* or # dial pad keys and the appropriate feature access codes.

### Applications

---

The 2500 YMGK telephone can be used with the DEFINITY Communications System Generic 1, Generic 2, and Generic 3, the DEFINITY ECS, System 75, and System 85. This telephone is especially suitable for manufacturing, warehousing, guard stations, or power failure locations.

## Physical Description

---

### Dimensions



**NOTE:**

The following dimensions for the 2500 YMGK telephone are approximate.

Width = 7 inches

Depth (front to back) = 8-3/4 inches

Height (maximum with handset in place) = 5-1/2 inches

### Features

#### RECALL button

The RECALL button performs the same function as flashing the switchhook.

#### Message light

The red Message light flashes when a message has been left, and flutters when a call is being received.

### Other Physical Features

#### Handset

The 2500 YMGK telephone is equipped with a K-type handset.

#### Dial Pad

The 2500 YMGK telephone has a 12-button touch-tone dial pad.

#### Jacks

The 2500 YMGK telephone housing contains two jacks. The handset cord jack is on the left side of the telephone. (The handset contains a jack for the other end of the handset cord.) The line jack is on the back of the telephone.

#### Cords

Two cords are supplied with the 2500 YMGK telephone: a coiled 7-foot modular handset cord and a 7-foot modular line cord. Optional longer cords are available: a 12-foot handset cord, and 14-foot and 25-foot line cords.

## Ringling

The 2500 YMGK telephone has electronic tone ringer. The volume control is located on the bottom of the telephone.

## Mounting Options

The 2500 YMGK telephone is desk-mounted.

## Color Options

The 2500 YMGK telephone is available in black or misty cream.

## Distance Limitations

The maximum allowable distances of a 2500 YMGK telephone from the DEFINITY G1, G2, and G3, DEFINITY ECS, System 75, or System 85 cabinet are shown in the table below.

**Table 14-4. Distance Limitations for the 2500 YMGK Telephone**

System	Port Board	Nominal Maximum Range in Feet (Meters)	
		24 AWG	26 AWG
System 85	SN229	3,500 (1,067)	3,500 (1,067)
	SN228B	15,000 (4,572)	9,000 (2,743)
DEFINITY G2	SN229	3,500 (1,067)	3,500 (1,067)
	SN228B	15,000 (4,572)	9,000 (2,743)
	TN742	20,000 (6,100)	13,000 (3,962)
	TN746	3,100 (945)	2,000 (610)
DEFINITY G1 and G3, DEFINITY ECS, and System 75	TN742	20,000 (6,100)	13,000 (3,962)
	TN769	20,000 (6,100)	13,000 (3,962)
	TN746	3,100 (945)	2,000 (610)

## Power Requirements

The 2500 YMGK telephone is powered by the tip and ring leads. It does not require any external power supply.

## **Power Failure Operation**

---

The 2500 YMGK telephone can be used as an emergency station during power failure transfer conditions.

## **FCC Registration**

---

The 2500 YMGK telephone's FCC registration number is AS593M-17899-TE-T.

## **2500 YMGK Equipment PECs**

---

The 2500 YMGK telephones and optional components can be ordered with the following PECs:

- 2500 YMGK Basic Telephone (black) — 3178-NHL COL003
- 2500 YMGK Basic Telephone (misty cream) — 3178-NHL COL022
- Handset cord (12 feet, black) — 2725-01L COL09
- Line cord (14 feet, silver) — 2725-07N COL18
- Line cord (25 feet, silver) — 2725-07S COL18

## **Adjuncts**

---

The 2500 YMGK telephone is not compatible with any adjuncts.

## **Additional Documents**

---

The following documents contain additional information relating to the 2500 YMGK telephone:

- *DEFINITY Generic 1 2500 YMGK User's Guide*, 555-204-734
- *System 75 2500 YMGK User's Guide*, 555-200-734
- *DEFINITY Generic 2 and System 85 2500 YMGK User's Guide*, 555-104-717

14 The 500 and 2500 Series Telephones

The 2500 MMGL and 2500 YMGL, 2500 MMGM and 2500 YMGM, and 2554

14-21

## The 2500 MMGL and 2500 YMGL, 2500 MMGM and 2500 YMGM, and 2554 MMGM and 2554 YMGM Telephones

---

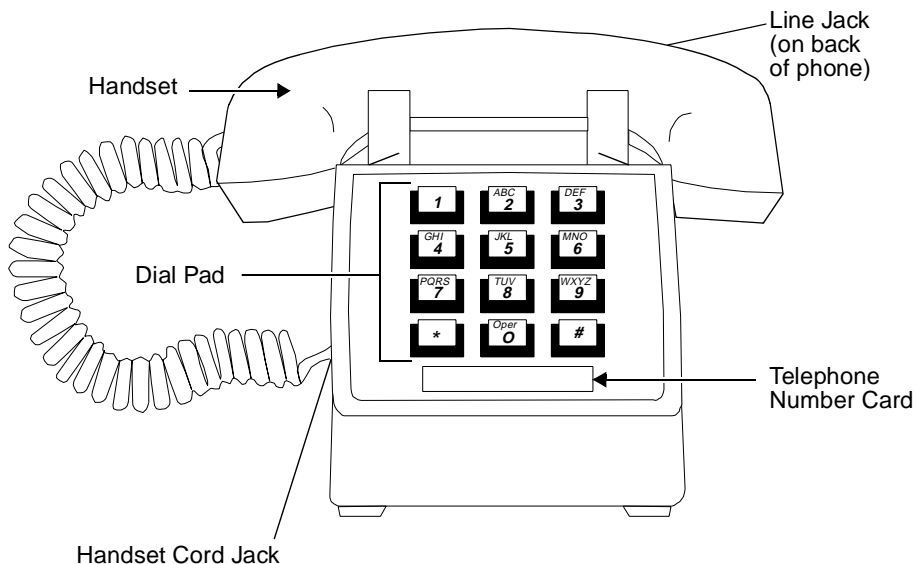

---

Figure 14-7. The 2500 MMGL and 2500 MMGM Telephones

14 The 500 and 2500 Series Telephones

The 2500 MMGL and 2500 YMGL, 2500 MMGM and 2500 YMGM, and 2554

14-22

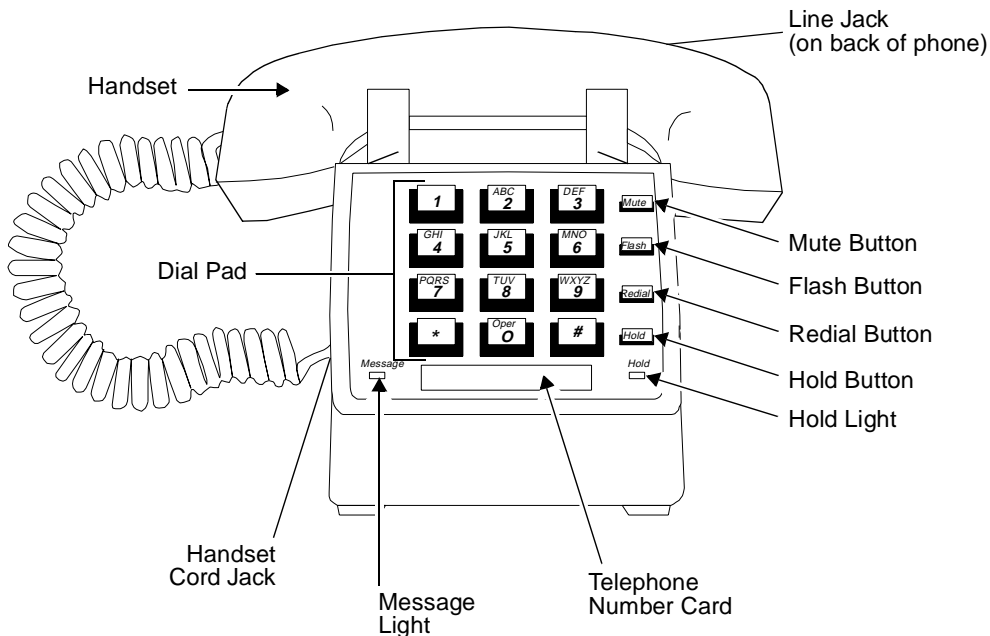
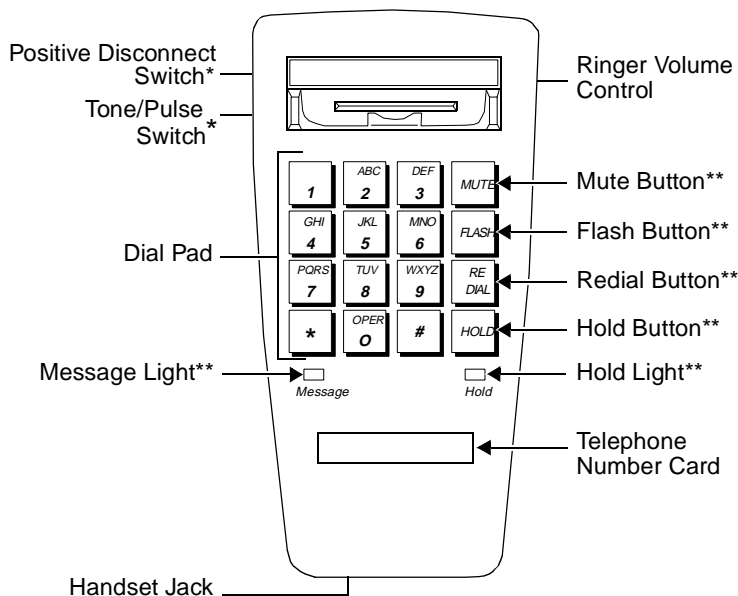

Figure 14-8. The 2500 YMGL and 2500 YMGM Telephones

14 The 500 and 2500 Series Telephones

The 2500 MMGL and 2500 YMGL, 2500 MMGM and 2500 YMGM, and 2554

14-23



\*\* These five buttons and the Message light appear ONLY on the 2554 YMGM.

Figure 14-9. The 2554 MMGM and 2554 YMGM Wall-Model Telephones

Like earlier 2500 Series telephones, the 2500 MMGL, 2500 YMGL, 2500 MMGM, and 2500 YMGM desk model telephones, and the 2554 MMGM and 2554 YMGM wall model telephones are single appearance analog telephones with conventional touch-tone dialing. The 2500 MMGL, 2500 MMGM, and 2554 MMGM telephones have NO feature buttons. The 2500 YMGL, 2500 YMGM, and 2554 YMGM telephones are equipped with a FLASH button, a Message Waiting light, a REDIAL button, a HOLD button, and a MUTE button. All six of these telephone models provide access to features through the use of the \* or # dial pad keys and the appropriate feature access codes.

On all of these telephones, the user can select either Touch-Tone or Pulse dialing, whichever is appropriate. There is also a 2-position Positive Disconnect Switch which ensures faster, cleaner termination of calls when the user presses the switchhook.

**⇒ NOTE:**

All other 2500 telephones previously available will be manufacture discontinued beginning in June, 1994. The 2500 MMGL and 2500 YMGL will be discontinued as of June, 1996, and the 2500 MMGM and 2500 YMGM, which took their place, will, in turn, be discontinued in December, 1999.

**14 The 500 and 2500 Series Telephones**

*The 2500 MMGL and 2500 YMGL, 2500 MMGM and 2500 YMGM, and 2554*

14-24

## **Applications**

---

The 2500 MMGL, 2500 YMGL, 2500 MMGM, 2500 YMGM, 2554 MMGM, and 2554 YMGM telephones can be used with the DEFINITY Communications System Generic 1, Generic 2, and Generic 3, the DEFINITY ECS, System 75, and System 85. These 2500 Series telephones are especially suitable for manufacturing, warehousing, guard stations, or power failure locations.

## **Physical Description**

---

### **Dimensions**

 **NOTE:**

The following dimensions for the four 2500 desk models are approximate.

Width = 5.37 inches

Depth (front to back) = 9 inches

Height (maximum with handset in place) = 3.81 inches

 **NOTE:**

The following dimensions for the two 2554 wall models are approximate.

Width = 4 inches

Depth (front to back) = 8.5 inches

Height (maximum with handset in place) = 4.5 inches

### **Features on the 2500 YMGL, 2500 YMGM, and 2554 YMGM Telephones**

The 2500 YMGL, 2500 YMGM, and 2554 YMGM telephones have four fixed feature buttons:

- MUTE button
- FLASH button
- REDIAL button
- HOLD button

#### **MUTE button**

Pressing and holding the MUTE button down blocks your conversation from being heard by the other party.



**14 The 500 and 2500 Series Telephones**

*The 2500 MMGL and 2500 YMGL, 2500 MMGM and 2500 YMGM, and 2554*

14-25

### **FLASH button**

The FLASH button performs the same function as flashing the switchhook; that is, it provides access to system features or use of custom calling services that require a press of the switchhook.

### **REDIAL button**

The REDIAL button is used to dial the last number dialed (up to 28 digits).

### **HOLD button**

The HOLD button is used to put a call on hold. Below the HOLD button, there is a red light. When the user puts a call on hold, the light goes on.

### **Message light**

The red Message light flashes when a message has been left, and flutters when a call is being received. The telephones recognize either LED or neon message waiting signals.

## **Other Physical Features** **(on All of these 2500 and 2554 Telephones)**

### **Positive Disconnect**

The Positive Disconnect switch on the bottom of the telephone has two positions: ON and OFF.

- The ON position hangs up the telephone for approximately two seconds, even if the switchhook depression is less. This prevents inadvertent switchhook flashes. To initiate switchhook flash in this mode, press the FLASH button.
- In the OFF position, the switchhook will function normally.

### **Handset**

All of these 2500 Series telephones are equipped with a K-type handset.

### **Dial Pad**

All of these 2500 Series telephones are equipped with a 12-button touch-tone dial pad. On all telephones, the letters "Q" and "Z" have been added to the appropriate dial pad keys, and the "5" button on the dial pad has raised bars for visually-impaired users.

### **Jacks**

All of these 2500 Series telephones contain two jacks. The handset cord jack is on the left side of the telephone. (The handset also contains a jack for the other end of the handset cord.) The line cord jack is on the right rear of the set.

## Cords

Two cords are supplied with all four of these 2500 Series model telephones: a coiled 6-foot modular handset cord and a 7-foot modular line cord. Optional longer cords are available: a 12-foot handset cord, and 14-foot and 25-foot line cords.

## Ringling

All of these 2500 Series telephones have an electronic tone ringer. There is a 3-position ringer volume control located on the bottom of the telephone.

## Mounting Options

The 2500 MMGL, 2500 MMGM, 2500 YMGL, and 2500 YMGM telephones can only be desk-mounted. They *cannot* be wall-mounted. The 2554 MMGM and 2554 YMGM telephones are wall model telephones.

## Color Options

All of these 2500 Series telephones are available in black or misty cream.

## Distance Limitations

The maximum allowable distances of a 2500 telephone from the DEFINITY G1, G2, and G3, DEFINITY ECS, System 75, or System 85 cabinet are shown in the table below.

**Table 14-5. Distance Limitations for the 2500 MMGL, 2500 YMGL, 2500 MMGM, 2500 YMGM, 2554 MMGM, and 2554 YMGM Telephones**

System	Port Board	Nominal Maximum Range in Feet (Meters)	
		24 AWG	26 AWG
SYSTEM 85	SN229	3,500 (1,067)	3,500 (1,067)
	SN228B	15,000 (4,572)	9,000 (2,743)
DEFINITY G2	SN229	3,500 (1,067)	3,500 (1,067)
	SN228B	15,000 (4,572)	9,000 (2,743)
	TN742	20,000 (6,100)	13,000 (3,962)
	TN746	3,100 (945)	2,000 (610)
	TN746B	3,100 (945)	2,000 (610)
DEFINITY G1 and G3, DEFINITY ECS, and System 75	TN742	20,000 (6,100)	13,000 (3,962)
	TN769	20,000 (6,100)	13,000 (3,962)
	TN746	3,100 (945)	2,000 (610)

**14 The 500 and 2500 Series Telephones**

*The 2500 MMGL and 2500 YMGL, 2500 MMGM and 2500 YMGM, and 2554*

14-27

## **Power Requirements**

---

All of these 2500 Series telephones are powered by the tip and ring leads. These telephones do not require any external power supply.

## **Switch Administration**

---

These 2500 series telephones must be administered in the following ways:

- If the 2500 MMGL, 2500 YMGL, 2500 MMGM, 2500 YMGM, 2554 MMGM, or 2554 YMGM telephone is connected to a System 75, DEFINITY G1 or G3, or a DEFINITY ECS, it must be administered as a 2500 analog telephone.
- If any of these 2500 Series telephones is connected to a System 85 or a DEFINITY G2, it can be administered as an analog line.

## **Power Failure Operation**

---

All of these 2500 Series telephones can be used as an emergency station during power failure transfer conditions.

## **FCC Registration**

---

These 2500 telephones are FCC-registered.

## **UL and CSA Approval**

---

These telephones have been tested and have met the Underwriters Laboratories (UL) Standards UL 1459 and have also met the Canadian Standards Association (CSA) Standards CSA-C22.2 No.225-M90.

## **Hearing Aid Compatible**

---

These telephones are compatible with the inductively coupled hearing aids prescribed by the FCC.

14 The 500 and 2500 Series Telephones

*The 2500 MMGL and 2500 YMGL, 2500 MMGM and 2500 YMGM, and 2554*

14-28

## 2500 MMGL and 2500 YMGL Equipment PECs

The 2500 MMGL and 2500 YMGL telephones can no longer be ordered. The 2500 MMGM and 2500 YMGM, and the 2554 MMGM and 2554 YMGM telephones and optional components can be ordered with the following PECs:

- 2500 MMGM Basic Telephone (black) — 3101-KBD COL003
- 2500 MMGM Basic Telephone (misty cream) — 3101-KBD COL022
- 2500 YMGM Basic Telephone (black) — 3101-KFD COL003
- 2500 YMGM Basic Telephone (misty cream) — 3101-KFD COL022
- 2554 MMGM Basic Telephone (black) — 3101-KBW COL003
- 2554 MMGM Basic Telephone (misty cream) — 3101-KBW COL022
- 2554 YMGM Basic Telephone (black) — 3101-KFW COL003
- 2554 YMGM Basic Telephone (misty cream) — 3101-KFW COL022
- Handset cord (12 feet, black) — 2725-01L COL09
- Handset cord (12 feet, misty cream) — 2725-01L COL022
- Line cord (14 feet, silver) — 2725-07N COL18
- Line cord (25 feet, silver) — 2725-07S COL18

## Additional Documents

The following document contains additional information relating to the 2500 MMGM and 2500 YMGM telephone, and the 2554 MMGM and 2554 YMGM telephone: (This document is shipped with these telephones, but is not orderable.)

- *2500 MMGM and 2500 YMGM Telephones, and the 2554 MMGM and 2554 YMGM Telephones Quick Reference Guide*

14 The 500 and 2500 Series Telephones

The 2500 MMGN and 2500 YMGP and 2554 MMGN and 2554 YMGP Telephones

14-29

## The 2500 MMGN and 2500 YMGP and 2554 MMGN and 2554 YMGP Telephones

---

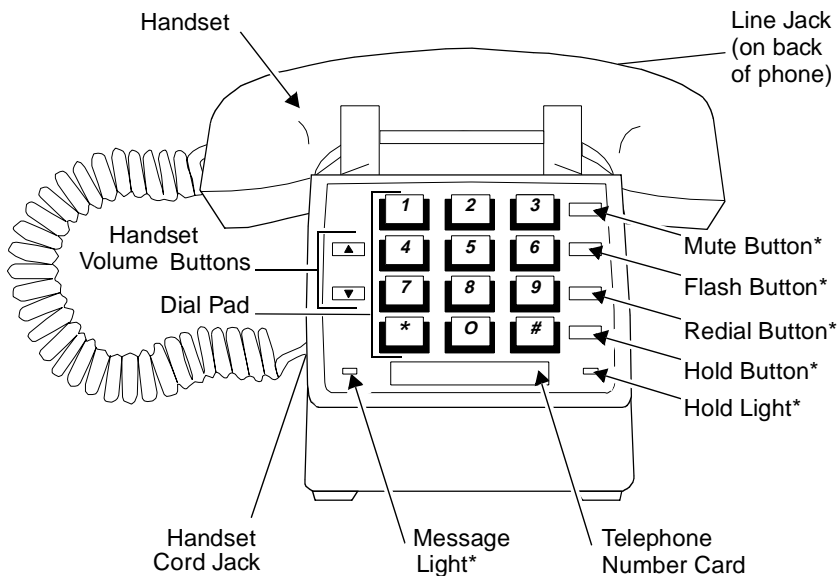

\* These buttons and lights appear ONLY on the 2500 YMGP.

---

Figure 14-10. The 2500 MMGN and 2500 YMGP Telephones

14 The 500 and 2500 Series Telephones

The 2500 MMGN and 2500 YMGP and 2554 MMGN and 2554 YMGP Telephones

14-30

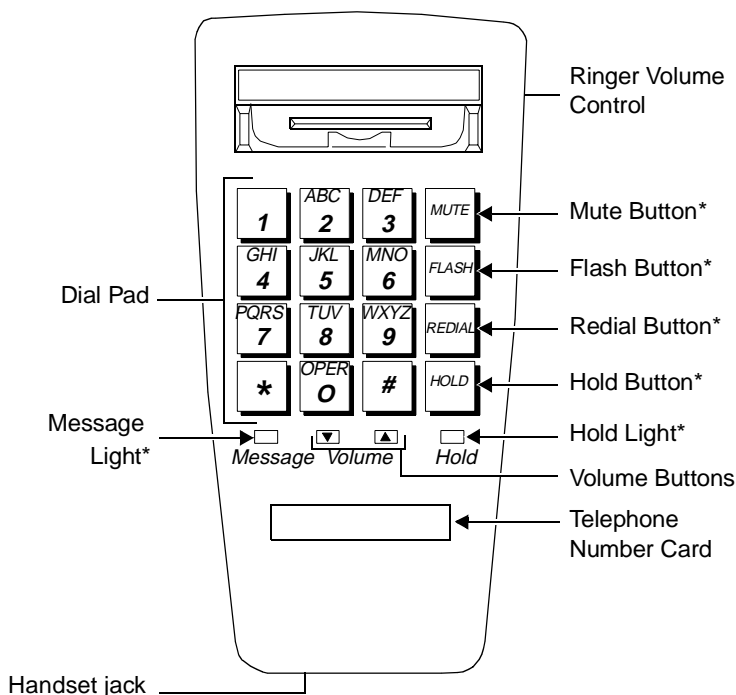

\* These five buttons and the Message light appear ONLY on the 2554 YMGP.

Figure 14-11. The 2554 MMGN and 2554 YMGP Wall-Model Telephones

The newest 2500 telephones are the 2500 MMGN and 2500 YMGP desk model telephones, and the 2554 MMGN and 2554 YMGP wall model telephones. These models will take the place of the 2500 MMGM, 2500 YMGM, 2554 MMGM, and 2554 YMGM, which will be discontinued as of December 31, 1999.

Like the original 2500 sets, these new 2500 telephones are single appearance analog telephones with conventional touch-tone dialing. The 2500 MMGN and 2554 MMGN telephones have NO feature buttons. The 2500 YMGP and 2554 YMGP telephones are equipped with a FLASH button, a Message Waiting light, a REDIAL button, a HOLD button, and a MUTE button. All six of these telephone models provide access to features through the use of the \* or # dial pad keys and the appropriate feature access codes.

These 2500 Series telephones are automatically set for touch-tone dialing. The Positive Disconnect feature, which ensures faster, cleaner termination of calls when the user presses the switchhook, is also set at the factory.

<b>14</b> The 500 and 2500 Series Telephones <i>The 2500 MMGN and 2500 YMGP and 2554 MMGN and 2554 YMGP Telephones</i>	<b>14-31</b>
---	--------------

## **Applications**

---

The 2500 MMGN, 2500 YMGP, 2554 MMGN, and 2554 YMGP telephones can be used with the DEFINITY Communications System Generic 1, Generic 2, and Generic 3, the DEFINITY ECS, System 75, and System 85. These 2500 Series telephones are especially suitable for manufacturing, warehousing, guard stations, or power failure locations.

## **Physical Description**

---

### **Dimensions**

#### **NOTE:**

The following dimensions for the four 2500 desk models are approximate.

Width = 5.37 inches

Depth (front to back) = 9 inches

Height (maximum with handset in place) = 3.81 inches

#### **NOTE:**

The following dimensions for the two 2554 wall models are approximate.

Width = 4 inches

Depth (front to back) = 8.5 inches

Height (maximum with handset in place) = 4.5 inches

### **Features on the 2500 YMGP and 2554 YMGP Telephones**

The 2500 YMGP and 2554 YMGP telephones have four fixed feature buttons:

- MUTE button
- FLASH button
- REDIAL button
- HOLD button

#### **MUTE button**

Pressing and holding the MUTE button down blocks your conversation from being heard by the other party.

<b>14</b>	The 500 and 2500 Series Telephones <i>The 2500 MMGN and 2500 YMGP and 2554 MMGN and 2554 YMGP Telephones</i>	14-32
-----------	---	-------

### **FLASH button**

The FLASH button performs the same function as flashing the switchhook; that is, it provides access to system features or use of custom calling services that require a press of the switchhook.

### **REDIAL button**

The REDIAL button is used to dial the last number dialed (up to 28 digits).

### **HOLD button**



The HOLD button is used to put a call on hold. Below the HOLD button, there is a red light. When the user puts a call on hold, the light goes on.

### **Message light**

The red Message light flashes when a message has been left, and flutters when a call is being received. The telephones recognize either LED or neon message waiting signals.

## **Other Physical Features** **(on All of these 2500 and 2554 Telephones)**

### **Handset Volume Buttons**

All of these 2500 Series telephone models have two handset volume control buttons which control the receive volume of the handset. To raise the volume, press ; to lower the volume, press .

### **Handset**

All of these 2500 Series telephones are equipped with a K-type handset.

### **Dial Pad**

All of these 2500 Series telephones are equipped with a 12-button touch-tone dial pad. On all telephones, the letters "Q" and "Z" have been added to the appropriate dial pad keys, and the "5" button on the dial pad has raised bars for visually-impaired users.

### **Jacks**

All of these 2500 Series telephones contain two jacks. The handset cord jack is on the left side of the telephone. (The handset also contains a jack for the other end of the handset cord.) The line cord jack is on the right rear of the set.

### **Cords**

Two cords are supplied with all four of these 2500 Series model telephones: a coiled 6-foot modular handset cord and a 7-foot modular line cord. Optional longer cords are available: a 12-foot handset cord, and 14-foot and 25-foot line cords.



**14** The 500 and 2500 Series Telephones

*The 2500 MMGN and 2500 YMGP and 2554 MMGN and 2554 YMGP Telephones*

14-33

### Ringling

All of these 2500 Series telephones have an electronic tone ringer. There is a 3-position ringer volume control located on the bottom of the telephone. There are three settings on the volume control: High, Low, and Off.

### Mounting Options

The 2500 MMGN and 2500 YMGP telephones can only be desk-mounted. They *cannot* be wall-mounted. The 2554 MMGN and 2554 YMGP telephones are wall model telephones.

### Color Options

All of these 2500 Series telephones are available in black or misty cream.

## Distance Limitations

The maximum allowable distances of a 2500 telephone from the DEFINITY G1, G2, and G3, DEFINITY ECS, System 75, or System 85 cabinet are shown in the table below.

**Table 14-6. Distance Limitations for the 2500 MMGN, 2500 YMGP, 2554 MMGN, and 2554 YMGP Telephones**

System	Port Board	Nominal Maximum Range in Feet (Meters)	
		24 AWG	26 AWG
SYSTEM 85	SN229	3,500 (1,067)	3,500 (1,067)
	SN228B	15,000 (4,572)	9,000 (2,743)
DEFINITY G2	SN229	3,500 (1,067)	3,500 (1,067)
	SN228B	15,000 (4,572)	9,000 (2,743)
	TN742	20,000 (6,100)	13,000 (3,962)
	TN746	3,100 (945)	2,000 (610)
	TN746B	3,100 (945)	2,000 (610)
DEFINITY G1 and G3, DEFINITY ECS, and System 75	TN742	20,000 (6,100)	13,000 (3,962)
	TN769	20,000 (6,100)	13,000 (3,962)
	TN746	3,100 (945)	2,000 (610)

## Power Requirements

All of these 2500 Series telephones are powered by the tip and ring leads. These telephones do not require any external power supply.

<b>14</b> The 500 and 2500 Series Telephones <i>The 2500 MMGN and 2500 YMGP and 2554 MMGN and 2554 YMGP Telephones</i>	<b>14-34</b>
---	--------------

## **Switch Administration**

---

These 2500 series telephones must be administered in the following ways:

- If the 2500 MMGN, 2500 YMGP, 2554 MMGN, or 2554 YMGP telephone is connected to a System 75, DEFINITY G1 or G3, or a DEFINITY ECS, it must be administered as a 2500 analog telephone.
- If any of these 2500 Series telephones is connected to a System 85 or a DEFINITY G2, it can be administered as an analog line.

## **Power Failure Operation**

---

All of these 2500 Series telephones can be used as an emergency station during power failure transfer conditions.

## **FCC Registration**

---

These 2500 telephones are FCC-registered.

## **UL and CSA Approval**

---

These telephones have been tested and have met the Underwriters Laboratories (UL) Standards UL 1459 and have also met the Canadian Standards Association (CSA) Standards CSA-C22.2 No.225-M90.

## **Hearing Aid Compatible**

---

These telephones are compatible with the inductively coupled hearing aids prescribed by the FCC.

14 The 500 and 2500 Series Telephones

*The 2500 MMGN and 2500 YMGP and 2554 MMGN and 2554 YMGP Telephones*

14-35

## 2500 MMGN and 2500 YMGP Equipment PECs

The 2500 MMGN, 2500 YMGP, 2554 MMGN, and 2554 YMGP telephones and optional components can be ordered with the following PECs:

- 2500 MMGN Basic Telephone  
Black set — PEC: 3101-KBD COL003  
Comcode: 108209016  
Misty cream set — PEC: 3101-KBD COL215  
Comcode: 108209024
- 2500 YMGP Basic Telephone  
Black set — PEC: 3101-KFD COL003  
Comcode: 108209032  
Misty cream set — PEC: 3101-KFD COL215  
Comcode: 108209040
- 2554 MMGN Basic Telephone  
Black set — PEC: 3101-KBW COL003  
Comcode: 108209057  
Misty cream set — PEC: 3101-KBW COL215  
Comcode: 108209065
- 2554 YMGP Basic Telephone  
Black set — PEC: 3101-KFW COL003  
Comcode: 108209073  
Misty cream set — PEC: 3101-KFW COL215  
Comcode: 108209081
- Handset cord (12 feet, black) — 2725-01L COL09
- Handset cord (12 feet, misty cream) — 2725-01L COL022
- Line cord (14 feet, silver) — 2725-07N COL18
- Line cord (25 feet, silver) — 2725-07S COL18

## Additional Documents

The following document contains additional information relating to the 2500 MMGN, 2500 YMGP, 2554 MMGN, and 2554 YMGP telephones: (This document is shipped with these telephones, but is not orderable.)

- *2500 MMGN and 2500 YMGP Telephones and the 2554 MMGN and 2554 YMGP Telephones Quick Reference*

<b>14</b>	The 500 and 2500 Series Telephones <i>The 2500 MMGN and 2500 YMGP and 2554 MMGN and 2554 YMGP Telephones</i>	<b>14-36</b>
-----------	---	--------------

## The 6200 Series Telephones

# 15

---

The following 6200 Series telephones are described in this section:

- 6210 telephone
- 6218 telephone
- 6220 telephone

## The 6210 Telephone

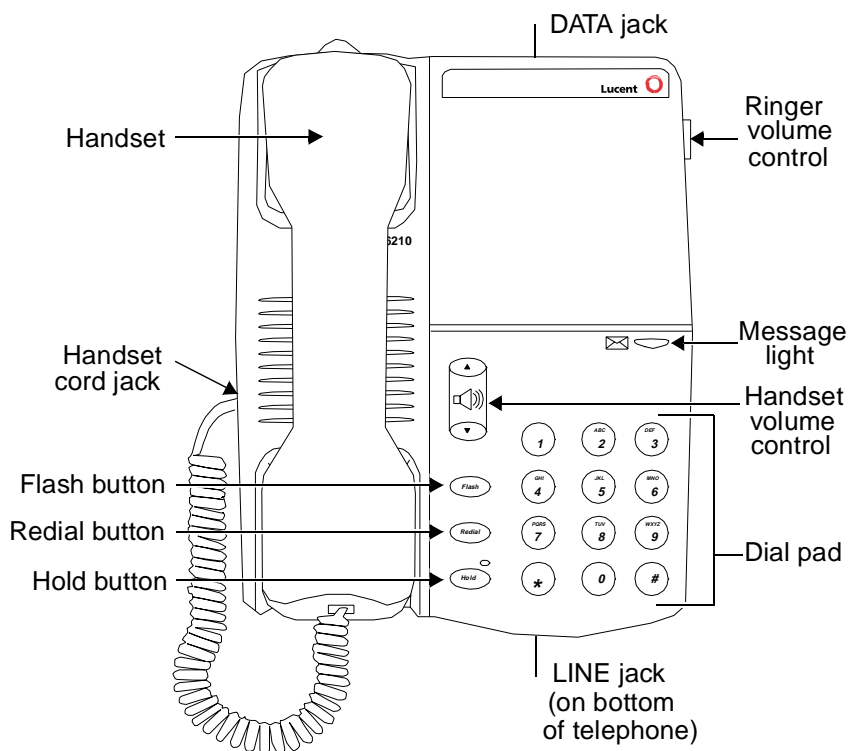

Figure 15-1. The 6210 Telephone

The 6210 telephone is a single-line analog model that requires one tip and ring pair for operation. This telephone has a Ringer volume control on the side of the telephone and a Handset volume control on the front of the set. It uses only Touch-Tone dialing and it also supports the Positive Disconnect function. In addition, this telephone has a Message light, a FLASH button which allows access to system features, a REDIAL button which allows automatic redial, a HOLD button with a single associated light, and a DATA jack on the rear of the telephone.

## Applications

---

The 6210 telephone can be used with the DEFINITY Communications System Generic 1, Generic 2, and Generic 3, the DEFINITY ECS, System 75, and System 85. The telephone has local phone features such as Hold and Redial, and can also be used for the system features with the FLASH button.

## Physical Description

---

### Dimensions



**NOTE:**

The dimensions listed here for the 6210 telephone are approximate.

Width = 6.57 inches (16.69 cm)

Depth (front to back) = 8.8 inches (22.35 cm)

Height (maximum with handset in place) = 3.3 inches (8.38 cm)

### Feature Buttons

#### Fixed Feature Buttons

The 6210 telephone has a FLASH button, which can be used for such features as Conference with business communications systems.

This telephone also has a REDIAL button, which can be used for redialing the last number dialed from the dial pad, either an extension or an outside number. The number redialed can be up to 24 digits.

The 6210 also has a HOLD button, which can be used for putting a call on hold.



#### Message Light (only on the 6210 telephone)

The red Message light on the 6210 telephone flashes when a message is left for the user. It goes off when the user retrieves the message. The Message light also serves as a visual ringing indicator by flashing quickly while the telephone is ringing.

### Other Physical Features

#### Ringing

The 6210 telephone has electronic tone ringing. The ringer volume control is a 3-position switch on the right side of the housing. The volume control is labeled .

The user can also select one of two different ringing patterns. The two ringing pattern settings are labeled   (choose one or the other) and located on the rear of the telephone.

### Touch-Tone Dialing

The 6210 telephone has *only* Touch-Tone Dialing. No special setting is needed to engage this feature.

### Timed Disconnect

The 6210 supports the Timed Disconnect feature. No special setting is needed to engage this feature.

### Mounting Options

This telephone comes equipped with a non-adjustable desk stand which can be turned upside-down and used for wall mounting the telephone.

### Jacks

The 6210 telephone has a Line jack (labeled LINE) on the back of the telephone for connecting a line cord, and a Handset cord jack (labeled ) for connecting the handset.

This telephone also has a Data jack (labeled ) for connecting a device such as a modem to the telephone.

### Handset

The 6210 telephone is equipped with a K-type handset.

### Dial pad

The 6210 telephone is equipped with a 12-button touch-tone dial pad. The letters “Q” and “Z” have been added to the appropriate dial pad keys for directory access, and the “5” button on the dial pad has raised bars for visually-impaired users.

### Cords

Two cords are supplied with the 6210 telephone: a coiled 9-foot modular handset cord and a 7-foot modular line cord.

### Color Options

The 6210 telephone is available in black and in white.



## Distance Limitations

The maximum allowable distances of a 6210 telephone from the DEFINITY G1, G2, and G3, DEFINITY ECS, System 75, or System 85 cabinet are shown in the table below.

Table 15-1. Distance Limitations for the 6210 Telephone

System	Port Board	Nominal Maximum Range in Feet (Meters)		
		22 AWG	24 AWG	26 AWG
DEFINITY G2 and System 85	SN228	12,000 (3,660)	8,000 (2,440)	5,000 (1,525)
	SN228B			
	SN229			
DEFINITY G1 and G3, DEFINITY ECS, and System 75	TN746B	19,000 (5,795)	12,000 (3,660)	7,500 (2,287)
	TN742	3,900 (1,189)	2,500 (762)	1,500 (457)
	TN769			
	TN746			

## Power Requirements

The 6210 telephone receives power from the system and does not require any external power supply.

## Switch Administration

The 6210 telephone must be administered in the following ways:

- If the 6210 telephone is connected to a System 75, a DEFINITY G1 or G3, or a DEFINITY ECS, it must be administered as a 2500 analog telephone *with Message Waiting*.
- If the 6210 telephone is connected to a System 85 or a DEFINITY G2, it can be administered as an analog line.

## Power Failure Operation

The 6210 telephone can be used as an emergency station during power failure transfer conditions.

**15** The 6200 Series Telephones  
*The 6210 Telephone*

15-6

## Ringer Equivalency Numbers

The Ringer Equivalency Number for the 6210 is: AC REN 0.7A, 1.6B

## FCC Registration

The 6210 telephone is FCC registered. The Registration Number of the 6210 is: AS5CHN-25251-MT-E.

## Hearing Aid Compatible

This telephone is compatible with the inductively coupled hearing aids approved by the FCC.

## 6210 Telephone PECs and Comcodes

The 6210 telephone and optional components can be ordered with the following PECs and Comcodes:

- **The 6210 (6210A01A) Telephone**  
PEC: White=3198-10W; Gray=3198-10G  
Comcode: White=108099219; Gray=108099235
- **Handset**  
Comcode: White=108216185; Gray=108216193
- **Handset cord (9 feet)**  
Comcode: White=407632835; Gray=407632850
- **Line cord (7 feet)**  
Comcode: 105642980
- **Line cord (14 feet, silver)**  
PEC: 2725-07N (COL18)  
Comcode: 103786802
- **Line cord (25 feet, silver)**  
PEC: 2725-07S (COL18)  
Comcode: 103786828
- **Desk/Wall Mount base**  
Comcode: White=848020079; Gray=848020087

## Adjuncts

The 6210 telephone does not have an Adjunct equipment jack and therefore will not support any adjuncts.

**15** The 6200 Series Telephones  
    *The 6210 Telephone*

15-7

## **Additional Documents**

---

The following documents contain additional information relating to the 6210 telephone: (Use the 9-digit number listed after each document to order the book from the BCS Publications Center for Lucent Technologies.)

*DEFINITY® Enterprise Communications Server (ECS) Release 6 6210 and 6220 Telephones User's Guide, 555-230-712*

The following instructions are shipped with the individual telephones:

- *6210 Telephone Quick Reference, 555-230-709*

## The 6218 and 6220 Telephones

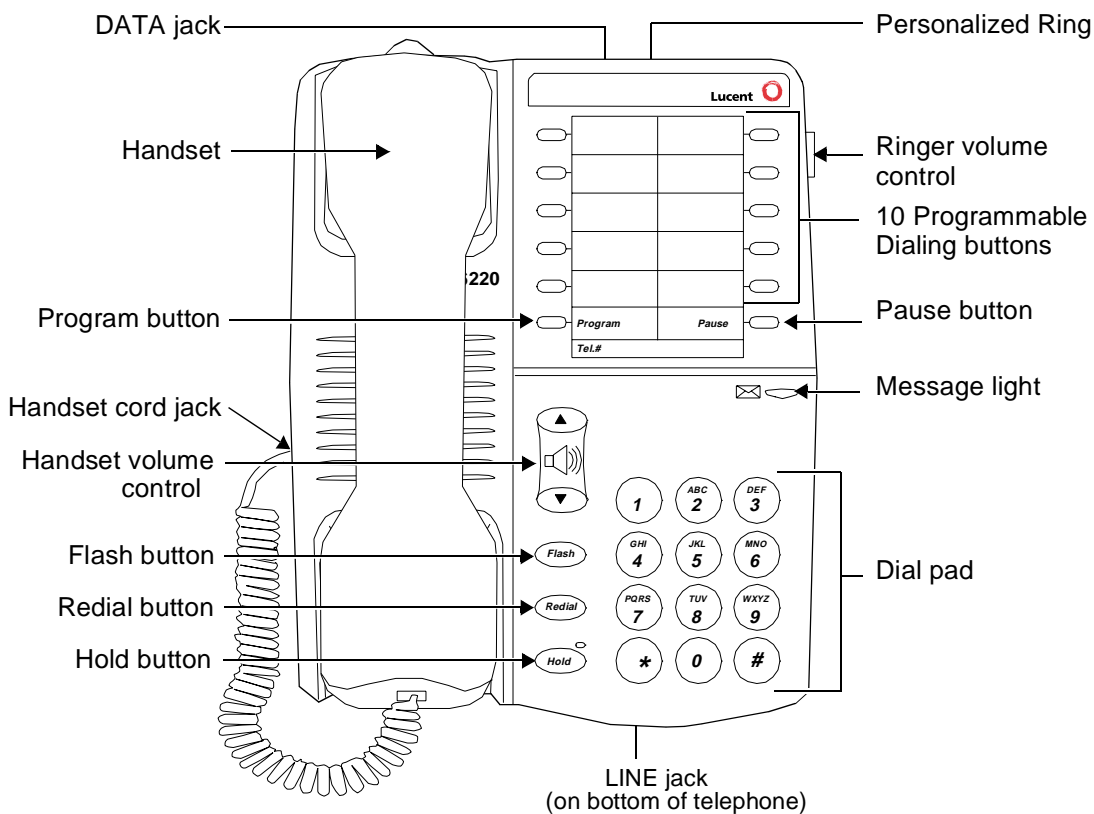

Figure 15-2. The 6218 Telephone

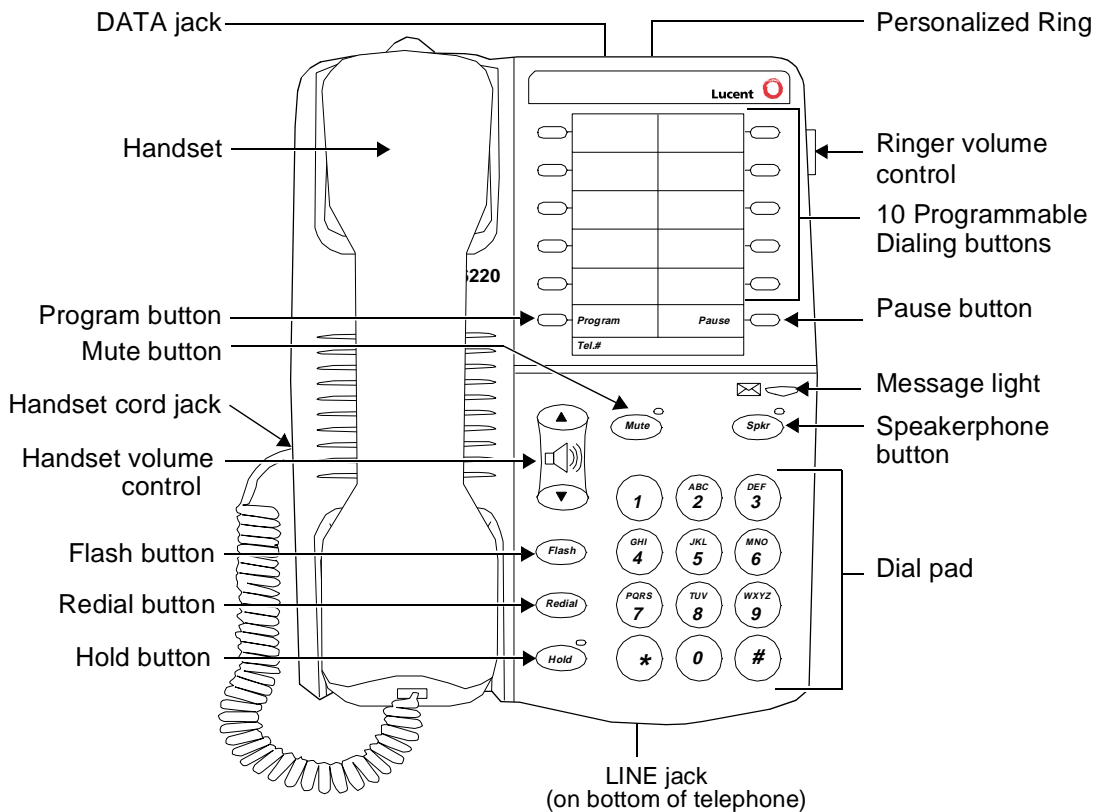

Figure 15-3. The 6220 Telephone

Both the 6218 and the 6220 telephone are single-line analog sets that requires one tip and ring pair for operation. These telephones have 10 programmable dialing buttons, a REDIAL button which allows automatic redial, selected personalized ringing pattern, a Message light, a HOLD button, and a Data jack. The 6220 telephone (only) has a built-in speakerphone (accessed with the SPEAKER button) with Mute capability (the MUTE button). Both telephones allow access to system features with the FLASH button and appropriate dial codes.

## Applications

The 6218 and 6220 telephones can be used with the DEFINITY Communications System Generic 1, Generic 2, and Generic 3, the DEFINITY ECS, System 75, and System 85. These telephones have local phone features, but can also be used with the FLASH button for system features.

## Physical Description

---

### Dimensions



**NOTE:**

The dimensions listed here for the 6218 and 6220 telephones are approximate.

Width = 6.57 inches (16.69 cm)

Depth (front to back) = 8.8 inches (22.35 cm)

Height (maximum with handset in place) = 3.3 inches (8.38 cm)

### Feature Buttons

#### Fixed Feature Buttons

Both the 6218 and the 6220 telephones have the following fixed feature buttons:

- **FLASH button**  
For using features such as Conference with business communications systems.
- **REDIAL button**  
Can be used for redialing the last number dialed from the dial pad, either an extension or an outside number. The number redialed can be up to 24 elements.
- **HOLD button**  
Used for putting a call on hold.
- **Message Light**  
The red Message light flashes when a message is left for the user. It goes off when the user retrieves the message. The Message light also serves as a visual ringing indicator by flashing quickly while the telephone is ringing.
- **Programmable Dialing Buttons**  
These two telephones provide 10 programmable dialing buttons on which the user can store frequently dialed telephone numbers or feature codes. To use these preprogrammed features, the user merely lifts the handset or turns on the speakerphone and then presses the appropriate programmable dialing button.

- PROGRAM and PAUSE buttons

The PROGRAM button is used for storing numbers on the programmable dialing buttons on the upper half of the faceplate of the telephone. The PAUSE button can be used to insert a one half second pause/delay into a telephone number stored on a programmable dialing button.

In addition, the 6220 telephone has the following two features:

- SPEAKERPHONE button

For accessing the built-in speakerphone and microphone combination.



- MUTE button

Turns off the microphone associated with either the speakerphone or the handset, whichever is active.



## Other Physical Features

### Ringing

The 6218 and 6220 telephones have electronic tone ringing. The ringer volume control is a 3-position switch on the right side of the housing. The volume control is labeled .

The user can also select one of two different ringing patterns. The two ringing pattern settings are labeled   (choose one or the other) and located on the rear of the telephone.



### Handset and Speakerphone volume control

The volume control (labeled ) is used for raising or lowering the volume of the handset when the handset is being used, or for raising or lowering the volume of the speakerphone when the speakerphone is active. To raise the volume level, press the upper half of the button labeled ; to lower the volume, press the lower half of the button labeled .

### Mounting Options

The 6218 and 6220 telephones come equipped with a non-adjustable desk stand which can be turned upside-down and used for wall mounting the telephone.

### Jacks

The 6218 and 6220 telephones have a Line jack (labeled LINE) on the back of the telephone for connecting a line cord, and a Handset cord jack (labeled ) on the side of the telephone for connecting the handset. The telephone also has a Data jack (labeled ) on the rear of the set for connecting a device such as a modem to the telephone.

### Handset

The 6218 and 6220 telephones are equipped with a K-type handset.

## Dial pad

The 6218 and 6220 telephones are equipped with a 12-button touch-tone dial pad. The letters "Q" and "Z" have been added to the appropriate dial pad keys for directory access, and the "5" button on the dial pad has raised bars for visually-impaired users.

## Cords

Two cords are supplied with the 6218 and 6220 telephone: a coiled 9-foot modular handset cord and a 7-foot modular line cord.

## Color Options

The 6218 and 6220 telephones are available in black and in white.

## Distance Limitations

The maximum allowable distances of a 6218 and 6220 telephone from the DEFINITY G1, G2, and G3, DEFINITY ECS, System 75, or System 85 cabinet are shown in the table below.

**Table 15-2. Distance Limitations for the 6218 and 6220 Telephones**

System	Port Board	Nominal Maximum Range in Feet (Meters)		
		22 AWG	24 AWG	26 AWG
DEFINITY G2 and System 85	SN228			
	SN228B	12,000 (3,660)	8,000 (2,440)	5,000 (1,525)
	SN229			
DEFINITY G1 and G3, DEFINITY ECS, and System 75	TN746B	19,000 (5,795)	12,000 (3,660)	7,500 (2,287)
	TN742	3,900 (1,189)	2,500 (762)	1,500 (457)
	TN769			
	TN746			

## Power Requirements

The 6218 and 6220 telephones receive power from the system and do not require any external power supply.



## Switch Administration

---

The 6218 and 6220 telephones must be administered in the following ways:

- If the telephone is connected to a System 75, DEFINITY G1 or G3, or a DEFINITY ECS, it must be administered as a 2500 analog telephone with Message Waiting.
- If the telephone is connected to a System 85 or DEFINITY G2, it can be administered as an analog line.



### NOTE:

The programmable dialing buttons are programmed individually on the telephone; they are *not* administrable from the switch.

## Power Failure Operation

---

The 6218 and 6220 telephones can be used as an emergency station during power failure transfer conditions.

## Ringer Equivalency Numbers

---

The Ringer Equivalency Number for the 6218 and 6220 telephones is: 0.5A, 1.5B.

## FCC Registration

---

The 6218 and 6220 telephone are FCC registered (AS5CHN-25383-MT-T).

## Hearing Aid Compatible

---

These telephones are compatible with the inductively coupled hearing aids approved by the FCC.

## 6218 and 6220 Telephones PECs and Comcodes

---

The 6218 and 6220 telephones and optional components can be ordered with the following PECs and Comcodes:

- **The 6218 (6218A01A) Telephone**  
Deep Gray, with English standard-labeled buttons  
PEC: 3198-18G; Comcode: 108459868  
White, with English standard-labeled buttons)  
PEC: 3198-18W; CC#108459850
- **The 6220 (6220A01A) Telephone**  
PEC: White=3198-20W; Gray=3198-20G  
Comcode: White=108099250; Gray=108099268

15 The 6200 Series Telephones

*The 6218 and 6220 Telephones*

15-14

- **Handset**  
Comcode: White=108216185; Gray=108216193
- **Handset cord (9 feet)**  
Comcode: White=407632835; Gray=407632850
- **Line cord (7 feet)**  
Comcode: 105642980
- **Line cord (14 feet, silver)**  
PEC: 2725-07N (COL18)  
Comcode: 103786802
- **Line cord (25 feet, silver)**  
PEC: 2725-07S (COL18)  
Comcode: 103786828
- **Programmable Dialing Button designation cards**  
Single sheet  
Comcode: 848033932  
  
The details of multiple-card packages have not yet been designated.
- **Designation card covers**  
Single card cover  
Comcode: 848033940  
  
The details of multiple-card cover packages have not yet been designated.
- **Desk/Wall Mount base**  
Comcode: White=848020079; Gray=848020087

## Adjuncts

---

The 6218 and 6220 telephones do not have an Adjunct equipment jack and therefore will not support any adjuncts.

## Additional Documents

---

The following documents contain additional information relating to the 6218 and 6220 telephones: (Use the 9-digit number listed after each document to order the book from the BCS Publications Center for Lucent Technologies.)

- *DEFINITY<sup>®</sup> Enterprise Communications Server (ECS) Release 6 6210 and 6220 Telephones User's Guide, 555-230-712*

The following instructions are shipped with every 6218 and 6220 telephone:

- *6218 and 6220 Telephones Quick Reference, 555-230-713*

## The 8100 Series Telephones

# 16

---

The following 8100 Series telephones are described in this section:

- 8101 and the 8101M telephones
- 8102 and the 8102M telephones
- 8110 and the 8110M telephones

## The 8101 and 8101M Telephones

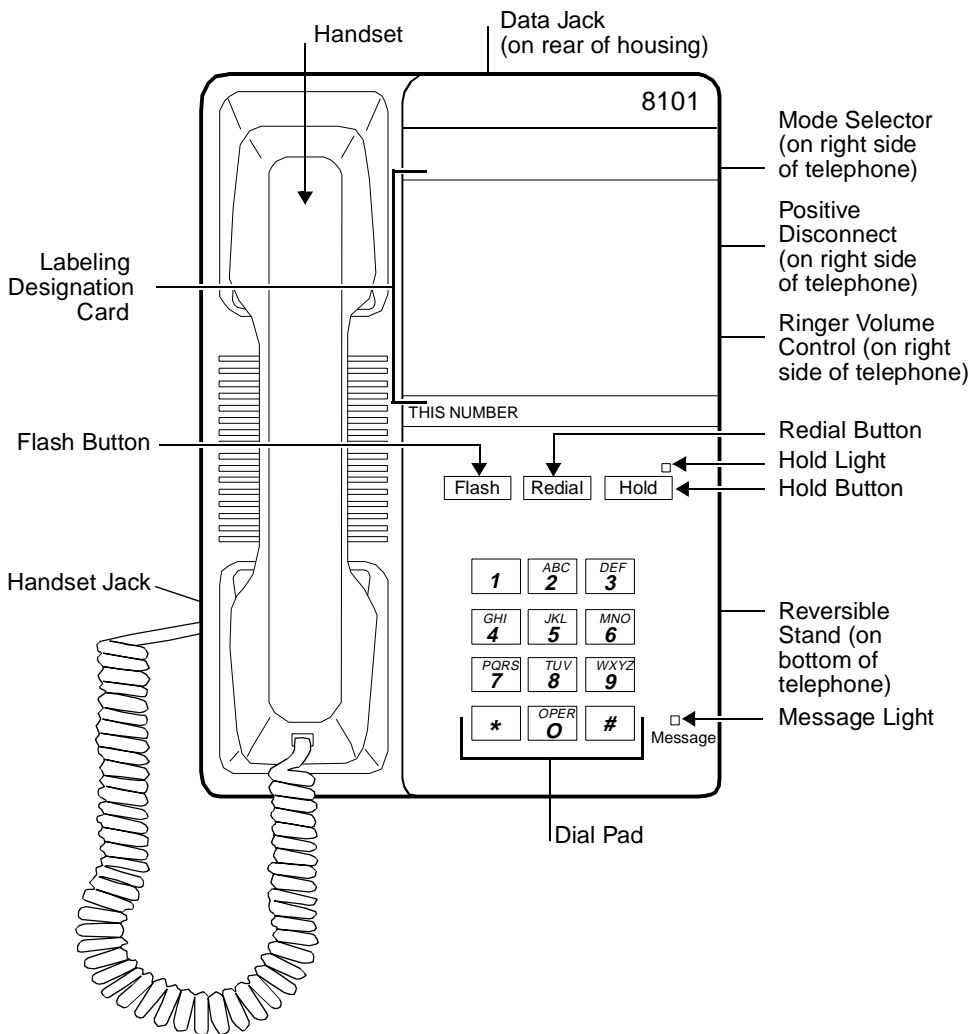

Figure 16-1. The 8101 Telephone

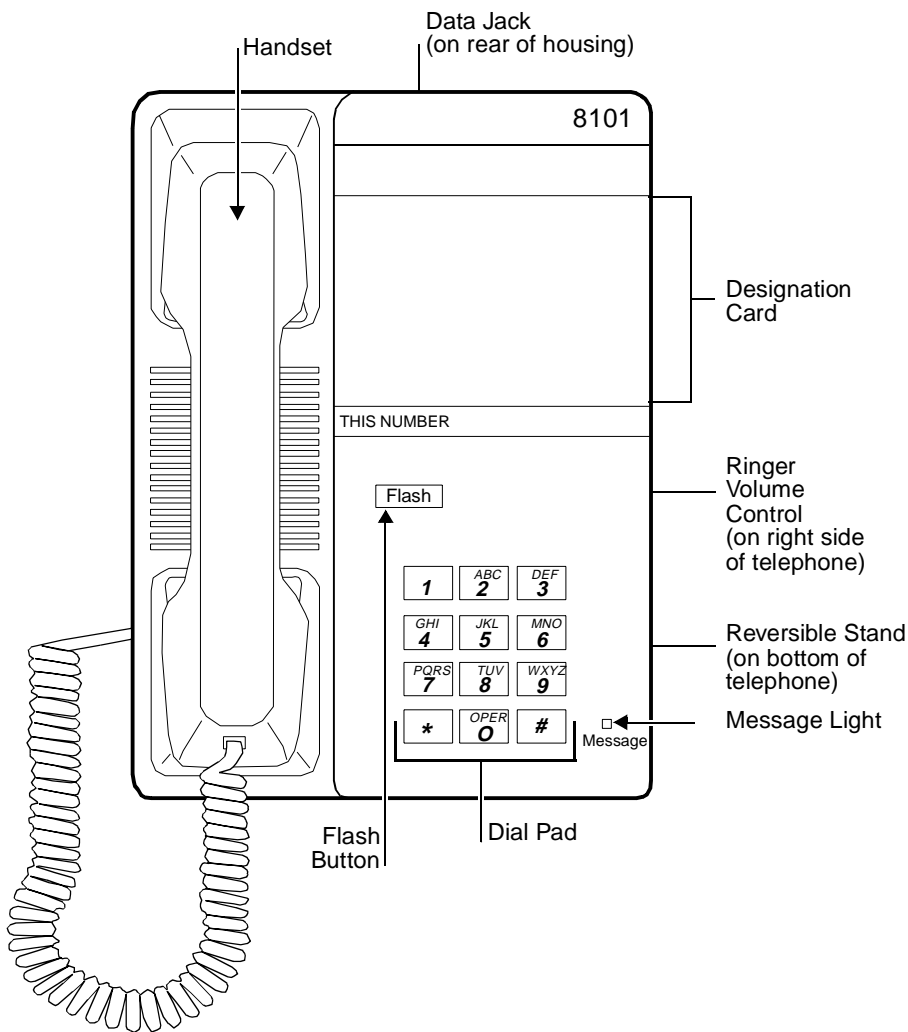

Figure 16-2. The 8101M Telephone

The 8101 and 8101M telephones are single-line analog models that require one tip and ring pair for operation. These telephones contain a Message light, a designation card on which the user can write frequently-dialed numbers and extensions, selectable personalized ringing pattern, and a Data jack. The 8101 and 8101M telephones allow access to system features with the FLASH button and appropriate dial codes. The 8101 telephone provides the added features of automatic redial (with a REDIAL button) and a HOLD button with a single associated light.

## Applications

---

The 8101 and 8101M telephones can be used with the DEFINITY Communications System Generic 1, Generic 2, and Generic 3, the DEFINITY ECS, System 75, and System 85. These telephones have local phone features, but can also be used for the system features with the FLASH button.

## Physical Description

---

### Dimensions



**NOTE:**

The dimensions listed here for the 8101 and 8101M telephones are approximate.

Width = 6-3/4 inches

Depth (front to back) = 9-1/2 inches

Height (maximum with handset in place) = 3-1/2 inches

Thickness of housing = At the top of the telephone, the thickness measures 1-5/8 inches; at the bottom of the telephone, the thickness measures 1 inch.

### Feature Buttons

#### Fixed Feature Buttons

Both the 8101 and 8101M telephones have a FLASH button, which can be used for such features as Conference with business communications systems.

The 8101 also has a REDIAL button, which can be used for redialing the last number dialed from the dial pad, either an extension or an outside number. The number redialed can be up to 20 digits.

The 8101 also has a HOLD button, which can be used for putting a call on hold. If users want to put a call on hold and place another call, they must use the system Hold feature by using the FLASH button.

#### Message Light

The red Message light flashes when a message is left for the user. It goes off when the user retrieves the message. The Message light also serves as a visual ringing indicator by flashing quickly while the telephone is ringing.

#### Designation Card

On the front of the 8101 and 8101M, there is a designation card on which the user can write frequently-dialed telephone numbers and extensions.

## Other Physical Features

### Ringling

The 8101 and 8101M telephones have electronic tone ringing. The ringer volume control is a 3-position switch on the right side of the housing.

### Positive Disconnect

The 8101 telephone has a switch with which the user can select positive disconnect or turn it off. In the ON position, this switch hangs up the phone for approximately two seconds, even if the switchhook depression is for a shorter duration. This action prevents inadvertent switchhook flashes. To initiate a switchhook flash in this mode, the FLASH button must be pressed. In the OFF position, switchhook functioning is normal.

### Mode Selector

The 8101 telephone has a 2-position switch which allows the user to select either rotary pulse or touch tone dialing.

### Mounting Options

The 8101 and 8101M telephones come equipped with a non-adjustable desk stand which can be turned upside-down and used for wall mounting the telephone.

### Jacks

The 8101 and 8101M telephones have a Line jack on the back of the telephone for connecting a line cord, and a Handset cord jack for connecting the handset. These telephones also have a Data jack for connecting a device such as a modem to the telephone.

### Handset

The 8101 and 8101M telephones are equipped with a K-type handset.

### Dial pad

The 8101 and 8101M telephones are equipped with a 12-button touch-tone dial pad. The letters "Q" and "Z" have been added to the appropriate dial pad keys for directory access, and the "5" button on your dial pad has raised bars for visually-impaired users.

### Cords

Two cords are supplied with the 8101 and 8101M telephones: a coiled 9-foot modular handset cord and a 7-foot modular line cord.

### Color Options

The 8101 and 8101M telephones are available in black and in white.

## Distance Limitations

The maximum allowable distances of an 8101 or 8101M telephone from the DEFINITY G1, G2, and G3, DEFINITY ECS, System 75, or System 85 cabinet are shown in the table below.

**Table 16-1. Distance Limitations for the 8101 and 8101M Telephones**

System	Port Board	Nominal Maximum Range in Feet (Meters)	
		24 AWG	26 AWG
System 85	SN229	6,500 (1,981)	4,100 (1,246)
	SN228B	6,500 (1,981)	4,100 (1,246)
DEFINITY G2	SN229	6,500 (1,981)	4,100 (1,246)
	SN228B	6,500 (1,981)	4,100 (1,246)
	TN742	15,200 (4,633)	10,000 (3,050)
	TN746	3,000 (915)	2,000 (610)
DEFINITY G1 and G3, DEFINITY ECS, and System 75	TN742	15,200 (4,633)	10,000 (3,050)
	TN769	15,200 (4,633)	10,000 (3,050)
	TN746	3,000 (915)	2,000 (610)

## Power Requirements

The 8101 and 8101M telephones receive power from the system and do not require any external power supply.

## Switch Administration

The 8101 and 8101M telephones must be administered in the following ways:

- If the 8101 or 8101M telephone is connected to a System 75, a DEFINITY G1 or G3, or a DEFINITY ECS, it must be administered as a 2500 analog telephone with Message Waiting.
- If the 8101 or 8101M telephone is connected to a System 85 or a DEFINITY G2, it can be administered as an analog line.

## Power Failure Operation

The 8101 and 8101M telephone can be used as an emergency station during power failure transfer conditions.



**16** The 8100 Series Telephones  
*The 8101 and 8101M Telephones*

16-7

## Ringer Equivalency Numbers

The Ringer Equivalency Number for the 8101 and 8101M telephones is:  
REN 0.4A, 0.8B.

## FCC Registration

The 8101 and 8101M telephones are FCC registered (AS5CHN-20714-MT-E).

## Hearing Aid Compatible

These two telephones are compatible with the inductively coupled hearing aids prescribed by the FCC.

## 8101 and 8101M Telephones PECs and Comcodes

The 8101 and 8101M telephones and optional components can be ordered with the following PECs and Comcodes:

- **Basic 8101 Telephone**  
PEC: 3192-101 (Black=COL09; White=COL10)  
Comcode: Black=106272289; White=106272297
- **8101M Telephone**  
PEC (through 1996): 3192-102 (Black=COL09; White=COL10)  
Comcode (through 1996): Black=107358889; White=107358897  
Comcode (starting in 1997): Black=107730491; White=107305509
- **Handset**  
Comcode: Black=107136800; White=106063408
- **Handset cord (9 feet)**  
Comcode: Black=107154262; White: 107154270
- **Line cord (7 feet)**  
Comcode: 107123069
- **Line cord (14 feet, silver)**  
PEC: 2725-07N (COL18)  
Comcode: 103786802
- **Line cord (25 feet, silver)**  
PEC: 2725-07S (COL18)  
Comcode: 103786828

16 The 8100 Series Telephones

*The 8101 and 8101M Telephones*

16-8

- **Designation strips**  
PEC: 31941 (Package of 25)  
Comcode: 847367539  
PEC: 31942 (Package of 100)  
Comcode: 847367547
- **Designation card covers**  
Comcode: 847173937

## Adjuncts

---

The 8101 and 8101M telephones do not have an Adjunct equipment jack and therefore will not support any adjuncts.

## Additional Documents

---

The following documents contain additional information relating to the 8101 and 8101M telephone: (Use the 9-digit number listed after each document to order the book from the BCS Publications Center for Lucent Technologies.)

- *DEFINITY Communications System Generic 1, Generic 2, and Generic 3, System 75 and System 85 8101, 8102, 8102M, 8110, 8110M Telephones User's Guide, 555-230-774*

The following instructions are shipped with every 8101 and 8101M telephone:

- *8101, 8102 and 8110 Telephones User's Manual, 555-015-131*
- *8101, 8101M, 8102M and 8110M Telephones Quick Reference Guide*

## The 8102 and 8102M Telephones

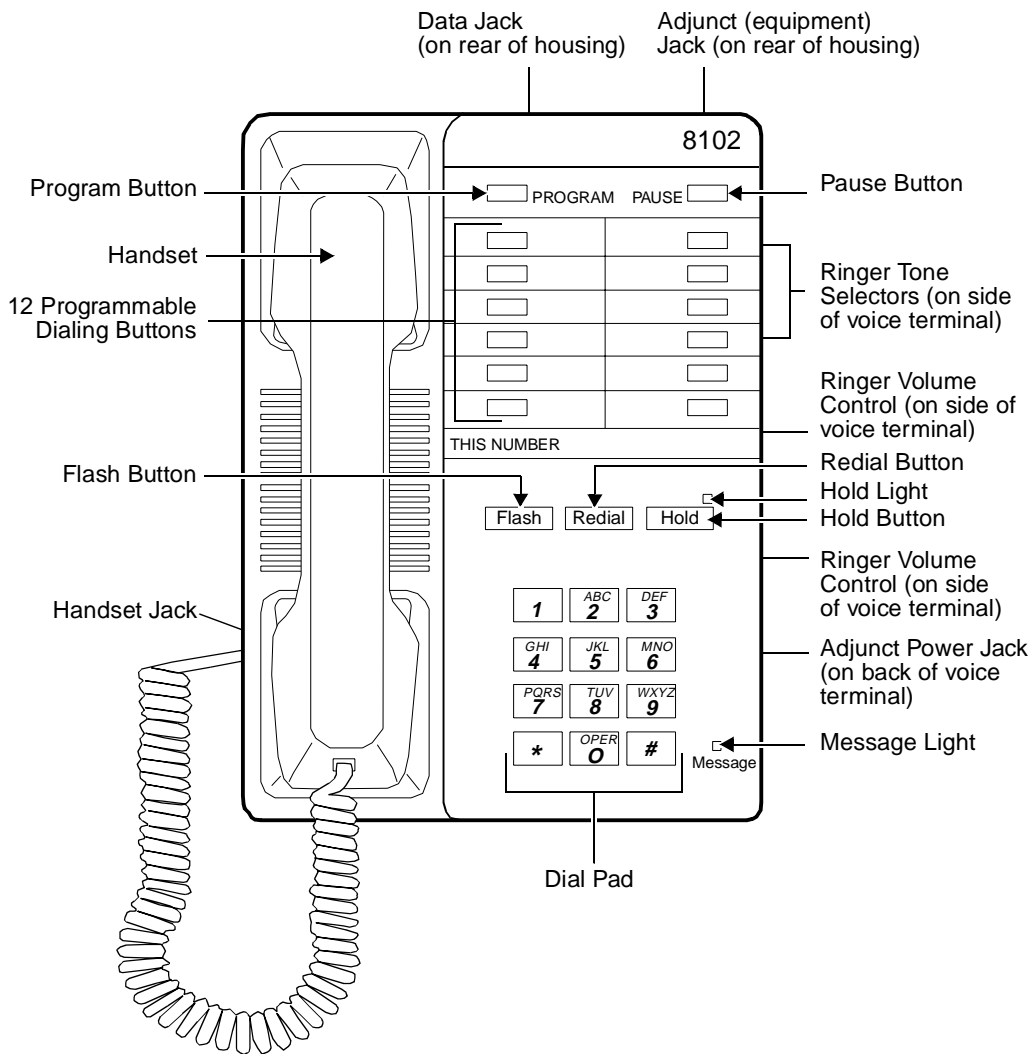

Figure 16-3. The 8102 and 8102M Telephone

The basic 8102 telephone (which includes the 8102A01A and 8102A01B) and the modified 8102M (8102A01C) telephone are single-line analog sets that require one tip and ring pair for operation. These telephones are exactly the same in appearance: each contains 12 programmable dialing buttons, automatic redial (with the REDIAL button), selected personalized ringing pattern, a Message light,

**16** The 8100 Series Telephones  
*The 8102 and 8102M Telephones*

16-10

a HOLD button, a Data jack, and an Adjunct jack. The 8102 and 8102M telephones also allow access to system features with the FLASH button and appropriate dial codes.

 **NOTE:**

In late 1995, the basic 8102 telephone was no longer manufactured. Only the 8102M is available.

## Applications

The 8102 and 8102M telephones can be used with the DEFINITY Communications System Generic 1, Generic 2, and Generic 3, the DEFINITY ECS, System 75, and System 85. These telephones have local phone features, but can also be used with the FLASH button for system features.

The 8102 and 8102M telephones can be converted to a hotel/motel telephone for the lodging industry. The converted telephone has 10 pre-programmed buttons which enable users easy communication with assigned numbers within the hotel/motel, such as the front desk or housekeeping service, for instance.

## Physical Description

### Dimensions

 **NOTE:**

The dimensions listed here for the 8102 and 8102M telephones are approximate.

Width = 6-3/4 inches

Depth (front to back) = 9-1/2 inches

Height (maximum with handset in place) = 3-1/2 inches

Thickness of housing = At the top of the telephone, the thickness measures 1-5/8 inches; at the bottom of the telephone, the thickness measures 1 inch.

### Feature Buttons

#### Fixed Feature Buttons

The 8102 and 8102M telephones have the following fixed feature buttons:

- FLASH button

For using features such as Conference with business communications systems.

- REDIAL button

Can be used for redialing the last number dialed from the dial pad, either an extension or an outside number. The number redialed can be up to 20 digits.

With the (Redial) Auto-Pause feature, the telephone can be programmed to insert pauses after a dial access code (such as 9) in a redialed number. If the user usually waits a short period to obtain a second dial tone after dialing an access code, this waiting time can be set by programming the automatic pause between the system access code and the telephone number. The (Redial) Auto-Pause feature will help eliminate misdialing.

- HOLD button

Used for putting a call on hold. If users want to put a call on hold and place another call, they must use the system Hold feature by using the FLASH button.

- Message Light

The red Message light flashes when a message is left for the user. It goes off when the user retrieves the message. The Message light also serves as a visual ringing indicator by flashing quickly while the telephone is ringing.

- Programmable Dialing Buttons

The 8102 and 8102M telephones provide 12 programmable dialing buttons on which the user can store frequently dialed telephone numbers or feature codes. To use these preprogrammed features, the user merely lifts the handset and then presses the appropriate programmable dialing button.

- PROGRAM and PAUSE buttons

Both of these buttons are used for storing numbers on the preprogrammed dialing buttons on the upper half of the faceplate of the telephone. The PAUSE button can be used to insert a one half second pause/delay into a telephone number stored on a programmable dialing button or into a dialing access code in the Auto-Pause feature of Redial.

## Other Physical Features

### Ringing

The 8102 and 8102M telephones have electronic tone ringing. The ringer volume control is a 3-position switch on the right side of the housing.

The user can also use a Tone Selector (labeled "LO HI") for selecting one of two tone ringer frequencies or a second Tone Selector (labeled "SLOW FAST") for selecting one of two tone ringer modulation rates. Both Tone Selector switches are on the right side of the telephone.

## **Mounting Options**

The 8102 and 8102M telephones come equipped with a non-adjustable desk stand which can be turned upside-down and used for wall mounting the telephone.

## **Jacks**

The 8102 and 8102M telephones have a line jack on the back of the telephone for connecting a line cord, and a Handset cord jack for connecting the handset. These telephones also have a Data jack for connecting a device such as a modem to the telephone.

The 8102 and 8102M telephones have an Adjunct (equipment) jack which allows the connection of a speakerphone to the telephone and an adjunct power jack for connecting an auxiliary power source for using the adjunct equipment.

## **Handset**

The 8102 and 8102M telephones are equipped with a K-type handset.

## **Dial pad**

The 8102 and 8102M telephones have a 12-button touch-tone dial pad. The letters "Q" and "Z" have been added to the appropriate dial pad keys for directory access, and the "5" button on your dial pad has raised bars for visually-impaired users.

## **Cords**

Two cords are supplied with the 8102 and 8102M telephones: a coiled 9-foot modular handset cord and a 7-foot modular line cord.

## **Color Options**

The 8102 and 8102M telephones are available in black and in white.

## Distance Limitations

The maximum allowable distances of an 8102 or 8102M telephone from the DEFINITY G1, G2, and G3, DEFINITY ECS, System 75, or System 85 cabinet are shown in the table below.

**Table 16-2. Distance Limitations for the 8102 and 8102M Telephones**

System	Port Board	Nominal Maximum Range in Feet (Meters)	
		24 AWG	26 AWG
System 85	SN229	6,500 (1,981)	4,100 (1,246)
	SN228B		
DEFINITY G2	SN229	6,500 (1,981)	4,100 (1,246)
	SN228B	6,500 (1,981)	4,100 (1,246)
	TN742	15,200 (4,633)	10,000 (3,050)
	TN746	3,000 (915)	2,000 (610))
DEFINITY G1 and G3, DEFINITY ECS, and System 75	TN742	15,200 (4,633)	10,000 (3,050)
	TN769	15,200 (4,633)	10,000 (3,050)
	TN746	3,000 (915)	2,000 (610)

## Power Requirements

The 8102 and 8102M telephones must have auxiliary power for adjunct equipment when such equipment is connected.

## Switch Administration

The 8102 and 8102M telephones must be administered in the following ways:

- If the 8102 or 8102M telephone is connected to a System 75, DEFINITY G1 or G3, or a DEFINITY ECS, it must be administered as a 2500 analog telephone with Message Waiting
- If the 8102 or 8102M telephone is connected to a System 85 or DEFINITY G2, it can be administered as an analog line.

### NOTE:

The programmable dialing buttons are programmed individually on the telephone; they are *not* administrable from the switch.

## Administration of Hidden Features

For procedures on administering the hidden features on the 8102M (*to be done ONLY by the system administrator*) such as:

- Reprogramming the Hold Feature
- Administering the Timed Disconnect Feature
- Locking the Programmable Dialing Buttons

Refer to the *8101, 8101M, 8102M and 8110M Telephones Quick Reference Guide* which comes in the box with the 8102M.

## Power Failure Operation

The 8102 or 8102M telephone can be used as an emergency station during power failure transfer conditions.

## Ringer Equivalency Numbers

The Ringer Equivalency Number for the 8102 telephone is: 0.5A and 1.6B. For the 8102M the Ringer Equivalency Number is: 1.5B and 0.8A.

## FCC Registration

The 8102 and 8102M telephones are FCC registered (A5SUSA-65132-MT-E).

## Hearing Aid Compatible

These telephones are compatible with the inductively coupled hearing aids prescribed by the FCC.

## 8102 and 8102M Telephones PECs and Comcodes

The 8102 and 8102M telephones and optional components can be ordered with the following PECs and Comcodes:

- **Basic 8102 (8102A01A and 8102A01B) Telephone**  
PEC: 3192-001 (Black=COL09; White=COL10)  
Comcode: Black=106272305; White=106272313
- **Modified 8102M (8102A01C) Telephone**  
PEC: 3192-001 (Black=COL09; White=COL10)  
Comcode: Black=107538357; White=107538365
- **Handset**  
Comcode: Black=106050065; White=106053408



16 The 8100 Series Telephones

The 8102 and 8102M Telephones

16-15

- **Handset cord (9 feet)**  
Comcode: Black=105635429; White=105701809
- **Line cord (7 feet)**  
Comcode: 103732541
- **Line cord (14 feet, silver)**  
PEC: 2725-07N (COL18)  
Comcode: 103786802
- **Line cord (25 feet, silver)**  
PEC: 2725-07S (COL18)  
Comcode: 103786828
- **Button designation card**  
PEC: 31932 (Package of 25)  
PEC: 31938 (Tractor Feed)  
  
Single Sheet  
Comcode: 846562700  
  
25 Sheets  
Comcode: 846562718  
  
Tractor Feed  
Comcode: 846562726
- **Designation card covers**  
PEC: 31937 (package of 25)  
Comcode: 106523236
- **Repertory Dial buttons (Programmable dialing buttons)**  
(These buttons can be used to replace lost buttons or to replace the two buttons removed for hotel/motel conversion.)  
(Package of 80)  
PEC: 31936  
Comcode: 106503238
- **Security designation card and cover**  
(These cards and covers are for concealing the PROGRAM and PAUSE buttons and the two topmost programmable dialing buttons so that unauthorized changes cannot be made to the programmable dialing assignments.)  
(Package of 25 cards and clear plastic designation card covers)  
PEC: 31931  
Comcode: 106248370
- **Stands**  
(These stands can be used to replace damaged or broken stands.)  
(Package of 5)  
PEC: 31933  
Comcode: 106503204

## **Adjuncts**

---

The 8102 and 8102M telephones can be equipped with one of the following adjuncts:

- S101A Speakerphone (not orderable)
- S201A Speakerphone

## **Additional Documents**

---

The following documents contain additional information relating to the 8102 and 8102M telephones: (Use the 9-digit number listed after each document to order the book from the BCS Publications Center for Lucent Technologies.)

- *DEFINITY Communications System Generic 1, Generic 2, and Generic 3, System 75 and System 85 8101, 8102, 8102M, 8110, 8110M Telephones User's Guide*, 555-230-774

The following instructions are shipped with every 8102 telephone:

- *8101, 8102 and 8110 Telephones User's Manual*, 555-015-131

The following instructions are shipped with every 8102M telephone:

- *8101, 8101M, 8102M and 8110M Telephones Quick Reference Guide*

## The 8110 and 8110M Telephones

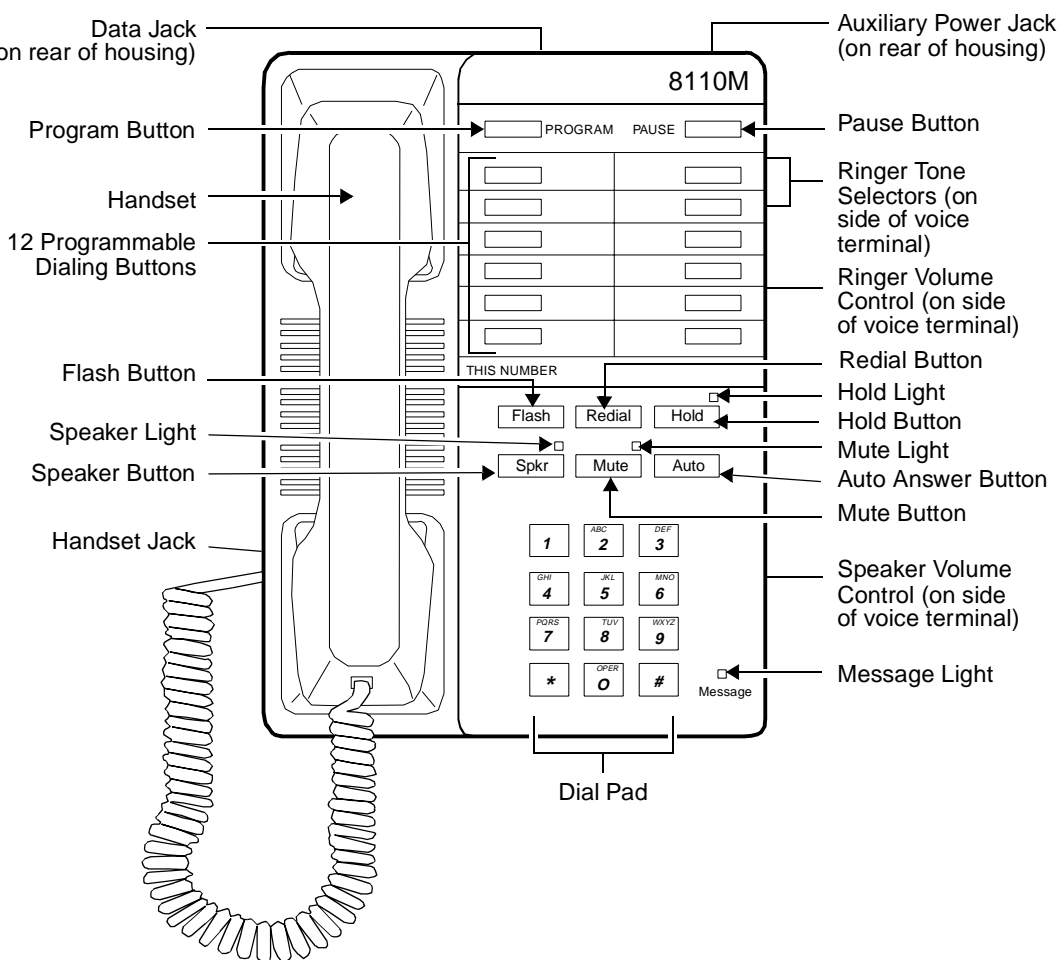

Figure 16-4. The 8110 and 8110M Telephones (The 8110M is shown here)

The basic 8110 (which includes the 8110A01A, 8110A01B, and 8110A01C) and the modified 8110M (8110A01D) telephones are single-line analog sets that require one tip and ring pair for operation. These telephones are exactly the same in appearance: each contains 12 programmable dialing buttons with a PROGRAM and PAUSE button for programming, automatic redial, selected personalized ringing pattern, a flashing red Message light, and a HOLD button. They also have a built-in speakerphone with Mute capability and the Automatic Answer (and disconnect) feature. The 8110 and 8110M telephones also allow access to system features via the FLASH button and appropriate dial codes.



**NOTE:**

In late 1995, the basic 8110 was no longer manufactured. Only the 8110M is available.

## Applications

---

The 8110 and 8110M telephones can be used with the DEFINITY Communications System Generic 1, Generic 2, and Generic 3, the DEFINITY ECS, System 75, and System 85. These telephones have local phone features, but can also be used for system features via the Flash button.

With the D-182363 Kit of Parts, the 8110 and 8110M telephones can be converted to a hotel/motel telephone for the lodging industry. The converted telephone has 10 preprogrammed buttons (with the PROGRAM and PAUSE buttons and two uppermost programmable dialing buttons concealed). The programmable dialing buttons enable users easy communication with assigned numbers within the hotel/motel, such as the front desk or housekeeping service. These telephones can also be used in any unsecured location where hiding the Program and Pause buttons is desirable.

## Physical Description

---

### Dimensions



**NOTE:**

The dimensions listed here for the 8110 and 8110M telephones are approximate.

Width = 6-3/4 inches

Depth (front to back) = 9-1/2 inches

Height (maximum with handset in place) = 3-1/2 inches

Thickness of housing = At the top of the telephone, the thickness measures 1-5/8 inches; at the bottom of the telephone, the thickness measures 1 inch.

### Features

#### Fixed Feature Buttons

The 8110 and 8110M telephones have the following fixed feature buttons:

- FLASH button

For using features such as Transfer or Conference with business communications systems.

- REDIAL button

Can be used for redialing the last number dialed from the dial pad, either an extension or an outside number. The number redialed can be up to 20 digits.

With the (Redial) Auto-Pause feature, the telephones can be programmed to insert pauses after a dial access code (such as 9) in a redialed number. If the user usually waits a short period to obtain a second dial tone after dialing an access code, this waiting time can be set by programming the automatic pause between the system access code and the telephone number. The (Redial) Auto-Pause feature will help eliminate misdialing.

- HOLD button

Used for putting a call on hold. If users want to put a call on hold and place another call, they must access the system Hold feature by using the Flash button.

- Speakerphone button (labeled SPKR)

Used for 2-way conversation with another party without lifting the handset.

Speaker volume is controlled by using the Speaker volume control switch on the right side of the telephone.

- MUTE button

Used for turning off the microphone of the built-in speakerphone or the handset.

- Auto Answer button (labeled AUTO)

Used for enabling calls to be automatically answered a call without lifting the handset. For those who require speakerphone functionality without use of the Auto-Answer feature, the Auto-Answer button can be removed and replaced with a flat cap cover shipped with each 8110 and 8110M telephone.

## Message Light

The red Message light flashes when a message is left for the user. It goes off when the user retrieves the message. The Message light also serves as a visual ringing indicator by flashing quickly while the telephone is ringing.

## Programmable Dialing Buttons

The 8110 and 8110M telephones provide 12 programmable dialing buttons on which the user can store frequently dialed telephone numbers or feature codes. Twenty elements can be stored on one button (digits and characters, such as a # or \* or Pause or Flash). To use these pre-programmed features, the user merely lifts the handset (the user may choose, instead, to press the SPEAKER button to turn on the speakerphone) and then press the appropriate programmable dialing button.

## **PROGRAM and PAUSE buttons**

Both of these buttons are used for storing numbers on the pre-programmed dialing buttons on the upper half of the faceplate of the telephone. The PAUSE button can be used to insert one or more one half-second pause/delay into a telephone number stored on a programmable dialing button or into a dialing access code in the (Redial) Auto-Pause feature.

## **Other Physical Features**

### **Ringing**

The 8110 and 8110M telephones have electronic tone ringing. The ringer volume control is a 3-position switch on the right side of the housing.

The user can also use a Tone Selector (labeled "LO HI") for selecting one of two tone ringer frequencies and a second Tone Selector (labeled "SLOW FAST") for selecting one of two tone ringer modulation rates. Both Tone Selector switches are on the right side of the telephone.

### **Mounting Options**

The 8110 and 8110M telephones come equipped with a desk stand which can be turned upside-down and used for wall mounting the telephone.

### **Jacks**

The 8110 and 8110M telephones have a Line jack on the back of the telephone for connecting a line cord, and a Handset cord jack for connecting the handset. These telephones also have a Data jack on the rear of the telephone for connecting a device such as a modem or a personal FAX to the telephone.

### **⇒ NOTE:**

The 8110 and 8110M telephones have no connector for the S201A Speakerphone or 500A Headset Adapter.

The 8110 and 8110M telephones also have an auxiliary power jack which can be used for improving the performance of the built-in speakerphone on long loops where there is limited power available from the line. In certain circumstances, other than extended loop lengths, it may also be necessary to use adjunct power.

### **Handset**

The 8110 and 8110M telephones are equipped with a K-type handset. A K-type amplified handset can also be used with these telephones.

### **Dial pad**

The 8110 and 8110M telephones are equipped with a 12-button touch-tone dial pad. The letters "Q" and "Z" have been added to the appropriate dial pad keys for directory access, and the "5" button on the dial pad has raised bars for visually-impaired users.

**Cords**

Two cords are supplied with the 8110 and 8110M telephones: a coiled 9-foot modular handset cord and a 7-foot modular line cord.

**Color Options**

The 8110 and 8110M telephones are available in black and in white.

**Distance Limitations**

---

The maximum allowable distances of an 8110 or 8110M telephone from the DEFINITY G1, G2, and G3, a DEFINITY ECS, System 75, or System 85 cabinet are shown in the table below.

**Table 16-3. Distance Limitations for the 8110 and 8110M Telephones**

System	Port Board	Nominal Maximum Range in Feet (Meters)		
		22 AWG	24 AWG	26 AWG
DEFINITY G2 and System 85	SN228	12,000 (3,660)	8,000 (2,440)	5,000 (1,525)
	SN228B			
	SN229			
DEFINITY G1 and G3, DEFINITY ECS, and System 75	TN746B	19,000 (5,795)	12,000 (3,660)	7,500 (2,287)
	TN742	3,900 (1,189)	2,500 (762)	1,500 (457)
	TN769			
	TN746*			

---

\* Auxiliary power is necessary at all operating distances.

---

## Power Requirements

It is recommended that the 8110 and 8110M telephones have auxiliary power (9V DC, 100 mA) to improve the performance of the speakerphone under the following conditions: (See the table below.)



**NOTE:**

Use with the TN746 circuit pack requires auxiliary power (in the form of a power adapter) at all loop lengths. On System 85 and DEFINITY G2, the line must be administered as Data Restricted to allow for the automatic disconnect feature.

**Table 16-4. Power Requirements for the 8110 and 8110M Telephones**

Circuit Pack	Loop Information
If you are using: Circuit Pack TN742 Circuit Pack TN769	<ul style="list-style-type: none"> <li>■ When loop length exceeds:                             <ul style="list-style-type: none"> <li>— 16,000 feet (22 gauge)</li> <li>— 10,000 feet (24 gauge)</li> <li>— 6,300 feet (26 gauge)</li> </ul> </li> <li>or</li> <li>■ When loop resistance exceeds 256 ohms</li> <li>or</li> <li>■ When loop current is less than 26 mA</li> </ul>
If you are using: Circuit Pack SN229	<ul style="list-style-type: none"> <li>■ When loop length exceeds:                             <ul style="list-style-type: none"> <li>— 11,000 feet (22 gauge)</li> <li>— 7,000 feet (24 gauge)</li> <li>— 4,400 feet (26 gauge)</li> </ul> </li> <li>or</li> <li>■ When loop resistance exceeds 180 ohms</li> <li>or</li> <li>When loop current is less than 26 mA</li> </ul>
Any installation	When loop current is less than 26 mA
Any installation	When another analog telephone is bridged with the 8110 or 8110M telephone



## Switch Administration

---

The 8110 and 8110M telephones must be administered in the following ways:

- If the 8110 or 8110M telephone is connected to a System 75, DEFINITY G1 or G3, or a DEFINITY ECS, it must be administered as a 2500 analog telephone with Message Waiting.
- If the 8110 or 8110M telephone is connected to a System 85 or DEFINITY G2, it can be administered as an analog line.



### NOTE:

The programmable dialing buttons are programmed individually on the telephone; they are *not* administrable from the switch.

## Administration of Hidden Features

---

For procedures on administering the hidden features on the 8110M (*to be done ONLY by the system administrator*) such as:

- Reprogramming the Hold Feature
- Administering the Timed Disconnect Feature
- Locking the Programmable Dialing Buttons

Refer to the 8101, 8101M, 8102M and 8110M Telephones Quick Reference Guide which comes in the box with the 8110M.

## Power Failure Operation

---

The 8110 or 8110M telephone can be used as an emergency station during power failure transfer conditions. If the telephone is over 3,000 feet from the cabinet, the telephone will not work properly.

## Ringer Equivalency Numbers

---

The Ringer Equivalency Number for the 8110 telephone is: 0.5A and 1.6B. For the 8110M telephone the Ringer Equivalency Number is: 0.6A and 1.6B.

## FCC Registration

---

The 8110 and 8110M telephones are FCC registered (A5SUSA-18602-MT-E).

## Hearing Aid Compatible

---

These telephones are compatible with the inductively coupled hearing aids prescribed by the FCC.

## 8110 and 8110M Telephones Equipment PECs and Comcodes

---

The 8110 and 8110M telephones and components can be ordered with the following PECs and Comcodes:

- **Basic 8110 (8110A01A, 8110A01B, and 8110A01C) Telephone**  
PEC: 3193-001 (Black=COL09; White=COL10)  
Comcode: Black=106272321; White=106272339
- **Modified 8110M (8110A01D) Telephone**  
PEC: 3193-001 (Black=COL09; White=COL10)  
Comcode: Black=107535841; White=107535858
- **Handset**  
Comcode: Black=106050065; White=106053408
- **Handset cord**  
Comcode: Black=105635429; White=105701809
- **Line cord (7 feet)**  
Comcode: 103732541
- **Line cord (14 feet, silver)**  
PEC: 2725-07N (COL18)  
Comcode: 103786802
- **Line cord (25 feet, silver)**  
PEC: 2725-07S (COL18)  
Comcode: 103786828
- **Button designation card**  
PEC: 31932 (Package of 25)  
PEC: 31938 (Tractor Feed)  
Single Sheet Comcode: 846562700  
25 Sheets Comcode: 846562718  
Tractor Feed Comcode: 846562726
- **Designation card covers**  
PEC: 31937  
Comcode: 106523236
- **Repertory Dial buttons (Programmable dialing buttons)**  
(These buttons can be used to replace lost buttons or to replace the two buttons removed for hotel/motel conversion.)  
(Package of 80)  
PEC: 31936  
Comcode: 106503238

- **Security designation card and cover**  
(These cards and covers are for concealing the PROGRAM and PAUSE buttons and the two topmost programmable dialing buttons so that unauthorized changes cannot be made to the programmable dialing assignments.) (Package of 25 cards and clear plastic designation card covers)  
PEC: 31931  
Comcode: 106248370
- **Stands**  
(These stands can be used to replace damaged or broken stands.)  
(Package of 5)  
PEC: 31933  
Comcode: 106503204
- **Speakerphone power adapter**  
(This local power is necessary when reaching limitations for loop length or when using the TN746 circuit pack.)  
PEC: 31930  
Comcode: 106460470
- **Auto-Answer buttons**  
(These buttons can be used to replace lost buttons or to restore the Auto-Answer feature if it has been deactivated.)  
(Package of 25)  
PEC: 31935  
Comcode: 106503212
- **Auto Answer flat caps**  
(These caps are designed to cover the Auto-Answer button opening when the Auto-Answer button has been removed.)  
(Package of 25)  
PEC: 31934  
Comcode: 106503220

## Adjuncts

---

A **K-type Noisy Environment Handset** (PEC: 31052A) can also be purchased and connected to the 8110 or 8110M telephone.



**NOTE:**

Neither the 8110 nor the 8110M telephone has a connector for the S201A or S203 Speakerphone or the 500A Headset Adapter.

16 The 8100 Series Telephones  
*The 8110 and 8110M Telephones*

16-26

## Additional Documents

---

The following documents contain additional information relating to the 8110 and 8110M telephones: (Use the 9-digit number listed after each document to order the book from the BCS Publications Center.)

- *DEFINITY Communications System Generic 1, Generic 3, and System 75, DEFINITY Generic 2 and System 85 8101, 8102, 8102M, 8110, 8110M Telephones User's Guide, 555-230-774*

The following instructions are shipped with every 8110 telephone:

- *8101, 8102, and 8110 Telephones User's Manual, 555-015-131*

The following instructions are shipped with every 8110M telephone:

- *8101, 8101M, 8102M and 8110M Telephones Quick Reference Guide*

## ISDN Voice Terminals

# 17

---

The following voice terminals described in this section are used with the Integrated Services Digital Network (ISDN) communication system:

- ISDN 7505 modular voice terminal
- ISDN 7506 display terminal
- ISDN 7507 display terminal
- ISDN 8503T voice terminal
- ISDN 8510T voice/data terminal
- ISDN 8520T voice/data terminal

## The ISDN 7505 Modular Terminal

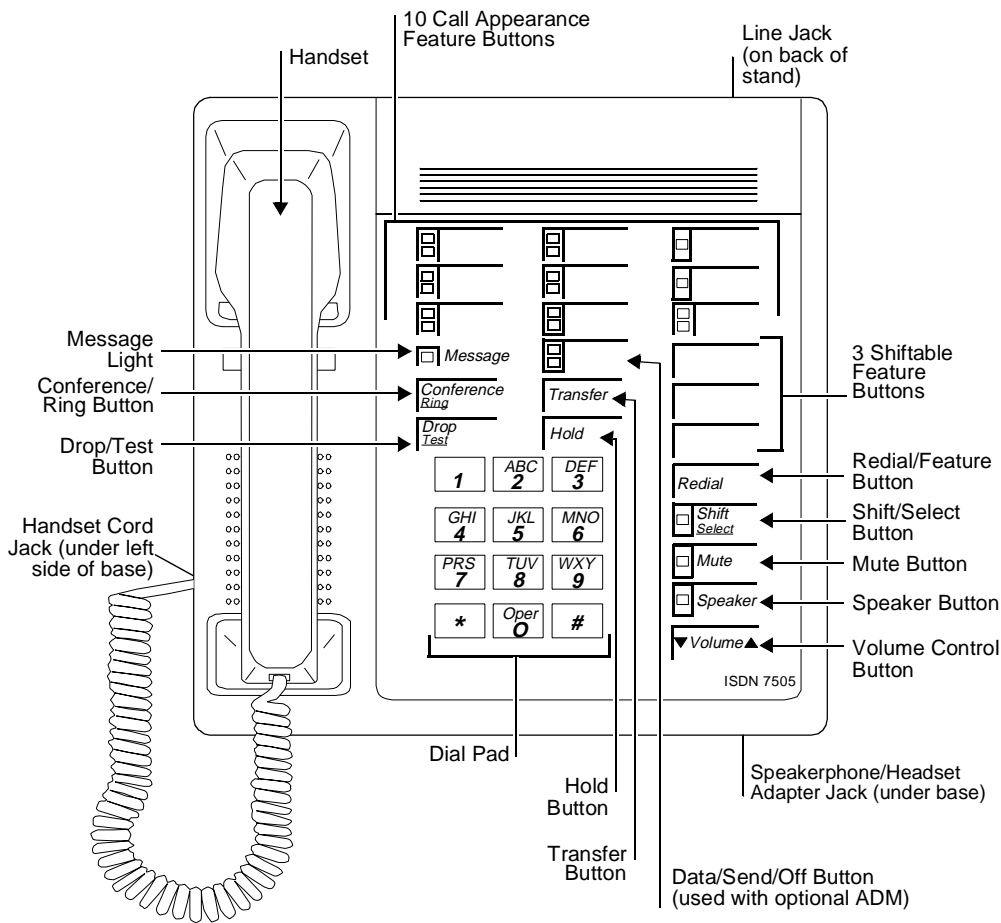

Figure 17-1. The 7505 Asynchronous Data Modular Terminal

17 ISDN Voice Terminals

*The ISDN 7505 Modular Terminal*

17-3

The 7505 Modular Terminal is used with the Integrated Services Digital Network (ISDN) communication system through a 4-wire "T"-interface. The modular 7505 is a voice terminal when equipped with a Voice Only Module (VOM). As a telephone, it offers programmable buttons, fixed feature buttons, a Message light, touch-tone dialing, and a built-in, programmable speakerphone or SPOKESMAN loudspeaker. The speakerphone can be programmed at the terminal by the user for one of three states: On, Disabled, or SPOKESMAN loudspeaker. The 7505 can be equipped with an optional Asynchronous Data Module that provides the user with simultaneous voice and data capabilities. The 7505 equipped with the ADM offers the same voice capabilities as the 7505 equipped with the VOM, plus it allows attached data terminals or personal computers to send and receive data through the digital network.



**NOTE:**

The 7505 voice terminal is no longer being manufactured.

## Applications

---

The 7505 modular terminal can be used with the DEFINITY Communications System Generic 1, Generic 2, and Generic 3, and the DEFINITY ECS. Typical applications of the 7505 are users requiring a large number of line appearances with or without data capabilities.

## Physical Description

---

### Dimensions



**NOTE:**

The following dimensions for the 7505 terminal are approximate.

Width = 8-3/4 inches

Depth (front to back) = 8-1/2 inches

Height (maximum with handset in place) = 6-1/4 inches

### Features

#### Eight Fixed Feature Buttons

The 7505 is equipped with eight fixed feature buttons. Three of the buttons are dual purpose buttons that are used with the SELECT button to perform other functions.

- CONFERENCE/RING button
- DROP/TEST button

17 ISDN Voice Terminals

*The ISDN 7505 Modular Terminal*

17-4

- TRANSFER button
- HOLD button
- SPEAKER button
- MUTE button
- REDIAL/or feature button
- SELECT button

### Message Light

The red Message light goes on when a message is left for the user. It goes off when the user retrieves the message.

### Call Appearance/Feature buttons

The 7505 has nine or 10 call appearance buttons. These same 10 buttons, when properly administered, can be used for activating features. One of these buttons is used as a DATA/SEND/OFF button if the set has data capability.

### Feature-Only Button

The 7505 has three buttons that are used for features. When used with the SELECT button these buttons can be used for three additional custom features. In addition to these three buttons, the REDIAL button provides another custom feature button.

### Self-Test

The 7505 has a local self-test. When used with the SELECT button, the DROP/TEST button begins and ends the self-test.

### MUTE button

Pressing the MUTE button mutes the handset or the speakerphone, whichever is active. The red light next to the MUTE button goes on. The user is placed in a listen-only mode.

### Loudspeaker

The 7505 has a built-in, programmable SPOKESMAN loudspeaker. The SPEAKER button is used to turn the loudspeaker on and off. The Volume arrow buttons control the volume of the loudspeaker.

### Speakerphone

The 7505 has a built-in, programmable speakerphone. The SPEAKER button is used to turn the speakerphone on and off. The green light next to the SPEAKER button goes on when the speakerphone is on. The Volume arrow buttons control the volume of the speakerphone.



**17 ISDN Voice Terminals**

*The ISDN 7505 Modular Terminal*

17-5

## **Other Physical Features**

### **Handset**

The 7505 is equipped with an R-type handset.

### **Dial pad**

The 7505 has a 12-button touch-tone dial pad.

### **Jacks**

The 7505 housing contains three jacks. The Handset jack is located on the bottom of the 7505 and can be identified by the adjacent handset symbol. The Line jack is located on the back of the 7505. The Adjunct jack, used for connection to the optional adjuncts, is located on the bottom of the terminal and can be identified by the adjacent speaker symbol. If the optional ADM is provided, there is an EIA RS-232D Interface connector provided on its back.

### **Cords**

Two cords are supplied with the 7505: a coiled 9-foot modular handset cord and a line cord. An optional 12-foot handset cord is available.

### **Ringling**

The 7505 has electronic tone ringling with patterns that can be selected by using the SELECT and CONFERENCE/RING buttons. The volume is controlled by the volume "arrow" buttons.

### **Mounting Options**

The 7505 comes equipped with a non-adjustable desk stand.

### **Color Options**

The base of the 7505 is always black. The top of the 7505 is available in misty cream or black.

## **Distance Limitations**

The maximum signaling distance from the port board to the work location jack based on DIW 24 AWG cable is:

- Terminating resistor in work location — 1900 feet
- Terminating resistor in satellite closet — 1600 feet

**17 ISDN Voice Terminals**

*The ISDN 7505 Modular Terminal*

17-6

## **Power Requirements**

---

The 7505 requires an auxiliary power supply. The power supply can be provided at a central location or may be collocated with the 7505. If the auxiliary power supply fails or loses its power, the 7505 will provide basic voice service with the phantom power provided by the switch.

## **Terminating Resistor**

---

A 440A4 Terminating Resistor adapter is required with the 7505. The 440A4 can be located at the work location or in the satellite closet.

## **Power Failure Operation**

---

The 7505 cannot be used as an emergency station during power failure transfer conditions.

## **FCC Registration**

---

The 7505 modular terminal is not FCC registered.

## **Hearing Aid Compatible**

---

This voice terminal is compatible with the inductively coupled hearing aids prescribed by the FCC.

## **7505 Equipment PECs**

---

The 7505 modular terminal and optional components were ordered with the following PECs:

- ISDN 7505 Voice Only Modular Terminal — 3195-VOM
- ISDN 7505 Asynchronous Data Modular Terminal — 3195-ADM
- 440A4 Terminating Resistor — 2709-A59
- ADM Upgrade Kit — 31955
- VOM Feature Package 2 Upgrade Kit — 31969
- ADM Feature Package 2 Upgrade Kit — 31970

17 ISDN Voice Terminals

*The ISDN 7505 Modular Terminal*

17-7

## Adjuncts

---

The following adjuncts can be used with the 7505 modular terminal:

- 500A Headset Adapter (and a standard headset; see “Headsets” below)
- S101A Speakerphone
- S201A Speakerphone

## Headsets

A list of compatible headsets, consisting of both modular and plug prong base units and selection of headpieces, appears in “Headset Adapters” in the **Adjuncts** section later in this manual.

## Additional Documents

---

The following documents contain additional information relating to the 7505 modular terminal:

- *DEFINITY Generic 1 7505, 7506, and 7507 Voice Terminal User's Guide*, 555-204-750
- *DEFINITY Generic 2 ISDN 7505, 7506, and 7507 Terminal User's Guide*, 555-104-719
- *ISDN 7505 Modular Terminal and ISDN 7506 Display Terminal User's Manual*, 555-021-714
- *ISDN 7505 Asynchronous Data Module User's Guide*, 555-021-716
- *Integrated Services Digital Network (ISDN) Terminal Installation and Test User's Manual*, 555-021-101

# The ISDN 7506 Voice Terminal

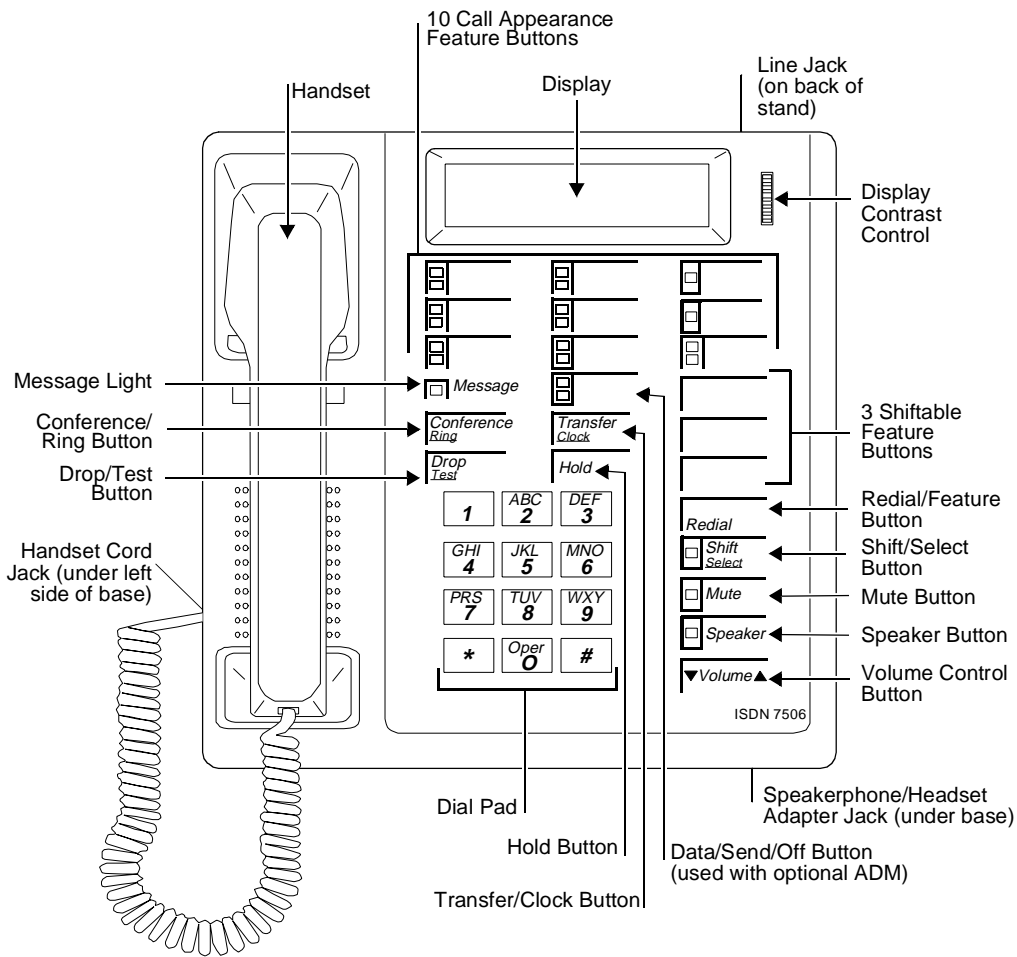

Figure 17-2. The 7506 Asynchronous Data Modular Display Terminal

17 ISDN Voice Terminals

*The ISDN 7506 Voice Terminal*

17-9

The 7506 Display terminal is used with the Integrated Services Digital Network (ISDN) communication system through a 4-wire "T"-interface. The modular 7506 is a voice terminal when equipped with a Voice Only Module (VOM). As a telephone, it offers programmable buttons, fixed feature buttons, a Message light, touch-tone dialing, and a built-in, programmable speakerphone or SPOKESMAN loudspeaker. The speakerphone can be programmed at the terminal by the user for one of three states: On, Disabled, and SPOKESMAN loudspeaker. The 7506 can be equipped with an optional Asynchronous Data Module that provides the user with simultaneous voice and data capabilities. The 7506 equipped with the ADM offers the same voice capabilities as the 7506 equipped with the VOM, plus it allows attached data terminals or personal computers to send and receive asynchronous data through the digital network. Both versions of the 7506 display terminal are equipped with a two-line, 24-character display.



**NOTE:**

The 7506 voice terminal is no longer being manufactured.

## Applications

The 7506 display terminal can be used with the DEFINITY Communications System Generic 1, Generic 2, and Generic 3, and the DEFINITY ECS. Typical applications of the terminal are users requiring a large number of line appearances with or without data. It is particularly useful for middle managers.

## Physical Description

### Dimensions



**NOTE:**

The following dimensions for the 7506 terminal are approximate.

Width = 8-3/4 inches

Depth (front to back) = 8-1/2 inches

Height (maximum with handset in place) = 6-1/4 inches

## Features

### Eight Fixed Feature Buttons

The 7506 display terminal is equipped with eight fixed feature buttons. Four of the buttons are dual purpose buttons that are used with the SELECT button to perform other functions.

- CONFERENCE/RING button
- DROP/TEST button
- TRANSFER/CLOCK button
- SPEAKER button
- MUTE button
- REDIAL/or feature button
- SELECT button

### Message Light

The red Message light goes on when a message is left for the user. It goes off when the user retrieves the message.

### Call Appearance/Feature buttons

The 7506 display terminal has nine or 10 call appearance buttons. These same 10 buttons, when properly administered, can be used for activating features. One of these buttons is used as a DATA/SEND/OFF button if the set has data capability.

### Feature Button

The 7506 display terminal has three buttons that are used for features. When used with the SELECT button, these buttons can be used for three additional custom features. In addition to these buttons, the REDIAL button provides another custom feature button.

### Display

Information shown on the display include the number being dialed, the time and date, and information concerning incoming calls and message retrieval. The viewing contrast is adjusted with the Display Contrast Control wheel located to the right of the display.

### Self-Test

The 7506 display terminal has a local self-test. When used with the SELECT button, the DROP/TEST button begins and ends the self-test.

17 ISDN Voice Terminals

*The ISDN 7506 Voice Terminal*

17-11

## **Loudspeaker**

The 7506 display terminal has a built-in, programmable SPOKESMAN loudspeaker. The SPEAKER button is used to turn the loudspeaker on and off. The volume arrow buttons control the volume of the loudspeaker.

## **Speakerphone**

The 7506 display terminal has a built-in, programmable speakerphone. The SPEAKER button is used to turn the speakerphone on and off. The green light next to the SPEAKER button goes on when the speakerphone is active. The volume arrow buttons control the volume of the speakerphone.

## **MUTE button**

Pressing the MUTE button mutes the handset or the speakerphone, whichever is active. The red light next to the MUTE button goes on. The user is placed in a listen-only mode.

## **Other Physical Features**

### **Handset**

The 7506 is equipped with an R-type handset.

### **Dial pad**

The 7506 has a 12-button touch-tone dial pad.

### **Jacks**

The 7506 housing contains three jacks. The Handset jack is located on the bottom of the 7506 terminal. The Line jack is located on the back of the 7506 terminal. The Adjunct jack, used for connection to the optional adjuncts, is located on the bottom of the terminal. If the optional ADM is provided, there is an EIA RS-232D Interface connector provided on its back.

### **Cords**

Two cords are supplied with the terminal: a coiled 9-foot modular handset cord and a line cord. An optional 12-foot handset cord is available.

### **Ringling**

The 7506 display terminal has electronic tone ringling with patterns that can be selected by using the SELECT and CONFERENCE/RING buttons in sequence. The volume is controlled by the volume arrow buttons.

### **Mounting Options**

The 7506 display terminal comes equipped with a nonadjustable desk stand.

17 ISDN Voice Terminals

*The ISDN 7506 Voice Terminal*

17-12

## Color Options

The base of the 7506 is always black. The top of the 7506 is available in misty cream or black.

## Distance Limitations

---

The maximum signaling distance from the port board to the work location jack based on DIW 24 AWG cable is:

- Terminating resistor in work location — 1900 feet
- Terminating resistor in satellite closet — 1600 feet

## Power Requirements

---

The 7506 display terminal requires an auxiliary power supply. The power supply can be provided at a central location or may be collocated with the 7506 display terminal. If the auxiliary power supply fails or loses its power, the 7506 display terminal will provide basic voice service with the phantom power provided by the switch.

## Terminating Resistor

---

A 440A4 Terminating Resistor adapter is required with the 7506 display terminal. The 440A4 can be located at the work location or in the satellite closet.

## Power Failure Operation

---

The 7506 display terminal cannot be used as an emergency station during power failure transfer conditions.

## FCC Registration

---

The 7506 display terminal is not FCC registered.

## Hearing Aid Compatible

---

This voice terminal is compatible with the inductively coupled hearing aids prescribed by the FCC.



17 ISDN Voice Terminals

*The ISDN 7506 Voice Terminal*

17-13

## 7506 Equipment PECs

---

The 7506 display terminal and optional components were ordered with the following PECs:

- ISDN 7506 Voice Only Modular Display Terminal — 3196-VOM
- ISDN 7506 Asynchronous Data Modular Display Terminal — 3196-ADM
- 440A4 Terminating Resistor — 2709-A59
- ADM Upgrade Kit — 31955
- VOM Feature Package 2 Upgrade Kit — 31969
- ADM Feature Package 2 Upgrade Kit — 31970

## Adjuncts

---

The following adjunct can be used with the 7506 display terminal:

- 500A Headset Adapter (and a standard headset; see “Headsets” below)
- S101A Speakerphone
- S201A Speakerphone

## Headsets

A list of compatible headsets, consisting of both modular and plug prong base units and selection of headpieces, appears in “Headset Adapters” in the **Adjuncts** section later in this manual.

## Additional Documents

---

The following documents contain additional information relating to the 7506 display terminal:

- *DEFINITY Generic 1 7505, 7506, 7507 Voice Terminals User's Guide, 555-204-750*
- *DEFINITY Generic 2 ISDN 7505, 7506, 7507 Terminal User's Guide, 555-104-719*
- *ISDN 7505 Modular Terminal and ISDN 7506 Display Terminal User's Guide, 555-021-714*
- *ISDN 7506 Asynchronous Data Module User's Guide, 555-021-716*
- *Integrated Services Digital Network (ISDN) Terminal Installation and Test User's Manual, 555-021-101*

## The ISDN 7507 Display Terminal

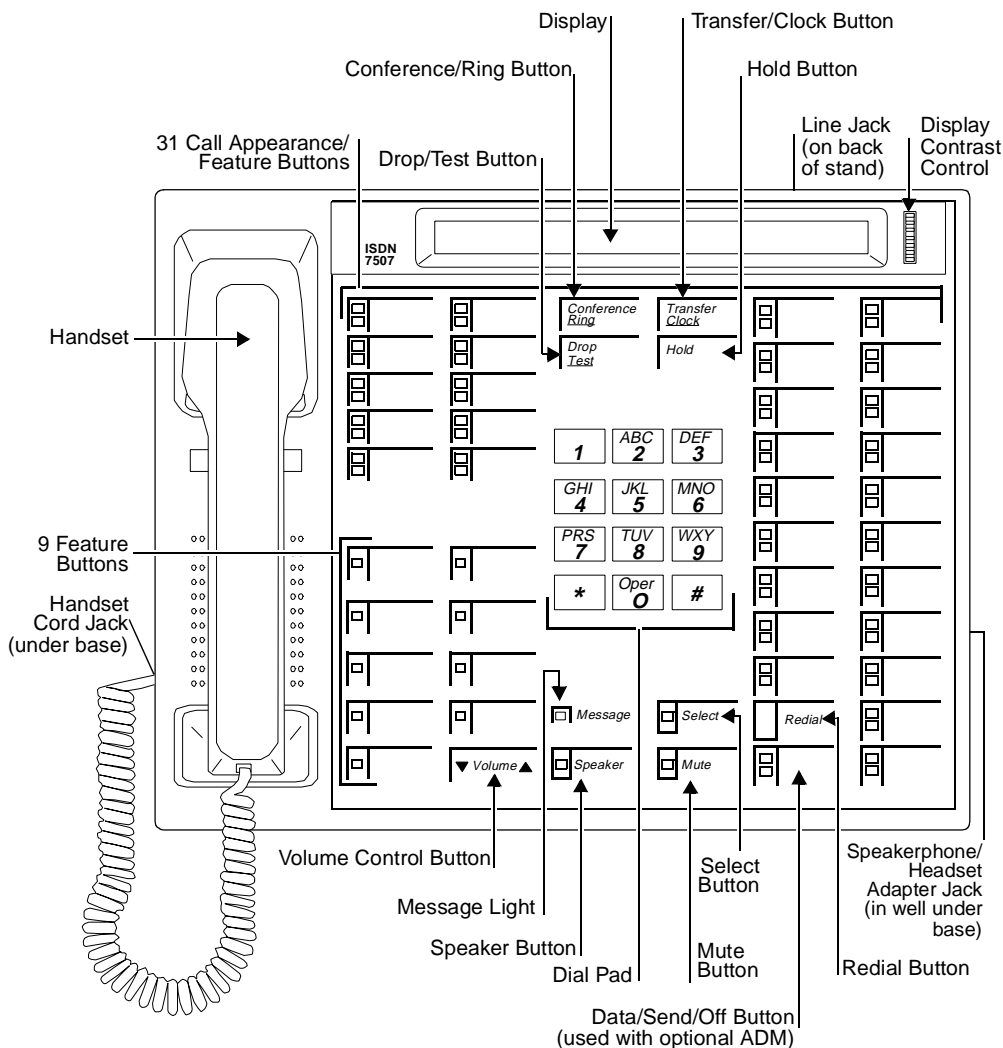

Figure 17-3. The 7507 Asynchronous Data Modular Display Terminal

17 ISDN Voice Terminals

*The ISDN 7507 Display Terminal*

17-15

The 7507 Display terminal is used with the Integrated Services Digital Network (ISDN) communication system through a 4-wire "T"-interface. The modular 7507 is a voice terminal when equipped with a Voice Only Module (VOM). As a telephone it offers programmable buttons, fixed feature buttons, Message light, touch-tone dialing, and a built-in, programmable speakerphone or SPOKESMAN loudspeaker. The speakerphone can be programmed at the terminal by the user for one of three states: On, Disabled, and SPOKESMAN loudspeaker. The 7507 can be equipped with an optional Asynchronous Data Module that provides the user with simultaneous voice and data capabilities. The 7507 equipped with the ADM offers the same voice capabilities as the 7507 equipped with the VOM, plus it allows attached data terminals or personal computers to send and receive data through the digital network. The terminal is equipped with a 2-line, 40-character display.



**NOTE:**

The 7507 voice terminal is no longer being manufactured.

## Applications

---

The 7507 display terminal can be used with the DEFINITY Communications System Generic 1, Generic 2, and Generic 3, and the DEFINITY ECS. Typical applications of the display terminal are users requiring a large number of line appearances with or without data capabilities. It is particularly useful for secretary/receptionist positions and executives.

## Physical Description

---

### Dimensions



**NOTE:**

The following dimensions for the 7507 terminal are approximate.

Width = 12 inches

Depth (front to back) = 8-3/4 inches

Height (maximum with handset in place) = 5-1/4 inches

## Features

### Eight Fixed Feature Buttons

The 7507 display terminal is equipped with eight fixed feature buttons. Three of the buttons are dual purpose buttons that are used with the SELECT button to perform other functions.

- CONFERENCE/RING button
- DROP/TEST button
- TRANSFER/CLOCK button
- HOLD button
- SPEAKER button
- MUTE button
- REDIAL button
- SELECT button

### Message Light

The red Message light goes on when a message is left for the user. It goes off when the user retrieves the message.

### Call Appearance/Feature buttons

The 7507 display terminal has 30 or 31 call appearance buttons. These same 31 buttons, when properly administered, can be used for activating features. One of these buttons is used as a DATA/SEND/OFF button if the set has data capability.

### Feature Button

The 7507 display terminal has nine buttons that are used for features. When used with the SELECT button, these buttons can be used for nine additional custom features. In addition to these buttons, the REDIAL button provides another custom feature button.

### Display

Information shown on the display include the number being dialed, the time and date, and information concerning incoming calls and message retrieval. The viewing contrast is adjusted with the Display Contrast Control wheel located to the right of the display.

### Self-Test

The 7507 display terminal has a local self-test. When used with the SELECT button, the DROP/TEST button begins and ends the self-test.

17 ISDN Voice Terminals

*The ISDN 7507 Display Terminal*

17-17

### **Loudspeaker**

The 7507 display terminal has a built-in, programmable SPOKESMAN loudspeaker. The SPEAKER button is used to turn the loudspeaker on and off. The Volume arrow buttons control the volume of the loudspeaker.

### **Speakerphone**

The 7507 display terminal has a built-in, programmable speakerphone. The SPEAKER button is used to turn the speakerphone on and off. The green light next to the SPEAKER button goes on when the speakerphone is active. The Volume arrow buttons control the volume of the speakerphone.

### **MUTE button**

Pressing the MUTE button mutes the handset or the speakerphone, whichever is active. The red light next to the MUTE button goes on. The user is placed in a listen-only mode.

## **Other Physical Features**

### **Handset**

The 7507 display terminal is equipped with an R-type handset.

### **Dial pad**

The 7507 display terminal has a 12-button touch-tone dial pad.

### **Jacks**

The 7507 display terminal housing contains three jacks. The Handset jack is located on the bottom of the terminal and can be identified by the adjacent handset symbol. The Line jack is located on the back of the terminal. The Adjunct jack, used for connection to the optional adjuncts, is located on the bottom of the terminal and can be identified by the adjacent speaker symbol. If the optional ADM is provided, there is an EIA RS-232D Interface connector provided on its base.

### **Cords**

Two cords are supplied with the 7507 display terminal: a coiled 9-foot modular handset cord and a line cord. An optional 12-foot handset cord is available.

### **Ringling**

The 7507 display terminal has electronic tone ringling with patterns that can be selected by using the SELECT and CONFERENCE/RING buttons in sequence. The volume is controlled by the Volume arrow buttons.

### **Mounting Options**

The 7507 display terminal comes equipped with a nonadjustable desk stand.

**17 ISDN Voice Terminals**

*The ISDN 7507 Display Terminal*

17-18

## **Color Options**

The base of the 7507 display terminal is always black. The top of the 7507 display terminal is available in misty cream or black.

## **Distance Limitations**

---

The maximum signaling distance from the port board to the work location jack based on DIW 24 AWG cable is:

- Terminating resistor in work location—1900 feet
- Terminating resistor in satellite closet—1600 feet

## **Power Requirements**

---

The 7507 display terminal requires an auxiliary power supply. The power supply can be provided at a central location or may be collocated with the 7507 display terminal. If the auxiliary power supply fails or loses its power, the 7507 display terminal will provide basic voice service with the phantom power provided by the switch.

## **Terminating Resistor**

---

A 440A4 Terminating Resistor adapter is required with the 7507 display terminal. The 440A4 can be located at the work location or in the satellite closet.

## **Power Failure Operation**

---

The 7507 display terminal cannot be used as an emergency station during power failure transfer conditions.

## **FCC Registration**

---

The 7507 display terminal is not FCC registered.

## **Hearing Aid Compatible**

---

This voice terminal is compatible with the inductively coupled hearing aids prescribed by the FCC.

17 ISDN Voice Terminals

*The ISDN 7507 Display Terminal*

17-19

## 7507 Equipment PECs

---

The 7507 display terminal and optional components were ordered with the following PECs:

- ISDN 7507 Voice Only Modular Display Terminal — 3197-VOM
- ISDN 7507 Asynchronous Data Modular Display Terminal — 3197-ADM
- 440A4 Terminating Resistor — 2709-A59
- ADM Upgrade Kit — 31955
- VOM Feature Package 2 Upgrade Kit — 31969
- ADM Feature Package 2 Upgrade Kit — 31970

## Adjuncts

---

The following adjunct can be used with the 7507 display terminal:

- 500A Headset Adapter (and a standard headset; see “Headsets” below)
- S101A Speakerphone
- S201A Speakerphone

## Headsets

A list of compatible headsets, consisting of both modular and plug prong base units and selection of headpieces, appears in “Headset Adapters” in the **Adjuncts** section later in this manual.

## Additional Documents

---

The following documents contain additional information relating to the 7507 Display terminal:

- *DEFINITY Generic 1 7505, 7506, 7507 Voice Terminals User's Guide*, 555-204-750
- *DEFINITY Generic 2 ISDN 7505, 7506 7507 Terminal User's Guide*, 555-104-709
- *ISDN 7507 Display Terminal User's Manual*, 555-021-715
- *ISDN 7507 Asynchronous Data Module User's Guide*, 555-021-716
- *Integrated Services Digital Network (ISDN) Terminal Installation and Test User's Manual*, 555-021-101

## The ISDN 8503 Voice Terminal

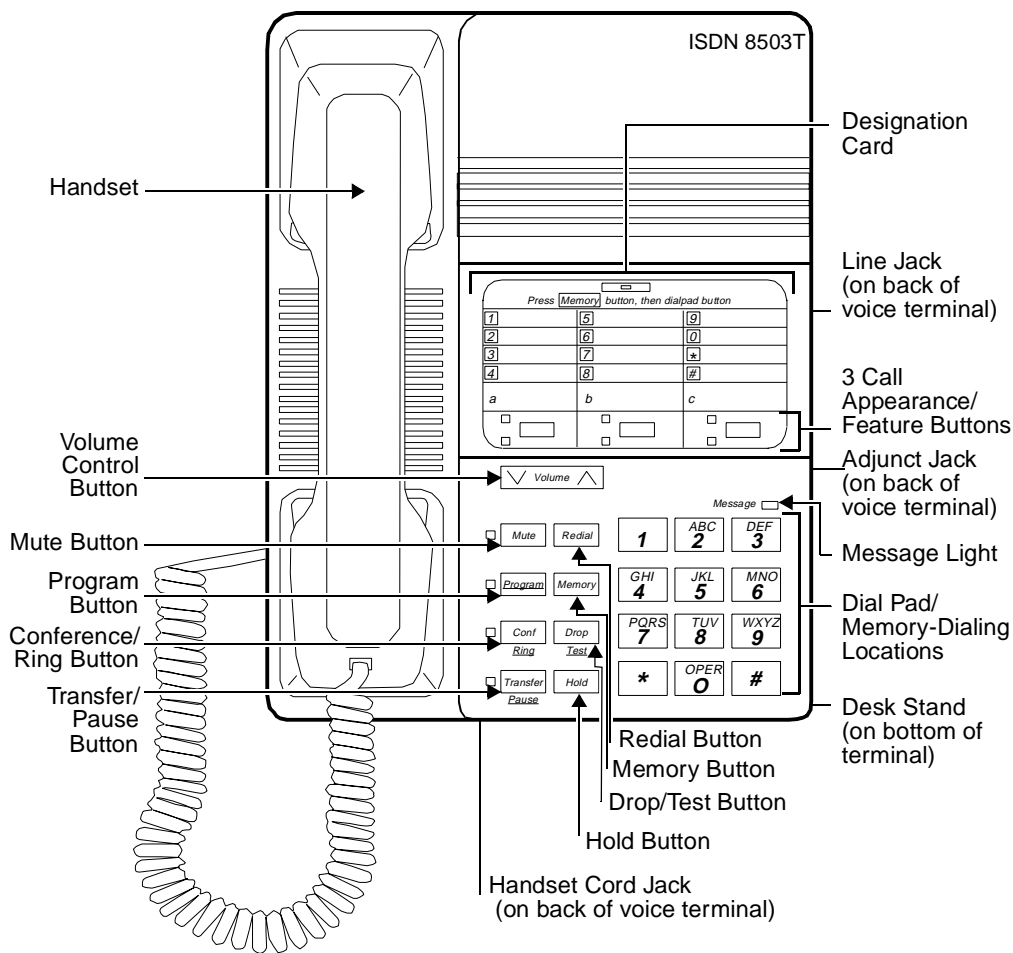

Figure 17-4. The Desk-mounted ISDN 8503T Voice Terminal



17 ISDN Voice Terminals

*The ISDN 8503 Voice Terminal*

17-21

The 8503T voice terminal is a non-modular set used with the ISDN communication system through a 4-wire "T"-interface. This voice terminal offers the following: four standard fixed feature buttons, a Message light, three call appearance/flexible feature buttons, each with a red and green light, 12 programmable memory-dialing locations on the dial pad keys, a PROGRAM button for storing numbers at the memory-dialing locations and a MEMORY button for dialing these programmed numbers or codes, the Redial feature, the Mute feature, eight possible personalized ringing patterns selected with the Select Ring feature, high fidelity audio capabilities (bandwidth from .3 to 3.8 kHz) with the K-type handset, and touch-tone dialing. This set does not provide data capabilities.

## Applications

---

The 8503T voice terminal can be used with the DEFINITY Communications System Generic 2 and Generic 3, and the DEFINITY ECS. Typical applications of the 8503T voice terminal are users handling a low volume of voice-only calls, staff workers and lower level managers, as well as lobbies and conference rooms.

## Physical Description

---

### Dimensions

 NOTE:

The dimensions given here for the 8503T voice terminal are approximate.

Width = 7-3/4 inches

Depth (front to back) = 9-1/2 inches

Height (maximum with handset in place)

The desk-mounted model = 5-1/4 inches

The wall-mounted model = 4-1/2 inches

### Features

#### Four Standard Fixed Features

- CONF/RING button
- DROP/TEST button
- TRANSFER/PAUSE button
- HOLD button

## Message Light

The red Message light goes on when a message is left for the user. This light goes off when the user retrieves the message.

## Call Appearance/Feature buttons

The 8503T voice terminal has three call appearance/flexible feature buttons, each with a red light and a green status light. Although the buttons can accommodate *either* call appearances or administered features, it is highly suggested that all three of these call appearance/feature buttons be used for call appearances.

## Twelve Programmed Memory Locations

The dial pad can be used for storing and dialing frequently dialed telephone numbers, emergency numbers, or feature access codes. In order to store these numbers or codes at each of the 12 memory-dialing locations, the user presses the PROGRAM button, dials the telephone number to be stored, presses the MEMORY button, and then the appropriate dial pad key (1 through 9, 0, \*, and #). To dial the number, the user presses the MEMORY button and the dial pad key where that number is stored. Up to 16 digits can be stored at a memory-dialing location.

## PROGRAM button

The PROGRAM button can be used in three different ways: (When the voice terminal is in program mode, the red light beside the PROGRAM button is on.)

- Used to enter programming mode and store frequently dialed telephone numbers, emergency numbers, or feature access codes on each of the 12 dial pad keys (memory-dialing locations).

### NOTE:

The user can press the TRANSFER/PAUSE button, while the voice terminal is in program mode, to insert a one and one half-second pause/delay in the telephone number to be stored in a memory-dialing location. For example, the user might place a one and one half-second pause between the dialing access code (such as 9) and the outside telephone number.

- Used with the CONF/RING button to select one of eight possible personalized ringing patterns
- Used with the DROP/TEST button to initiate a self-test of the voice terminal lights and ringer

### NOTE:

If the user picks up on an incoming call while the voice terminal is in program mode, the voice terminal will automatically exit program mode.

### **MEMORY button**

When the user presses the MEMORY button and one of the 12 dial pad keys (memory-dialing locations), while off-hook, the voice terminal automatically dials the number or access code stored on that dial pad key.

The user can clear a memory-dialing location by entering program mode, and then pressing the MEMORY button and the appropriate dial pad key on which the number or code is stored.

### **REDIAL button**

With the Redial feature, the user can redial the telephone number last dialed from the dial pad. (The handset must be off-hook.) Up to 37 digits can be redialed.

### **MUTE button**

While on a call, the user can press the MUTE button (the red light next to the button goes on), so the user can converse with someone in the same room without the other party hearing the conversation. The user is placed in listen-only mode. To disable the feature, the user presses the MUTE button a second time. (The red light goes off.)

### **Volume control button**

When the user is on a call, the Volume "arrow" button raises or lowers the volume on the handset. When the handset is on-hook, this button raises or lowers the ringer volume.

### **Self-Test**

The 8503T voice terminal is equipped with a Self-Test feature. When the user presses the PROGRAM button and then the DROP/TEST button, while on-hook, the user can test the button lights and the ringer.

## **Other Physical Features**

### **Handset**

The 8503T voice terminal is equipped with a K-type wideband handset. With the 8503T voice terminal, this handset has high fidelity audio capabilities.

A K-type Noisy Environment Handset (PEC: 31052A) can also be purchased and connected to the 8503T voice terminal.

### **Dial pad**

The 8503T voice terminal is equipped with a standard 12-button touch-tone dial pad for dialing telephone numbers or accessing features.

The dial pad keys can also be used as memory-dialing locations. By pressing the PROGRAM button to enter program mode, the user can store a programmed

**17 ISDN Voice Terminals**

*The ISDN 8503 Voice Terminal*

17-24

number or access code on each of the 12 dial pad keys (memory-dialing locations). With the MEMORY button, the user can dial these programmed numbers.

### **Ringling**

The 8503T voice terminal has electronic tone ringing with eight possible personalized ringing patterns that can be selected by pressing the PROGRAM button and then the CONF/RING button, while on-hook. Ringer volume is controlled by the Volume "arrow" button when the voice terminal is on-hook.

### **Jacks**

The 8503T voice terminal housing contains three jacks. The Handset cord jack, for connecting the handset to the voice terminal, is located on the bottom of the housing, near the front of the voice terminal. The Line jack, for connecting the line cord to the voice terminal, is located on the bottom (left center) of the voice terminal. The Adjunct jack, which is located on the bottom of the voice terminal directly below the Line jack, is used for connecting optional adjunct equipment such as an S201A Speakerphone or a 500A Headset Adapter to the voice terminal.

### **Cords**

Two cords are supplied with the 8503T voice terminal: a coiled 9-foot modular Handset cord and a 7-foot Line cord. An optional 12-foot Handset cord is available.

### **ROM cartridge**

A ROM cartridge is installed in each voice terminal, but is easily removed and replaced so that the firmware can always be updated. The cartridge can be removed from the bottom of the housing by pressing the tab on the cartridge and then lifting it from the housing. The cartridge can be inserted into the housing by pressing the tab on the cartridge and then pressing it down into the bottom of the housing.

### **Mounting Options**

The 8503T voice terminal comes equipped with a desk stand. However, the desk stand can be removed, and the voice terminal can be mounted on the wall.

### **Color Options**

The 8503T voice terminal is available in black or in white.

17 ISDN Voice Terminals

The ISDN 8503 Voice Terminal

17-25

## Distance Limitations

---

For a DEFINITY G2 and G3 and a DEFINITY ECS, in which multipoint configuration is used, the maximum signaling distance possible from the port board to the work location jack is: (The terminating resistor should be within 250 feet of the work location; the distances listed are applicable for up to two voice terminals.)

- If 24 AWG cable is used = 1600 feet
- If 26 AWG cable is used = 1330 feet

## Power Requirements

---

### Phantom or Auxiliary Power

The 8503T voice terminal can receive power from the switch or from an auxiliary power supply. The installer can select the type of power used by setting two jumpers on the bottom of the voice terminal under a sliding plate between the Line jack and the Adjunct jack. A pictorial representation of the jumpers is located to the right of the sliding plate. These jumpers are labeled PHAN (phantom power) and AUX (auxiliary power). The voice terminal is shipped in the PHAN position. You must verify that the jumper settings are set correctly for your configuration.

#### NOTE:

The power jumpers must be set *only* by qualified service personnel.

- PHAN (phantom power) should be selected when power is provided by the PBX. When the jumpers are set to PHAN, less than one Watt of power will be drawn from the switch to support normal operation.
- AUX (auxiliary power) should be selected when power is provided in the closet. When the jumpers are set to AUX, the 8503T voice terminal will operate on a nominal 40 or 48 Vdc, UL-listed Communications Circuit Power source.

17 ISDN Voice Terminals

The ISDN 8503 Voice Terminal

17-26

## Terminating Resistors

The terminating resistor jumpers are located on the bottom of the voice terminal under a sliding plate between the Line jack and Adjunct jack. These jumpers enable (ON) or bypass (OFF) the terminating resistor. The set is shipped with the jumpers in the OFF position bypassing the terminating resistor. You must verify that the jumper settings are set correctly for your configuration.

### NOTE:

The terminating resistor jumpers must be set *only* by qualified service personnel.

- The terminating resistor jumpers must be set to OFF when the set is in a point-to-point configuration and the terminating resistor is in the closet or a 440A4 is connected on the line.
- The terminating resistor jumpers must be set to ON when the set is in a point-to-point configuration and the terminating resistor is *not* in the closet or a 440A4 is *not* connected to the line.
- The terminating resistor jumpers must be set to OFF when the set is in a multipoint configuration and the terminating resistor is in the closet, a 440A4 is connected on the line, or the jumper is set to ON in one of the other sets on the line.
- The terminating resistor jumpers must be set to ON when the set is in a multipoint configuration and the terminating resistor is *not* in the closet, a 440A4 is not connected on the line, or the jumper is not set to ON in any of the other sets on the line.

## Switch Administration

---

The 8503T voice terminal should be administered as an ISDN 7505 voice terminal.

### NOTE:

The three call appearance/feature buttons can be used for call appearances or features, but, for most effective use of the voice terminal, it is strongly suggested that all three buttons be administered for call appearances.

## Power Failure Operation

---

The 8503T voice terminal cannot be used as an emergency station during power failure transfer conditions.

## FCC Registration

---

The 8503T voice terminal is FCC registered.

17 ISDN Voice Terminals

*The ISDN 8503 Voice Terminal*

17-27

## Hearing Aid Compatible

---

This voice terminal is compatible with the inductively coupled hearing aids prescribed by the FCC.

## 8503T Equipment PECs and Comcodes

---

The 8503T voice terminal and optional components can be ordered with the following PECs and Comcodes:

- **ISDN 8503T Voice Terminal**  
PEC: 3114-001 (Black=COL09; White=COL10)  
Comcode: Black=106604341; White=106604358
- **Handset**  
PEC: 31149 (Black=COL09; White=COL10)  
Comcode: Black=106050065; White=106053408
- **Handset cord (9 feet)**  
Comcode: Black=105635429; White=105701809
- **Handset cord (12 feet)**  
PEC: 2725-01L (Black=COL09; White=COL10)  
Comcode: Black=102401445; White=104211339
- **Line cord (7 feet)**  
PEC: 2725-07G  
Comcode: 103786778
- **Designation card**  
PEC: 31140  
Comcode: 846558039

## Adjuncts

---

The following adjuncts can be used with the 8503T voice terminal:

- 500A Headset Adapter (and a standard headset; see "Headsets" below)
- S101A Speakerphone (no longer orderable)
- S201A Speakerphone

## Headsets

A list of compatible headsets, consisting of both modular and plug prong base units and selection of headpieces, appears in "Headset Adapters" in the **Adjuncts** section later in this manual.

**17 ISDN Voice Terminals**

*The ISDN 8503 Voice Terminal*

17-28

**Additional Documents**

---

The following documents contain additional information relating to the 8503T voice terminal: (Use the 9-digit number listed after each document to order the book from the BCS Publications Center for Lucent Technologies.)

- *ISDN 8503T Voice Terminal User's Manual, 555-021-726*
- *DEFINITY Generic 3 ISDN 8503T Voice Terminal User's Guide, 555-204-747*
- *DEFINITY Generic 2 ISDN 8503T Voice Terminal User's Guide, 555-104-747*
- *Integrated Services Digital Network (ISDN) Terminal Installation and Tests, 555-021-101*



17 ISDN Voice Terminals

The ISDN 8510 Voice/Data Terminal

17-29

# The ISDN 8510 Voice/Data Terminal

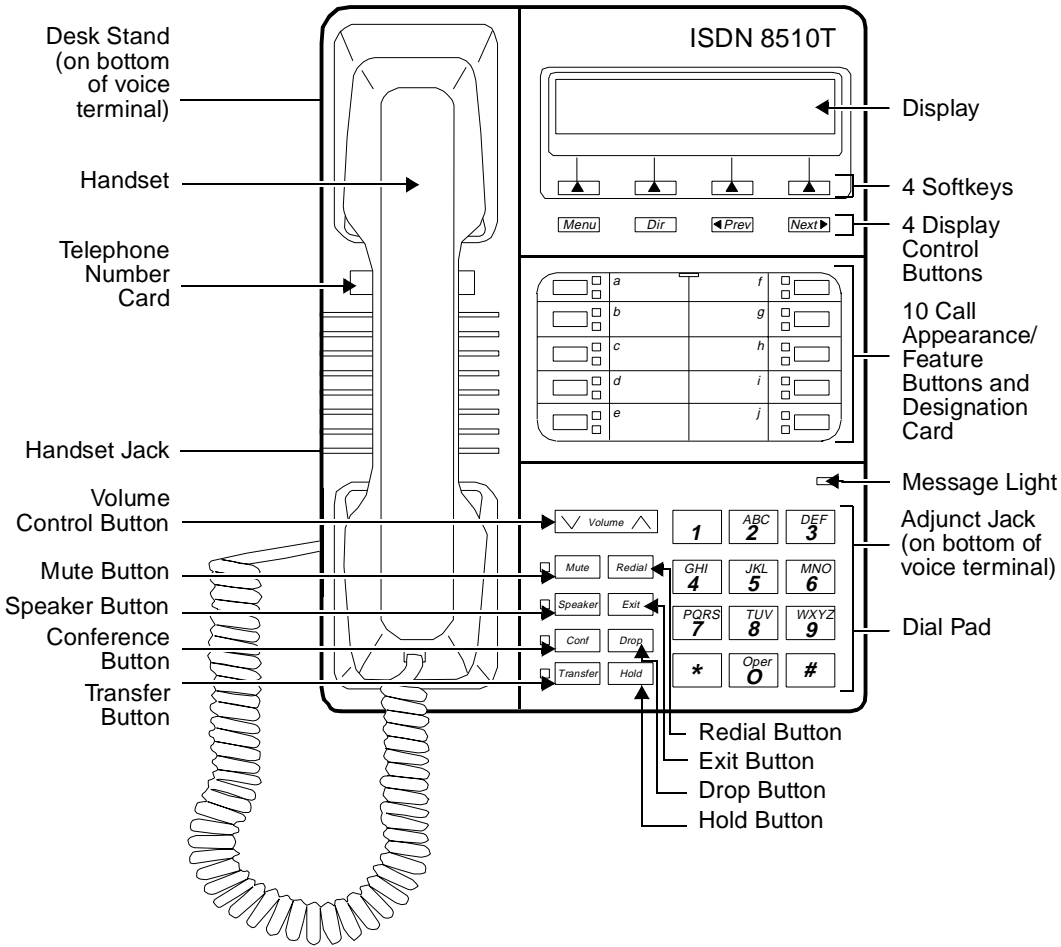

Figure 17-5. The ISDN 8510T Voice/Data Terminal

17 ISDN Voice Terminals

*The ISDN 8510 Voice/Data Terminal*

17-30

The 8510T voice/data terminal is used with the Integrated Services Digital Network (ISDN) communication system through a 4-wire "T"-interface. The 8510T voice/data terminal offers the following: 10 call appearance/feature buttons, each with a red and green status light, buttons for the Mute, Redial, Conference, Drop, Transfer, and Hold features (the MUTE, SPEAKER, CONF, and TRANSFER buttons have a red light next to them), a Speakerphone which can also be optioned as a listen-only Speaker, a Volume control, the K-type handset which offers improved acoustic quality, an Adjunct jack for adjunct equipment, and touch-tone dialing. Four softkeys (the keys with arrows printed on them) and four display control buttons located below a 2-line by 24-character liquid crystal display can be used to access such features as a personal Directory, a Call Log which lists the most recent incoming and outgoing calls, the Self-Test feature, and a personalized ringing pattern for the terminal.

## Applications

The 8510T voice/data terminal can be used with the DEFINITY Communications System Generic 2 and Generic 3, and the DEFINITY ECS. It can be used as a voice terminal, data terminal, or a video phone. For the last two applications, you will need to install a special (data or video) board in the 8510T voice terminal.

## Physical Description

### Dimensions



**NOTE:**

The dimensions given here for the 8510T voice/data terminal are approximate.

Width = 7-3/4 inches

Depth (front to back) = 9-1/2 inches

Height (maximum with handset in place)

The desk-mounted model = 5-1/4 inches

The wall-mounted model = 4-1/2 inches

17 ISDN Voice Terminals

The ISDN 8510 Voice/Data Terminal

17-31

## Features

### Nine Fixed Features

- CONF button
- DROP button
- TRANSFER button
- HOLD button
- MUTE button
- SPEAKER button
- EXIT button
- REDIAL button
- VOLUME control button

### Message Light

The red Message light goes on when a message is left for the user. This light goes off when the user retrieves the message.

### Call Appearance/Feature buttons

These 10 buttons are devoted *either* to handling incoming and outgoing calls (call appearances) and are labeled with the exchange (numbers) and extension number *or* they can be used as feature buttons to access voice features such as Call Forward or Send All Calls; these are labeled with the feature name. Each of these 10 call appearance/feature buttons has a red light, which indicates the selected line and a green light which indicates the status of that line or feature.

### REDIAL button

With the Redial feature, the user can redial the telephone number last dialed from the dial pad. (The handset must be off-hook, or the speaker must be active.) Up to 37 digits can be redialed.

### Speakerphone (Listen and Speak) Feature

The 8510T voice/data terminal is equipped with a built-in S201A-type speakerphone. The Speakerphone capability allows a user to engage in a hands-free 2-way conversation with the far-end party. The speakerphone can be turned off or on with the SPEAKER button; it can be muted with the MUTE button, and the volume can be controlled with the VOLUME “arrow” button.

With the softkeys, the user can adjust the speakerphone for optimal performance. The user hears a set of tones as the speakerphone performs an acoustic test of the environment. When the tones stop, the speakerphone has finished adjusting itself and is ready for use. The user should reset the speakerphone whenever the voice terminal (or the table or desk on which the terminal is situated) is moved to another place (even in the same room).

## Speaker (Listen-only) Feature

The 8510T voice/data terminal can be optioned for the Speakerphone (listen and speak) or the Speaker (listen-only) feature. (The voice terminal is shipped with the Speakerphone setting in place.)

The Speaker (listen-only) capability allows a user to engage in a one-way conversation with the far-end. The user can only listen to the far-end; the user is not able to transmit his voice over the speaker. Use the SPEAKER button on the front of the voice terminal for turning on and off the speaker or speakerphone. To speak with the far-end, the user must use the handset. Lifting the handset turns off the speaker.

## MUTE button

While on a call, the user can press the MUTE button (the red light next to the button goes on), so the user can converse with someone in the same room without the other party hearing the conversation. The user is placed in listen-only mode. To disable the feature, the user presses the MUTE button a second time (the red light goes off). The Mute function works only with the handset or with the built-in speakerphone.

## EXIT button

The EXIT button is used for exiting a softkey feature and returning to Normal call-handling Mode.

## VOLUME control button

When the user is on a call using the speakerphone, the VOLUME "arrow" button raises or lowers the volume on the speakerphone. Likewise, when the user is on a call using the handset, the VOLUME control changes the receive level of the handset. When the handset is on-hook and the speakerphone is off, this button raises or lowers the ringer volume and tones such as the confirmation and error tone.

## Softkeys

The four buttons located below the display and labeled with arrows (▲), correspond to words on the display screen. Softkeys are used along with display control keys to access the following features:

- Setting the clock
- Setting the speakerphone
- Adding, editing, and deleting the numbers and associated names in the voice terminal Directory
- Viewing a Directory entry and then placing a call to the number currently shown on the display screen
- Using  to quickly place a call to a number located in your Directory
- Using the Call Log to view incoming and/or outgoing calls

## 17 ISDN Voice Terminals

### *The ISDN 8510 Voice/Data Terminal*

17-33

- Choosing to display an indicator when new calls are logged
- Locking and unlocking the Directory, Call Log, and all softkey functions
- Changing or removing your password
- Initiating a self-test of the voice terminal's lights, ringer, buttons, and dial pad keys
- Selecting the contrast level for the display
- Selecting a personalized ringing pattern
- Setting the rate at which the display messages are shown on the screen
- Adding confirmation or error tones to display messages
- Setting the number of names on a Directory page
- On an 8510 voice/data terminal, setting data features (See "Data Features" later in this section for more information on data features.)

### Display control buttons

These four buttons are labeled **Menu**, **Dir**, **◀ Prev**, and **Next ▶**.

- **Menu** is used to access the main softkey menu.
- **Dir** allows you to quickly access Directory entries in order to place a call.
- **◀ Prev** and **Next ▶** can be used to help you go back and forth through menu options, to add, edit, or search for an entry in your Directory, and to view entries in your Call Log.

## Other Physical Features

### Handset

The 8510T is equipped with a K-type handset.

A K-type Noisy Environment Handset (PEC: 31052A) can also be purchased and connected to the 8510T terminal.

### Dial pad

The 8510T is equipped with a standard 12-button touch-tone dial pad for dialing telephone numbers or accessing features. The letters "Q" and "Z" have been added to the appropriate dial pad keys for directory access, and the "5" button on your dial pad has raised bars for visually-impaired users.

## Kickstand

The kickstand on the bottom of the terminal can be lifted from the desktop stand or can be left level with the bottom of the terminal. The user should check which kickstand adjustment allows the best viewing angle of the display.

### NOTE:

When the kickstand is raised or lowered, the speakerphone should be re-calibrated to compensate for the new position.

## Ringling

The 8510T has electronic tone ringing with eight possible personalized ringing patterns that can be selected through the softkeys and the display control buttons. Ringer volume is controlled by the VOLUME "arrow" button when the terminal is on-hook.

## Jacks

The 8510T voice/data terminal housing contains three jacks. The Handset cord jack, for connecting the handset to the terminal, is located on the bottom of the housing, near the front of the terminal. The Line jack, for connecting the line cord to the terminal, is located on the bottom (left center) of the terminal. The Adjunct jack, which is located on the bottom of the voice terminal directly below the Line jack, is used for connecting optional adjunct equipment such as an S201A Speakerphone or a 500A Headset Adapter to the terminal.

### NOTE:

When an ADB (board) is installed in the 8510T terminal for data operations, the RS232 jack is visible on the rear of the set for connecting data equipment. When a TMI board is installed in the 8510T, two jacks are visible on the rear of the set: the RS232 for the data connection and an 8-pin round connector for connection of a video cable.

## Cords

Two cords are supplied with the 8510T: a coiled 9-foot modular Handset cord and a 7-foot Line cord. An optional 12-foot Handset cord is available.

## ADB and TMI Boards

An Asynchronous Data Board (ADB) can be installed in the 8510T for data applications. A TMI (Telephone Multimedia Interface) board can be installed if the 8510T is to be used as a video terminal.

## Mounting Options

The 8510T comes equipped with a desk stand. However, the desk stand can be removed, and the terminal can be mounted on the wall. If you choose to wall-mount the voice terminal, use the instructions included in the 8510T Voice Terminal Wall Mounting Kit (Comcode: 106614894).

17 ISDN Voice Terminals

*The ISDN 8510 Voice/Data Terminal*

17-35

## Color Options

The 8510T is available in black or in white.

## Data Features

---

- Asynchronous full-duplex operation at data rates from 1200 bits per second (bps) to 57.6 kilobits per second (kbps) through an EIA-232 interface.
- X.25 packet switched data communication including receipt of X.29 commands from a remote X.25 host for setting packet switched data parameters.
- Circuit switched data communication over 56 or 64 kbps facilities via industry standard V.120 rate adaption protocol.
- Circuit switched data communication over 64 kbps facilities via Lucent Technologies' Digital Multiplexed Interface (DMI) Mode 2 or Mode 3 rate adaption protocols.
- API allows a PC to control all aspects of the set's interaction with the user and with the network.
- The four softkeys and four display control buttons located below the liquid crystal display can be used to access data features such as view current options, change options, answer a data call, place a data call, reset a locked data set, and selecting to display a data indicator.
- A user friendly command interface with on-screen help, nine programmable named data memory numbers, and four programmable data option profiles.
- An expanded Hayes AT command set interface for compatibility with applications which require this command format.
- Remote and local loopback tests.

For more information about the data features on an 8500-Series terminal, see the *ISDN 8500 Series Display Terminal ADM User's Manual*, 555-021-730.

## Distance Limitations

---

For the DEFINITY G2 and G3 and DEFINITY ECS, in which multipoint configuration is used, the maximum signaling distance possible from the port board to the work location jack is:

 **NOTE:**

The terminating resistor should be within 250 feet of the work location; the distances listed are applicable for up to two voice/data terminals.

- If 24 AWG cable is used = 1600 feet
- If 26 AWG cable is used = 1330 feet

## Power Requirements

---

### Phantom or Auxiliary Power

The 8510T can receive power from the switch or from an auxiliary power supply.

#### NOTE:

A voice/data set should be auxiliary powered only.

The installer can select the type of power used by placing the two power jumpers over the correct set of pins.

The power option jumpers are located at the bottom center of the terminal. On the right side of the pins, on the plastic housing, you will see the label **POWER** and a diagram of the correct settings. The jumpers are labeled **PHAN** (phantom power) and **AUX** (auxiliary power). The terminal is shipped in the AUX position. You must verify that the jumper settings are set correctly for your configuration.

#### NOTE:

The power jumpers must be set *only* by qualified service personnel.

- PHAN (phantom power) should be selected when power is provided by the PBX. When the jumpers are set to PHAN, in idle condition, less than one Watt of power will be drawn from the switch. The power option resistors are set to PHAN if each of the two jumpers covers the two top pins in each set. (The bottom pin in each set is left uncovered.)
- AUX (auxiliary power) should be selected when power is provided in the closet. When the jumpers are set to AUX, the 8510T will operate on a nominal 40 or 48 Vdc, UL-listed Communications Circuit Power source. The power option resistors are set to AUX if each of the two jumpers covers the two lower pins in each set. (The top pin in each set is left uncovered.)

#### NOTE:

It is a requirement that 8510T voice only terminals in a multipoint configuration (two or more terminals per port) be auxiliary powered. If used **ONLY** in a point-to-point configuration (one terminal per port), 8510T terminals may be phantom powered. When used in a mixed point-to-point and multipoint configuration, all 8510T terminals **MUST** be auxiliary powered.

If a phantom powered 8510T is moved from an existing point-to-point to a multipoint configuration, the power jumper must be changed from PHAN to AUX, and the terminal connected to an auxiliary power source. The terminal will still work in the PHAN mode, but the power jumper must still be changed. Exceeding the phantom power capacity will trip the breaker in the carrier, causing a loss of service.



**17 ISDN Voice Terminals***The ISDN 8510 Voice/Data Terminal*

17-37

Recommended power supplies are the 1151A1 and 1151A2 with Battery Holdover, and MSP-1 (local) Power Supplies and the 1145A and 1145B1 Bulk Power Supplies.

**Terminating Resistors**

The terminating resistor jumpers are located on the upper left side on the bottom of the terminal. Above the pins, on the plastic housing, you will see the label **TERM RESISTOR** and a diagram of the correct settings.

These jumpers enable (ON) or bypass (OFF) the terminating resistor. The set is shipped with the jumpers in the OFF position bypassing the terminating resistor. You must verify that the jumper settings are set correctly for your configuration.

**NOTE:**

The terminating resistor jumpers must be set *only* by qualified service personnel.

- The terminating resistor jumpers must be set to OFF when the set is in a point-to-point configuration and the terminating resistor is in the closet or a 440A4 is connected on the line. When set to OFF, each of the two terminating resistor jumpers covers the two top pins in each set. (The bottom pin in each set is left uncovered.)
- The terminating resistor jumpers must be set to ON when the set is in a point-to-point configuration and the terminating resistor is *not* in the closet or a 440A4 is *not* connected to the line. When set to ON, each of the two terminating resistor jumpers covers the two lower pins in each set. (The top pin in each set is left uncovered.)
- The terminating resistor jumpers must be set to OFF when the set is in a multipoint configuration and the terminating resistor is in the closet, a 440A4 is connected on the line, or the jumper is set to ON in one of the other sets on the line. When set to OFF, each of the two terminating resistor jumpers covers the two top pins in each set. (The bottom pin in each set is left uncovered.)
- The terminating resistor jumpers must be set to ON when the set is in a multipoint configuration and the terminating resistor is *not* in the closet, a 440A4 is not connected on the line, or the jumper is not set to ON in any of the other sets on the line. When set to ON, each of the two terminating resistor jumpers covers the two lower pins in each set. (The top pin in each set is left uncovered.)

**Switch Administration**

---

Use the following information for administering an ISDN 8510T voice terminal.

- An 8510T voice terminal connected to a DEFINITY G2 should be aliased as a 7507 voice terminal.

## 17 ISDN Voice Terminals

### *The ISDN 8510 Voice/Data Terminal*

17-38

- An 8510T voice terminal connected to a DEFINITY G3 or a DEFINITY ECS can be administered as itself.
- An 8510T data terminal connected to a DEFINITY G2 or G3 or to a DEFINITY ECS should be aliased as a 7507 with data.

## Button Numbering

The following information can be used to administer the ISDN 8510T voice terminal.

- When the terminal is connected to a DEFINITY G3 or to a DEFINITY ECS, the 10 call appearance/feature buttons should be administered as "BUTTON ASSIGNMENTS" 1 through 10. The Normal feature (the Exit button) should be administered on Button #11.
- When the terminal is connected to a DEFINITY G2, the 10 call appearance/feature buttons should be administered as "BUTTON ASSIGNMENTS" 3 through 12. The Normal feature (the Exit button) should be administered on Button #13.

## The Service Profiler ID (SPID)

---

When ISDN terminals are initially installed, a unique SPID number must be entered into the terminal. This number identifies the terminal to the network. Usually, the system manager provides the SPID for each terminal in the system. Use the following procedure for entering the SPID in an ISDN 8510T terminal.

1. Press **Menu** and then press **Mute**.
2. Dial the numbers, "43" (ID).
3. Press **\*** on the dial pad.
4. Enter digits from the dial pad for a new SPID number. If, at any point, you make a mistake, press **#** to erase the number and re-enter the SPID.
5. When the SPID number is correct, press **\*** on the dial pad to save the new SPID in the terminal.

## Hidden/Craft Features

---

The *ISDN Terminals Installation and Tests Manual*, Issue 3, 555-021-101, contains information on completing the following tasks for the ISDN 8510T voice/data terminal:

- How to enable or disable the listen-only speaker or the speakerphone
- How to enable Selectable Ring Preference
- How to clear all parameters stored in memory
- How to clear a user's password

## 17 ISDN Voice Terminals

### *The ISDN 8510 Voice/Data Terminal*

17-39

- How to set a password known only by the system manager
- How to send or disable Button Number 11

## Power Failure Operation

The 8510T cannot be used as an emergency station during power failure transfer conditions.

## FCC Registration

The 8510T voice/data terminal is FCC registered as a Class A terminal.

## Hearing Aid Compatible

This terminal is compatible with the inductively coupled hearing aids as required by the FCC.

## 8510T Equipment PECs and Comcodes

The 8510T voice/data terminal and optional components can be ordered with the following PECs and Comcodes:

- **ISDN 8510T Voice Terminal**  
PEC: 3117-001 (Black=COL09; White=COL10)  
Comcode: Black=106604382; White=106604390
- **ISDN 8510T Data Terminal**  
PEC: 3117-002 (Black=COL09; White=COL10)  
Comcode: Black=106604424; White=106604432
- **ISDN 8510T TMI Terminal**  
Comcode: Black=106899982; White=106899990
- **Handset**  
PEC: 31149 (Black=COL09; White=COL10)  
Comcode: Black=106050065; White=106053408
- **Handset for Noisy Environments**  
PEC: 31052A (Black=COL09; White=COL10)
- **Handset cord (9 feet)**  
Comcode: Black=105635429; White=105701809
- **Handset cord (12 feet)**  
PEC: 2725-01L (Black=COL09; White=COL10)  
Comcode: Black=102401445; White=104211339
- **Line cord (7 feet)**  
PEC: 2725-07G  
Comcode: 103786778

17 ISDN Voice Terminals

*The ISDN 8510 Voice/Data Terminal*

17-40

- **Designation card**

PEC: 31170

Comcode: 847065467 (package of six 8 1/2" by 11" cards, 67 sheets)

846819530 (package of tractor feed 9 8" by 17" cards, 34 sheets, to be used with LabelMaster)

- **8510 Data Upgrade Kit**

PEC: 32254A

Comcode: 106811979

## Adjuncts

---

The following adjuncts can be used with the 8510T voice/data terminal:

- 500A Headset Adapter (and a standard headset; see "Headsets" below)
- S101A Speakerphone (no longer orderable)
- S201A Speakerphone

## Headsets

A list of compatible headsets, consisting of both modular and plug prong base units and selection of headpieces, appears in "Headset Adapters" in the **Adjuncts** section later in this manual.

## Additional Documents

---

The following documents contain additional information relating to the 8510T voice/data terminal: (Use the 9-digit number listed after each document to order that book from the BCS Publications Center for Lucent Technologies.)

- *ISDN 8510T Voice Terminal User's Manual*, 555-021-736
- *ISDN 8510T Voice Terminal Quick Reference Guide*, 555-021-735
- *ISDN 8510T Voice Terminal Instructions for Changing the Jumper Settings for the Terminating Resistors and for AUX and PHAN Power Options*, 555-021-738
- *ISDN 8510T Voice Terminal Instructions for Installing the Asynchronous Data Board (ADM) or Telephone Multimedia Interface (TMI) Board*, 555-021-754
- *DEFINITY Generic 3 ISDN 8510T Voice Terminal User's Guide*, 555-230-748
- *ISDN 8500 Series Display Terminal ADM User's Manual*, 555-021-730
- *Integrated Services Digital Network (ISDN) Terminals Installation and Tests*, 555-021-101
- *ISDN Application Programming Interface (API) Programmer's Reference Manual*, 533-705-200

# The ISDN 8520T Voice/Data Terminal

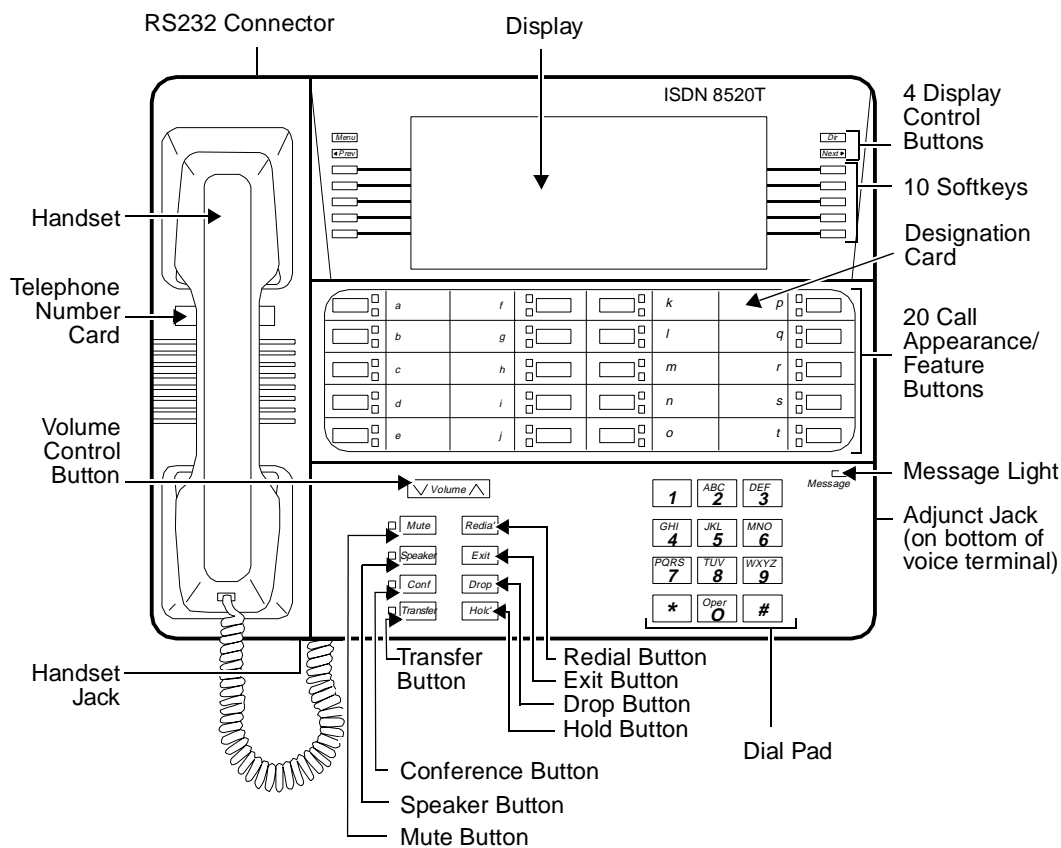

Figure 17-6. The ISDN 8520T Voice/Data Terminal

17 ISDN Voice Terminals

*The ISDN 8520T Voice/Data Terminal*

17-42

The 8520T voice/data terminal is used with the ISDN communication system through a 4-wire "T"-interface. The 8520T voice/data terminal offers the following: 20 call appearance/feature buttons, each with a red and green status light, buttons for the Mute, Redial, Conference, Drop, Transfer, and Hold features (the MUTE, SPEAKER, CONF, and TRANSFER buttons have a red light next to them), a Speakerphone which can also be optioned as a listen-only Speaker, a Volume control, improved acoustic quality with the K-type handset, an Adjunct jack for adjunct equipment, and touch-tone dialing. Ten softkeys and four display control buttons located on either side of the 7-line by 24-character liquid crystal display can be used to access such features as a personal Directory, a Call Log which lists the most recent incoming and outgoing calls, the Self-Test feature, and a personalized ringing pattern for the voice/data terminal.

## Applications

The 8520T voice/data terminal can be used with the DEFINITY Communications System Generic 2 and Generic 3, and the DEFINITY ECS. It can be used as a voice terminal or a data terminal.

## Physical Description

### Dimensions



**NOTE:**

The dimensions given here for the 8520T voice/data terminal are approximate.

Width = 11-1/2 inches

Depth (front to back) = 10-1/4 inches

Height (maximum with handset in place) = 5-3/8 inches

## Features

### Nine Fixed Features

- CONF button
- DROP button
- TRANSFER button
- HOLD button
- MUTE button
- SPEAKER button
- EXIT button
- REDIAL button
- VOLUME button

### Message Light

The red Message light goes on when a message is left for the user. This light goes off when the user retrieves the message.

### Call Appearance/Feature buttons

These 20 buttons are devoted *either* to handling incoming and outgoing calls (call appearances) and are labeled with the exchange (numbers) and extension number *or* they can be used as feature buttons to access voice features such as Call Forward or Send All Calls; these are labeled with the feature name. Each of these 20 call appearance/feature buttons has a red light, which indicates the selected line, and a green light which indicates the status of that line or feature.

### REDIAL button

With the Redial feature, the user can redial the telephone number last dialed from the dial pad. (The handset must be off-hook, or the speaker must be active.) Up to 37 digits can be redialed.

### Speakerphone (Listen and Speak) Feature

The 8520T voice/data terminal is equipped with a built-in S201A-type speakerphone. The Speakerphone capability allows a user to engage in a hands-free 2-way conversation with the far-end party. The speakerphone can be turned off or on with the SPEAKER button; it can be muted with the MUTE button, and the volume can be controlled with the VOLUME “arrow” button.

With the softkeys, the user can adjust the speakerphone for optimal performance. The user hears a set of tones as the speakerphone performs an acoustic test of the environment. When the tones stop, the speakerphone has finished adjusting itself and is ready for use. The user should reset the speakerphone whenever the voice/data terminal (or the table or desk on which the terminal is situated) is moved to another place (even in the same room).

## Speaker (Listen-only) Feature

The 8520T voice/data terminal can be optioned for the Speakerphone (listen and speak) or the Speaker (listen-only) feature. (The terminal is shipped with the Speakerphone setting in place.)

The Speaker (listen-only) capability allows a user to engage in a one-way conversation with the far-end. The user can only listen to the far-end; the user is not able to transmit his voice over the speaker. Use the SPEAKER button on the front of the terminal for turning on and off the speaker or speakerphone. To speak with the far-end, the user must use the handset. Lifting the handset turns off the speaker.

## MUTE button

While on a call, the user can press the MUTE button (the red light next to the button goes on), so the user can converse with someone in the same room without the other party hearing the conversation. The user is placed in listen-only mode. To disable the feature, the user presses the MUTE button a second time (the red light goes off). The Mute function works only with the speakerphone and the handset.

## EXIT button

The EXIT button is used for exiting a softkey feature and returning to the user-selected Home Screen. The top two lines again show you the time and date and any relevant system information.

## VOLUME control button

When the user is on a call using the speakerphone, the VOLUME "arrow" button raises or lowers the volume on the speakerphone. Likewise, when the user is on a call using the handset, the VOLUME control button changes the receive level of the handset. When the handset is on-hook and the speakerphone is off, this button raises or lowers the ringer volume or tones such as the confirmation or error tone.

## Softkeys

The 10 unlabeled buttons located on both sides of the display correspond to words on the display screen. Softkeys are used along with display control keys to access the following features:

- Setting the clock
- Setting the speakerphone
- Adding, editing, and deleting the numbers and associated names (and optional group names) in the voice terminal Directory
- Organizing your Directory in alphabetical order or by group name, renaming a group, and moving Directory entries from one group into another



17 ISDN Voice Terminals

*The ISDN 8520T Voice/Data Terminal*

17-45

- Searching the Directory for a particular entry, by name or by number, and then placing a call to the number currently shown on the display screen
- Viewing the contents of your Directory, and then editing, deleting, or placing a call to the number currently shown on the display screen
- Using **Dir** to quickly place a call to a number located in your Directory
- Using the Call Log to view incoming and/or outgoing calls
- Choosing to display an indicator when new calls are logged
- Locking and unlocking any Directory Changes, the Call Log, and all Softkey functions
- Changing or removing your password
- Selecting a home screen, which your display will return to whenever you press **Exit**
- Initiating a self-test of the voice/data terminal's lights, ringer, buttons, and display
- Selecting the contrast level for the display
- Selecting a personalized ringing pattern
- Selecting the type of display messages shown on the display screen (all messages or only error messages) and setting the rate at which the display messages are shown
- Adding confirmation or error tones to display messages
- Setting the number of names on a Directory page
- Providing Service Information if the terminal is used for data functions
- Choosing if and when the speaker becomes active while placing a voice call using your PC

### Display control buttons

These four buttons are labeled **Menu**, **Dir**, **◀ Prev**, and **Next ▶**.

- **Menu** is used to access the main softkey menu.
- **Dir** allows you to quickly access Directory entries in order to place a call.
- **◀ Prev** and **Next ▶** can be used to help you go back and forth through menu options, to add, edit, or search for an entry in your Directory, and to view entries in your Call Log.

17 ISDN Voice Terminals

*The ISDN 8520T Voice/Data Terminal*

17-46

## Other Physical Features

### Handset

The 8520T voice/data terminal is equipped with a K-type handset.

A K-type Noisy Environment Handset (PEC: 31052A) can also be purchased and connected to the 8520T terminal.

### Dial pad

The 8520T is equipped with a standard 12-button touch-tone dial pad for dialing telephone numbers or accessing features. The letters "Q" and "Z" have been added to the appropriate dial pad keys for directory access, and the "5" button on your dial pad has raised bars for visually-impaired users.

### Ringling

The 8520T has electronic tone ringing with eight possible personalized ringing patterns that can be selected through the softkeys and the display control buttons. Ringer volume is controlled by the VOLUME "arrow" button when the terminal is on-hook.

### Jacks

The 8520T housing contains three jacks. The Handset cord jack, for connecting the handset to the voice/data terminal, is located on the bottom of the housing, near the front of the terminal. The Line jack, for connecting the line cord to the 8520T, is located on the bottom (left center) of the set. The Adjunct jack, which is located on the bottom of the set directly below the Line jack, is used for connecting optional adjunct equipment such as an S201A Speakerphone or a 500A Headset Adapter to the voice/data terminal.

The RS232 jack on the rear of the set can be used for connecting data equipment.

### Cords

Two cords are supplied with the 8520T voice/data terminal: a coiled 9-foot modular Handset cord and a 7-foot Line cord. An optional 12-foot Handset cord is available.

### Mounting Options

The 8520T comes equipped with a desk stand. This voice/data terminal cannot be wall-mounted.

### Color Options

The 8520T is available in black or white.

17 ISDN Voice Terminals

*The ISDN 8520T Voice/Data Terminal*

17-47

## Data Features

---

The ISDN 8520T voice terminal has the following data features:

- Asynchronous full-duplex operation at data rates from 1200 bits per second (bps) to 57.6 kilobits per second (kbps) through an EIA-232 interface.
- X.25 packet switched data communication including receipt of X.29 commands from a remote X.25 host for setting packet switched data parameters.
- Circuit switched data communication over 56 or 64 kbps facilities via industry standard V.120 rate adaption protocol.
- Circuit switched data communication over 64 kbps facilities via Lucent Technologies' Digital Multiplexed Interface Mode 2 or Mode 3 rate adaption protocols.
- API allows a PC to control all aspects of the set's interaction with the user and with the network.
- The 10 softkeys and four display control buttons located to the left and right of the liquid crystal display can be used to access data features such as view current options, change options, answer a data call, place a data call, reset a locked data set, and selecting to display a data indicator. Note, the first two lines of the 7-line display contain switch information; the remaining five lines contain softkey information.
- A user-friendly command interface with on-screen help, nine programmable named data memory numbers, and four programmable data option profiles.
- An expanded Hayes AT command set interface for compatibility with applications which require this command format.
- Remote and local loopback tests.

For more information about the data features on an 8500-Series terminal, see the *ISDN 8500 Series Display Terminal ADM User's Manual*, 555-021-730.

## Distance Limitations

---

For the DEFINITY G2 and G3 and the DEFINITY ECS, in which multipoint configuration is used, the maximum signaling distance possible from the port board to the work location jack is: (The terminating resistor should be within 250 feet of the work location; the distances listed are applicable for up to two voice/data terminals.)

- If 24 AWG cable is used = 1600 feet
- If 26 AWG cable is used = 1330 feet

17 ISDN Voice Terminals

The ISDN 8520T Voice/Data Terminal

17-48

## Power Requirements

---

### Auxiliary Power Supply

The 8520T needs auxiliary power from an auxiliary power supply. Recommended power supplies are the 1151A1 and 1151A2 with Battery Holdover and MSP-1 (local) Power Supplies and the 1145A and 1145B1 Bulk Power Supplies.

### Terminating Resistor

The terminating resistor setting must be set by either a service representative or the system administrator.

- The terminating resistor setting should be set to OUT when the voice/data terminal is in a point-to-point configuration and the terminating resistor is in the closet.
- The terminating resistor setting on the terminal should be set to IN when the voice/data terminal is in a point-to-point configuration and the terminating resistor is *not* in the closet.
- When terminals are part of a multipoint configuration and the terminating resistor is in the closet, all sets should be set to OUT.
- When the terminating resistor is *not* in the closet and the terminals are part of a multipoint configuration, only one of the sets in this configuration needs to be set to IN. All the rest of the sets in this configuration should be set to OUT.

To change the terminating resistor setting, do the following:

1. Press **Menu** and then **Mute** .
2. Dial the numbers "87" (TR).
3. The display screen shows you the current terminating resistor setting (IN or OUT). Use the softkeys to toggle between the two settings, whichever is correct for that terminal.
4. When the correct setting is shown on the display screen, press the softkey beside **Done**.

### Switch Administration

---

An 8520T voice/data terminal connected to a DEFINITY G2, G3i, G3r, or to a DEFINITY ECS, should be aliased as a 7507 with data.

## 17 ISDN Voice Terminals

*The ISDN 8520T Voice/Data Terminal*

17-49

## Button Numbering

The ISDN 8520T voice terminal must be administered in the following ways:

- When the terminal is connected to a DEFINITY G3 or a DEFINITY ECS, the 20 call appearance/feature buttons should be administered as "BUTTON ASSIGNMENTS" 1 through 20.

**NOTE:**

On a DEFINITY G3 or a DEFINITY ECS, the Normal or Exit feature should be administered on Button #21.

- When the terminal is connected to a DEFINITY G2, the call appearance/feature buttons should be administered as "BUTTON ASSIGNMENTS" 3 through 22.

## The Service Profiler ID (SPID)

---

When ISDN terminals are initially installed, a unique SPID number must be entered into the terminal. This number identifies the terminal to the network. Usually, the system manager provides the SPID for each terminal in the system. Use the following procedure for entering the SPID in an ISDN 8520T terminal.

1. Press **Menu** and then press **Mute**.
2. Dial the numbers, "43" (ID).
3. Press **\*** on the dial pad.
4. Enter digits from the dial pad for a new SPID number. If, at any point, you make a mistake, press **\*** to erase the number and re-enter the SPID.
5. When the SPID number is correct, press **#** on the dial pad to save the new SPID in the terminal.

## Hidden/Craft Features

---

For information on the hidden or craft features, those features that can be done only by qualified service personnel, use the procedures listed for the 8510T terminal in the *ISDN Terminals Installation and Tests Manual*, Issue 3, 555-021-101. The section titled **ISDN 8500-Series T-Interface Terminals** in that manual contains information on completing the following tasks for the ISDN 8510T voice/data terminal (the procedures for these tasks can also be used for the 8520T):

- How to enable or disable the listen-only speaker or the speakerphone
- How to enable Selectable Ring Preference
- How to clear all parameters stored in memory
- How to clear a user's password

## 17 ISDN Voice Terminals

*The ISDN 8520T Voice/Data Terminal*

17-50

- How to clear a password known by the system administrator
- How to send or disable Button Number 11

## Power Failure Operation

The 8520T cannot be used as an emergency station during power failure transfer conditions.

## FCC Registration

The 8520T voice/data terminal is FCC registered as a Class A terminal.

## Hearing Aid Compatible

This voice/data terminal is compatible with the inductively coupled hearing aids as required by the FCC.

## 8520T Equipment PECs and Comcodes

The 8520T voice/data terminal and optional components can be ordered with the following PECs and Comcodes:

- **ISDN 8520T Voice Terminal**  
PEC: 3116-001 (Black=COL09; White=COL10)  
Comcode: Black=106906431; White=106906449
- **Handset**  
PEC: 31149 (Black=COL09; White=COL10)  
Comcode: Black=106050065; White=106053408
- **Handset for Noisy Environments**  
PEC: 31052A (Black=COL09; White=COL10)
- **Handset cord (9 feet)**  
Comcode: Black=105635429; White=105701809
- **Handset cord (12 feet)**  
PEC: 2725-01L (Black=COL09; White=COL10)  
Comcode: Black=102401445; White=104211339
- **Line cord (7 feet)**  
PEC: 2725-07G  
Comcode: 103786778
- **Designation cards**  
6 sheets (each sheet has enough designation cards for 6 sets)  
Comcode: 847244274  
18 sheets (each sheet has enough designation cards for 6 sets)

17 ISDN Voice Terminals

*The ISDN 8520T Voice/Data Terminal*

17-51

Comcode: 847244282

68 sheets (each sheet has enough designation cards for 6 sets)

Comcode: 847244290

## Adjuncts

---

The following adjuncts can be used with the 8520T terminal:

- 500A Headset Adapter (and a standard headset; see "Headsets" below)
- S101A Speakerphone (no longer orderable)
- S201A Speakerphone

## Headsets

A list of compatible headsets, consisting of both modular and plug prong base units and selection of headpieces, appears in "Headset Adapters" in the **Adjuncts** section later in this manual.

## Additional Documents

---

The following documents contain additional information relating to the 8520T voice/data terminal: (Use the 9-digit number listed after each document to order that book from the BCS Publications Center for Lucent Technologies.)

- *ISDN 8520T Voice Terminal User's Manual*, 555-021-758
- *DEFINITY Generic 3 ISDN 8520T Voice Terminal User's Guide*, 555-230-767
- *ISDN 8500 Series Display Terminal ADM User's Manual*, 555-021-730
- *ISDN Application Programming Interface (API) Programmer's Reference Manual*, 533-705-200

**17 ISDN Voice Terminals**

*The ISDN 8520T Voice/Data Terminal*

17-52



## Cordless and Wireless Telephones

# 18

---

The following cordless and wireless telephones are described in this section:

- The MDC 9000 Cordless Telephone
- The MDW 9000 Wireless Telephone
- The MDW 9031DCP Wireless Pocket Phone, both the single-zone and the dual-zone models

## The MDC 9000 Cordless Telephone

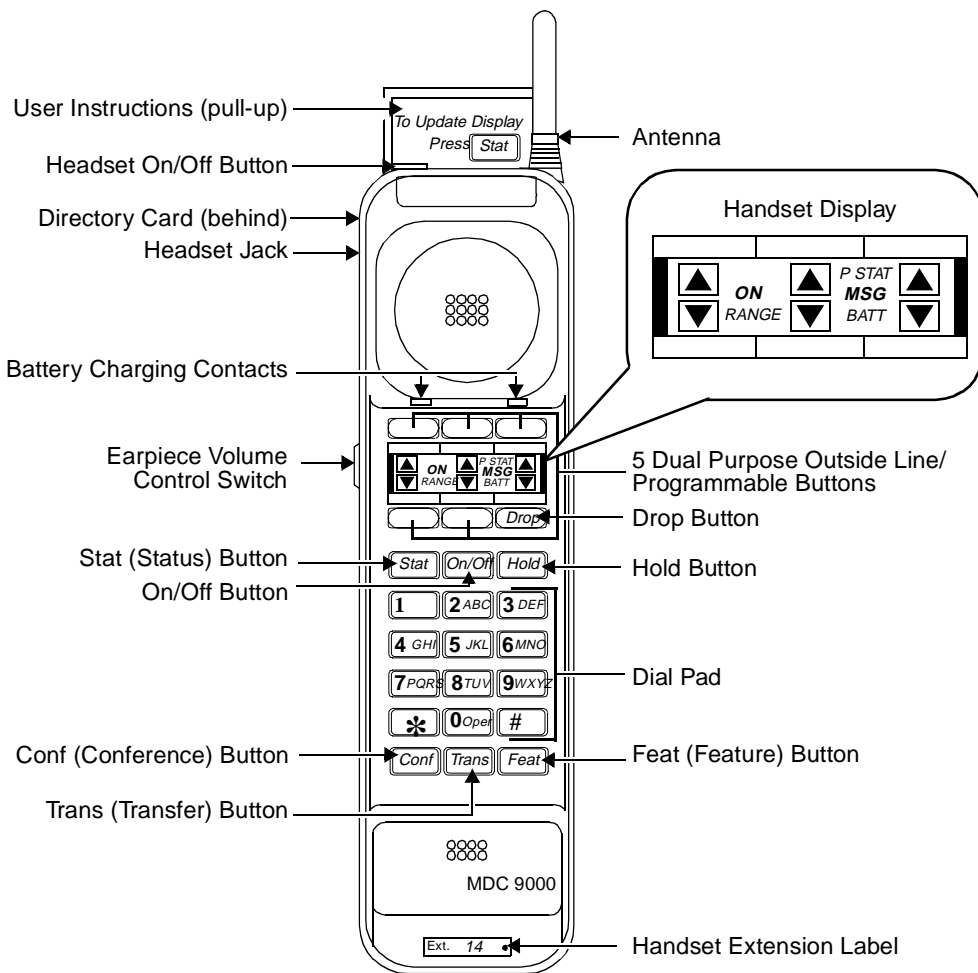

Figure 18-1. The MDC 9000 Telephone, Top View of Handset, Including Enlarged Display Area

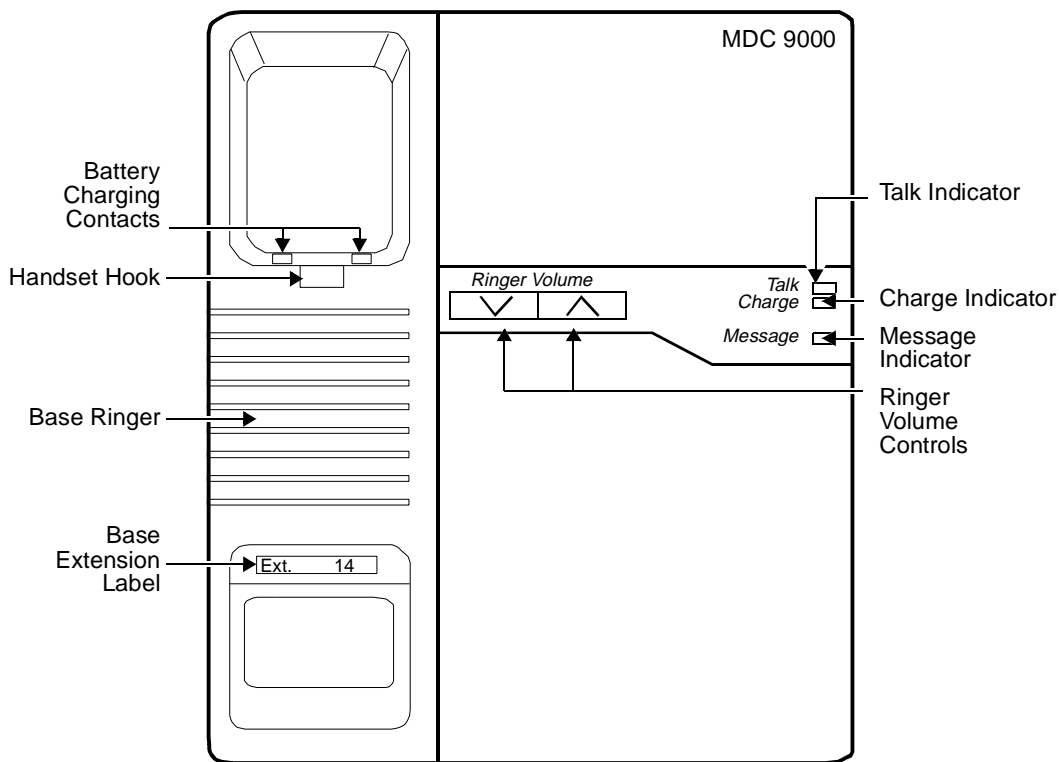

Figure 18-2. The MDC 9000 Telephone, Top View of Charging Base

The MDC 9000 Cordless Telephone has two basic parts, the handset and the charging base.

- The handset has line/programmable feature/intercom buttons, Conference, Drop, Hold, Transfer, Status, and Feature buttons, Headset On/Off and Handset On/Off buttons, a LCD display, an earpiece volume control switch, battery charging contacts, a directory card, and a headset jack.
- The charging base has a handset hook, ringer volume controls, battery charging contacts, a Talk indicator, a Charge indicator, a Message indicator, and a base ringer.

In order to provide you with the freedom of mobility, the MDC 9000 is not connected physically (by a line cord or wire from the handset) to the DEFINITY Communications System Generic 1, Generic 2, or Generic 3, a DEFINITY Enterprise Communications Server (ECS), System 75, or System 85. Instead, the MDC 9000 handset communicates by way of a radio link to its radio base, which connects to the telephone system.

## Applications

---

The MDC 9000 Cordless Telephone can be used with the DEFINITY Communications System Generic 1, Generic 2, and Generic 3, the DEFINITY ECS, System 75, and System 85.

## Physical Features

---

### Dimensions



**NOTE:**

The dimensions described here for the MDC 9000 handset and charging base are approximate.

#### **For the Handset:**

Width = 2.44 inches

Length = 12.1 inches

Height = 2.3 inches

#### **For the Charging Base:**

Width = 7.52 inches

Length = 9.4 inches

Height = 3.43 inches

## Handset Features

### **Fixed Feature Buttons**

The MDC 9000 has the following eight fixed feature buttons:

- CONFERENCE button — labeled CONF
- DROP button — The DROP button is NOT labeled. It is located in the lower right corner of the LCD display.
- TRANSFER button — labeled TRANS
- HOLD button
- FEATURE button — The Feature button (labeled FEAT) is not used.

**18** Cordless and Wireless Telephones  
*The MDC 9000 Cordless Telephone*

18-5

- **STATUS button** — The Status button (labeled STAT) is used to update all handset visuals if pressed when the STAT indicator appears (the handset is on), and to turn on the display when the handset is off.
- **Headset On/Off button** — This button is used for turning the headset on and off.
- **Handset (labeled ON/OFF) button** — This button is used for turning the handset on and off. (This button can also turn the headset on and off.)

### **Outside Line or Intercom/ Programmable Feature Buttons**

When labeled with an extension number, these buttons indicate lines used for incoming and outgoing calls (call appearances) and for using the telephone as an intercom; when programmed and labeled with feature names, these buttons access features (feature buttons). In use, the light next to that button is lit; when a call is on hold, it winks.

### **LCD Display**

The display provides information on line status, whether the telephone is out of range, whether the battery is low, if you have a message, and when you are in program mode.

### **Dial Pad**

The telephone has a standard 12-button pad for dialing telephone numbers and accessing features.

### **Directory Card**

The set has a directory card for writing or typing names of frequently dialed telephone numbers or extensions. It is located on the bottom of the handset cover.

### **User Instructions**

The set also provides you with a quick reference that you can pull up to review basic procedures for using this telephone's features.

### **Antenna**

The antenna is used for receiving the transmissions from the radio module. This antenna is flexible and is permanently attached to the handset.

### **Earpiece Volume Control Switch**

This volume control is used for sliding between the two earpiece volume control positions, Normal and High.

### **Battery Charging Contacts**

The contacts are used for charging the handset when contact is made with the charging base.

## Headset Jack

This jack is used for connecting the headset to the handset.

## Charging Base Features

### Talk Indicator

This indicator is lit when the handset is off-hook. (The **ON** icon on the handset is also lit.)

### Charge Indicator

This indicator is lit when the battery is charging and the handset is properly placed on the base.

### Message Indicator

This indicator is lit when you have a message. (**MSG** also appears on the handset display.)

### Ringer Volume Controls

This volume control is used for adjusting the base's ringing volume. Press the left button to decrease the ringer volume; press the right button to increase the ringer volume.



#### NOTE:

When the handset is on the base, only the base rings. Both ring when the handset is out of the base.

### Base Ringer

This is the ringer located in the base.

### Handset Hook

This hook is used for hanging up the handset in the base.

### Battery Charging Contacts

These charging contacts are used for charging the handset when contact is made with the charging base.



### Power Cord Jack

This jack is used for connecting the power cord to your telephone. This cord is then plugged into a wall outlet. This jack is located on the other side of the base.

## Display Information

---

The telephone display provides visual call and telephone status information through the following set of icons:

-  or  or  shows the status of the adjacent button. If the triangle and rectangle both appear, you are using that line; if only the rectangle appears, the line is in use.
- **ON** appears when the handset is on.
- **RANGE** flashes to indicate that you are out of range and appears steadily when you have lost communication.
- **P** is *not* used with a DEFINITY switch or System 75 or System 85.
- **STAT** appears when the status mode is active, refreshing the icons and indicating that you should move closer to the base.
- **MSG** appears when there is a message waiting for you.
- **BATT** appears when the battery is low.

## Out-of-Range Indication

---

While the set is still active, it gives an audible indication (double beep) and visual indication (the **RANGE** icon appears on the LCD display) when the handset is getting out of range.

## Distance and Installation Limitations (for the Charging Base)

---

The MDC 9000 uses radio transmissions to communicate. The range depends on your particular operating environment, and the range can be improved by placing the base in an optimum location. The base can be placed on a desk or mounted on a wall.

Before you install the phone, note the following considerations:

- Mount the base near the center of the area in which the handset will be used, but at least 20 feet away from the phone system switch.
- Install the base within 6 feet of a properly grounded 3-prong electrical outlet that is not controlled by an on/off switch.
- If your phone system uses an uninterruptible power supply, such as a backup generator, be sure to connect the base for the cordless phone to that power supply.
- The base should not share the same power line or be within 6 feet of equipment with microprocessors such as answering machines, personal computers, and fax machines, 900 MHz wireless LANS and other

**18** Cordless and Wireless Telephones  
*The MDC 9000 Cordless Telephone*

18-8

equipment, phone system control units, uninterruptible power supplies, copier machines or electric motors and industrial machinery. A distance of 20 feet is advisable for minimum interference.

- The base should be located at least 3 feet from metal sources. These include metal reinforced ceilings, metal window frames, concrete reinforced with metal, sheet metal walls, steel 1-beams, metal studs in walls, screens, and fences.
- Some solid structures, such as moist concrete walls, brick walls, and steel reinforced concrete walls, will inhibit the range.
- If more than one cordless phone is being used, do not place a handset from one cordless phone into the base of another. If this accidentally occurs, place each handset in the correct base for at least 10 seconds.

## Switch Administration

### Aliasing

For all System 75, System 85, DEFINITY Generic 1, and Generic 2 switches, and DEFINITY Generic 3, Versions 1 and 2, the MDC 9000 terminal must be administered as a 7303S Hybrid terminal.

Beginning with the DEFINITY Generic 3, Version 3 (or later), the MDC 9000 can be administered as itself.

For the System 85, R2V1 through R2V4 switch which does not accommodate Universal modules, an ANN17B Hybrid pack in conjunction with a DS-1 carrier must be used to connect the switch and the MDC 9000 terminal. On all other switches, including System 75, DEFINITY Generic 1, Generic 2, and Generic 3, and the DEFINITY ECS, a TN62B Hybrid pack must be used with the Universal carrier for this purpose.

#### NOTE:

A DEFINITY Generic 2 may use either an ANN17B or a TN62B pack. In either case, the latest vintage packs are recommended.

### Button Numbering

Only the system manager should administer feature button assignments on the telephone. It is recommended that you not use a feature that requires visuals (that is, the light next to each administrable button) to be updated while the set is turned off, or any feature that may be activated by button depression while the set is turned off (for example, Send All Calls).

Use Figure 18-3 for button numbering on the MDC 9000 set when it is connected to a System 75, a DEFINITY Generic 1 or Generic 3, or to a DEFINITY ECS. Use



Figure 18-4 for button numbering on the MDC 9000 set when it is connected to a System 85 or a DEFINITY Generic 2.



**NOTE:**

On System 75, the DEFINITY Generic 1 and Generic 3, or a DEFINITY ECS, button numbering begins with "1," the button on the upper right of the display. On System 85 and the DEFINITY Generic 2, button numbering starts with "3."

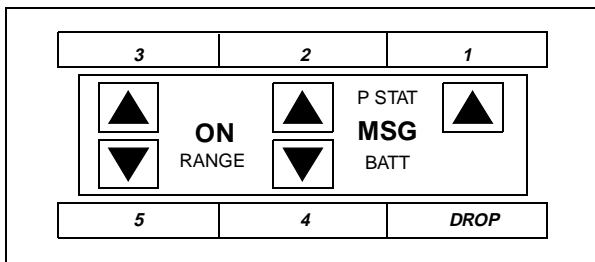

Figure 18-3. Button Numbering for a MDC 9000 Connected to System 75, a DEFINITY Generic 1 or Generic 3, or a DEFINITY ECS

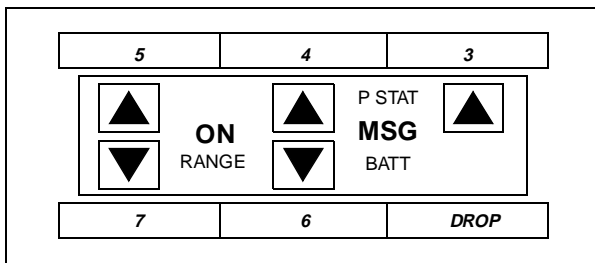

Figure 18-4. Button Numbering for a MDC 9000 Connected to System 85 or a DEFINITY Generic 2

**18** Cordless and Wireless Telephones  
*The MDC 9000 Cordless Telephone*

18-10

## FCC Registration

The MDC 9000 telephone has been tested and has been found to comply with FCC Part 15 Rules.

## Hearing Aid Compatibility

The MDC 9000 telephone is compatible with inductively-coupled hearing aids.

## MDC 9000 Equipment PECs and Comcodes

The MDC 9000 Telephone and components can be ordered with these PECs and Comcodes:

- **MDC 9000 Telephone**
  - Black Set = PEC: 3203-03B
  - Comcode: 106738073;
  - White Set = PEC: 3203-03W
  - Comcode: 106739089
- **Headset**
  - PEC: 3122-041
- **Battery Pack**
  - Black PEC: 32036
  - Comcode: 106760804
  - White PEC: 32034
  - Comcode: 106760812
- **Holster**
  - Gray
  - Comcode: 846628527
  - Black
  - Comcode: 846501401
- **Line Cord**
  - 14-foot (From Lucent Technologies Catalog Sales) 10095X
  - (From Lucent Technologies National Parts Sales Center) 32008A
  - 25-foot (From Lucent Technologies Catalog Sales) 10096X
  - (From Lucent Technologies National Parts Sales Center) 32009A
  - 50-foot (From Lucent Technologies Catalog Sales) 10097X
  - (From Lucent Technologies National Parts Sales Center) 32010A
  - 75-foot (From Lucent Technologies Catalog Sales) 10098X
  - (From Lucent Technologies National Parts Sales Center) 32900A
  - 100-foot (From Lucent Technologies Catalog Sales) 10094X
  - (From Lucent Technologies National Parts Sales Center) 32011A
- **Supra RF Headset**
  - PEC: 32030

**18** Cordless and Wireless Telephones  
*The MDC 9000 Cordless Telephone*

18-11

## **Additional Documents**

---

The following documents contains additional information relating to the MDC 9000 Cordless Telephone: (Use the 9 digit number listed after each document to order that book from the BCS Publications Center for Lucent Technologies.)

- *DEFINITY Generic 1, 2, and 3, System 75 and System 85 MDC 9000 Cordless Telephone User's Guide, 555-230-769*
- *MDC 9000 Cordless Business Telephone Installation Manual, 503-801-101*

## The MDW 9000 Wireless Telephone

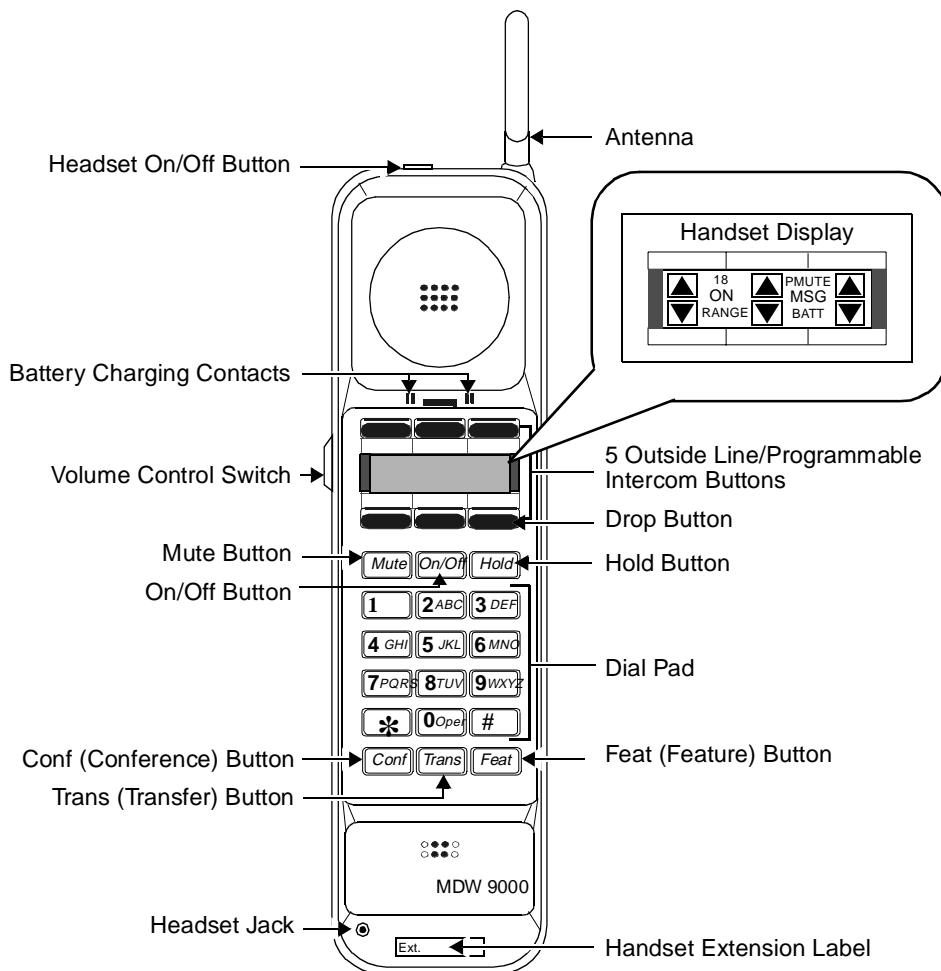

Figure 18-5. The MDW 9000 Telephone, Including Enlarged Display Area

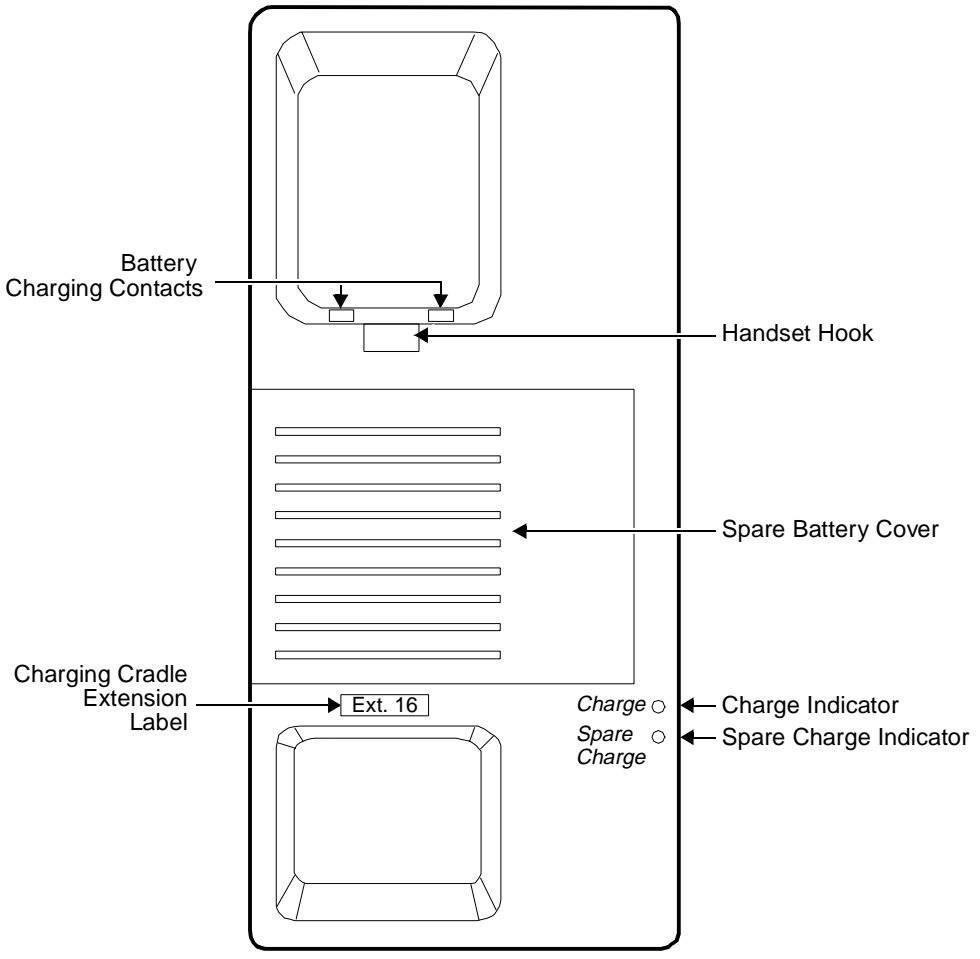

Figure 18-6. The MDW 9000 Telephone, Top View of Charging Cradle

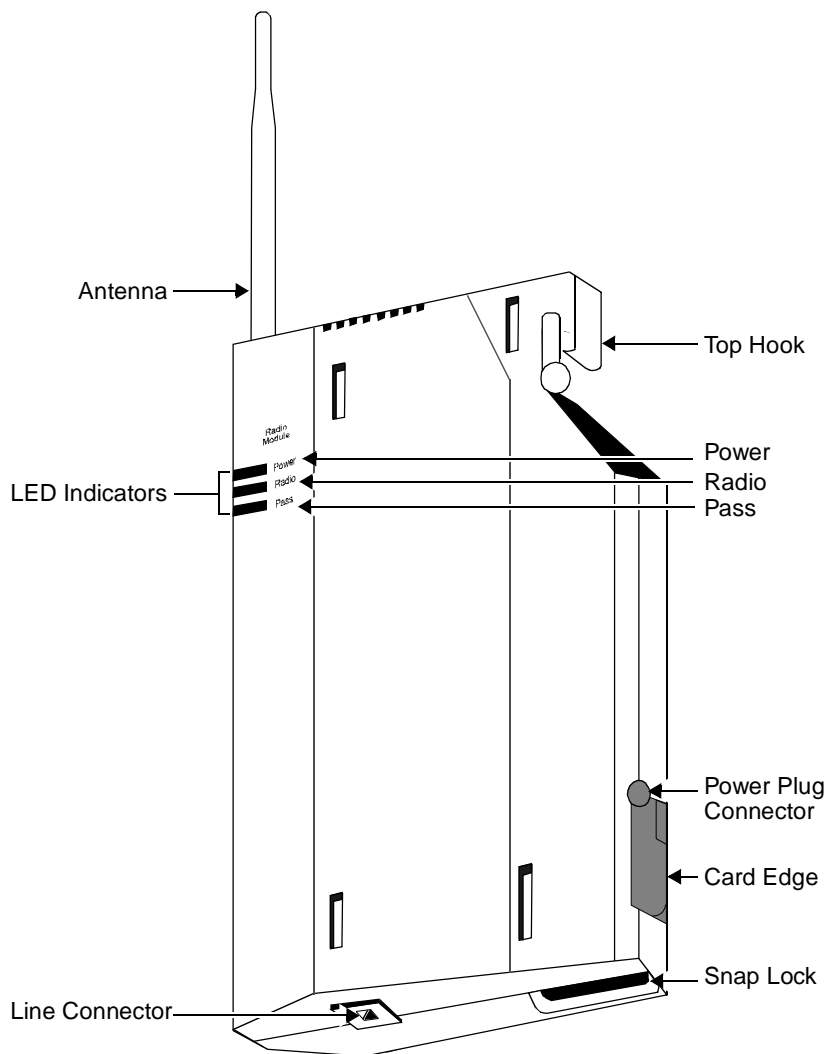

Figure 18-7. The MDW 9000 Telephone, Radio Module

The MDW 9000 Wireless Telephone is part of the TransTalk™ 9000 Digital Wireless System family of telephones. This wireless telephone has three basic parts, the handset the charging cradle, and the radio module.

- The handset has line/programmable feature/intercom buttons, Drop, Mute, Hold, Conference, and Transfer buttons, a Headset On/Off button and a Handset On/Off button, a LCD display, a Volume control switch, battery charging contacts, a flexible antenna, and a Headset jack.
- The charging cradle has a handset hook, a spare battery cover, a spare battery.

**18** Cordless and Wireless Telephones  
*The MDW 9000 Wireless Telephone*

18-15

- The radio module has Power, Pass, and Radio indicator lights, a top hook, card edge, and snap lock which connect the radio module to the carrier assembly/backplane, an antenna, and power plug and line connectors.

In order to provide you with the freedom of mobility, the MDW 9000 is not connected physically (by a line cord or wire from the handset) to the DEFINITY Communications System Generic 1, Generic 2, or Generic 3, or the DEFINITY ECS. Instead, the MDW 9000 communicates by way of a radio link to its matched radio module, which, in turn, connects it to the DEFINITY switch or the DEFINITY ECS. The telephone needs merely an electrical outlet, and a test check to make sure that the handset is in range of its matching radio module.

The handset communicates through a matching radio module. When up to six wireless phones are used within a single location, a carrier assembly is required. When the radio modules are placed in the carrier assembly, it is considered a radio base station.

## Applications

---

The MDW 9000 Wireless Telephone can be used with the DEFINITY Communications System Generic 1, Generic 2, and Generic 3, the DEFINITY ECS, System 75, and System 85.

## Physical Features

---

### Dimensions



**NOTE:**

The dimensions described here for the MDW 9000 telephone are approximate.

**For the Handset:**

Width = 1.5 inches

Length = 10 inches

Height = 2.43 inches

**For the Cradle:**

Width = 3.94 inches

Length = 9.75 inches

Height = 5.13 inches

### For the Radio Module:

Width = 5.5 inches

Length = 12.1 inches

Height = 1.5 inches

## Handset Features

### Fixed Feature Buttons

The MDW 9000 has the following eight fixed feature buttons:

- CONFERENCE button — labeled CONF
- DROP button — The DROP button is NOT labeled. It is located in the lower right corner of the LCD display.
- TRANSFER button — labeled TRANS
- HOLD button
- FEATURE button — The Feature button (labeled FEAT) is not used.
- MUTE button — The MUTE button is used to turn on and off the microphone associated with the handset *or* the headset.
- Headset On/Off button — This button is used for turning the headset on and off. Located on top of the handset, it is used when the headset jack is in use. At all other times, the Headset On/Off button is deactivated to prevent accidental call termination.
- Handset (labeled ON/OFF) button — This On/Off button is used for turning the handset on and off. (It can also be used to turn the headset on or off.)

### Outside Line or Intercom/ Programmable Feature Buttons

When labeled with an extension number, these buttons indicate lines used for incoming and outgoing calls (call appearances) and for using the telephone as an intercom; when programmed and labeled with feature names, these buttons access features (feature buttons).

### LCD Display

The display provides information on the status of lines and range, battery power, mute usage, etc. (See “Display Information” later in this section.)

### Dial Pad

This is the standard 12-button pad for dialing telephone numbers and accessing features.



### **Volume Control Switch**

The Volume control adjusts the receiver volume (higher or lower) when the handset is off-hook and adjusts the ring volume (higher or lower) when the handset is on-hook.

### **Antenna**

The antenna is used for receiving the transmissions from the radio module. This antenna is flexible and is permanently attached to the handset.

### **Battery Charging Contacts**

These contacts are used for charging the handset when contact is made with the charging cradle.

### **Headset Jack**

This jack is used for connecting the headset to the handset.

## **Charging Cradle Features**

### **Charge Indicator**

The green Charging Indicator light on the cradle's faceplate indicates when the handset battery is charging. This LED is labeled **Charge**.

### **Spare Charge Indicator**

The green Charge Indicator light on the cradle's faceplate indicates when the spare battery (in the spare battery garage) is charging. This LED is labeled **Spare Charge**.

### **Battery Charging Contacts**

The battery charging contacts are used for charging the handset when contact is made with the charging cradle.

### **Handset Hook**

This hook is used for hanging up the handset in the cradle.

### **Spare Battery Cover**

The battery cover covers the spare battery garage. It opens by sliding to the left.

### **Modular Power Pack**

This rechargeable, replaceable battery pack provides at least 3 hours of "talk time" and should hold its charge for at least 22 hours. The power pack is located inside the cradle.

## Power Cord Jack

This jack is used for connecting the power cord to your charging cradle. This cord is then plugged into a wall outlet. This jack is located on the back of the cradle.

## Radio Module Features

### Power and Pass Indicator Lights

The Power and Pass lights indicate when the module is powered up and completes its self-diagnostic. The Radio light goes on when the handset is in use.

### Top Hook and Card Edge

The top hook and the card edge connect the radio module to the carrier assembly/backplane mounting rod.

### Snap Lock

This lock locks the radio module into the carrier assembly.

### Antenna

The sturdy and flexible antenna sends signals between the handset and the radio module.

### Power Plug Jack



The AC adapter should be inserted into this jack.

### Line Jack

The line cord should be inserted into this jack.

## Display Information

The LCD Display provides visual call and telephone status information through the following set of icons:

-  or  or  shows the status of the adjacent button. If the triangle and rectangle both appear, you are using that line; if only the rectangle appears, the line is in use.
- **18** appears during Local Test Mode; **0** through **10** can appear during the Wireless Test Mode.
- **ON** appears when the handset is on.
- **RANGE** flashes to indicate that you are out of range and appears steadily when you have lost communication.
- **P** is *not* used with a DEFINITY switch or System 75 or System 85.
- **MUTE** appears when the handset microphone is muted.

- **T** appears when the Wireless Test Mode is active.
- **MSG** appears when there is a message waiting for you.
- **BATT** appears when the battery is low.

## Out-of-Range Indication

While the set is still active, it gives an audible indication (double beep) and visual indication (the **RANGE** icon appears on the LCD display) when the handset is getting out of range of the radio module.

## Distance and Installation Limitations

The MDW 9000 uses radio transmissions to communicate. The range depends on your particular operating environment. For indoor use, intervening walls will reduce the phone's range. Try to stay away from concentrations of structural metal, such as steel and aluminum, or reinforced concrete.

At least 6 feet is required between the radio module/radio base station and the phone system switch.

Before you install the radio module or radio base station, note the following considerations:

- When positioning the radio module or radio base station, try to place the unit in a central location, relative to the handset usage area. If your switch is located in a distant area, you may have to run line cord from your phone system to the centrally positioned radio module(s). The maximum distance is 1000 feet of 26 gauge cable.
- The radio module or radio base station should not share the same power line or be within 6 feet of equipment with microprocessors such as answering machines, personal computers, and fax machines, or electromagnetic equipment such as electric motors.
- For remote locations, an individual radio module can be installed in that area and attached via line cord to the phone system. IROBs should be used in outdoor area.
- The radio module or radio base station should be placed high on the wall for optimum voice quality and range. Allow at least 1 foot of space between the top of the antenna on the radio module(s) and the ceiling.
- Install the single radio module within 3 feet of either side of, and within 6-8 feet above, a properly grounded 3-prong electrical outlet that is not controlled by an on/off switch.
- Install the radio base stations within 15 feet of either side of, and within 6-8 feet above, a properly grounded 3-prong electrical outlet that is not controlled by an on/off switch.

**18** Cordless and Wireless Telephones  
*The MDW 9000 Wireless Telephone*

18-20

- If your phone system uses an uninterruptible power supply, such as a backup generator, be sure to connect the radio or radio base station to that power supply.

## Switch Administration

---

### Aliasing

For all System 75 and System 85 releases and DEFINITY Generic 1, Generic 2, and Generic 3, Versions 1 and 2, the MDW 9000 terminal must be administered as a 7303S Hybrid terminal.

If your MDW 9000 is connected to a DEFINITY Generic 3, Version 3 (or later), the MDW 9000 can be administered as itself.

For the System 85, R2V1 through R2V4 switch which does not accommodate Universal modules, an ANN17B Hybrid pack in conjunction with a DS-1 carrier must be used to connect the switch and the MDW 9000 terminal. On all other switches, including System 75, a DEFINITY Generic 1 and Generic 3, or a DEFINITY ECS, a TN62B Hybrid pack must be used with the Universal carrier for this purpose.



**NOTE:**

A DEFINITY Generic 2 may use either an ANN17B or a TN62B pack. In either case, the latest vintage packs are recommended.

### Button Numbering

Only the system manager should administer feature button assignments on the telephone. It is recommended that you not use a feature that requires visuals (that is, the light next to each administrable button) to be updated while the set is turned off, or any feature that may be activated by button depression while the set is turned off (for example, Send All Calls).

Use Figure 18-8 for button numbering on the MDW 9000 set when it is connected to a System 75, a DEFINITY Generic 1, Generic 3 switch, or a DEFINITY ECS. Use Figure 18-9 for button numbering on the MDW 9000 set when it is connected to a System 85 or a DEFINITY Generic 2.



**NOTE:**

On System 75, a DEFINITY Generic 1 and 3, or a DEFINITY ECS, button numbering begins with "1," the button on the upper right of the display. On System 85 and a DEFINITY Generic 2, button numbering starts with "3."

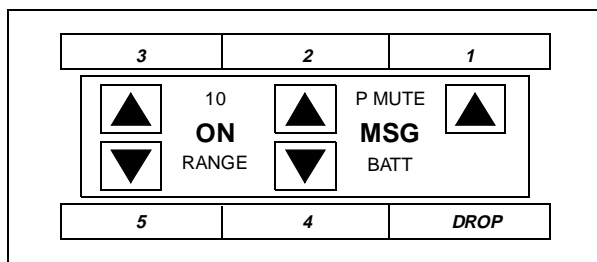

Figure 18-8. Button Numbering for an MDW 9000 Connected to a System 75, a DEFINITY Generic 1 or 3, or a DEFINITY ECS

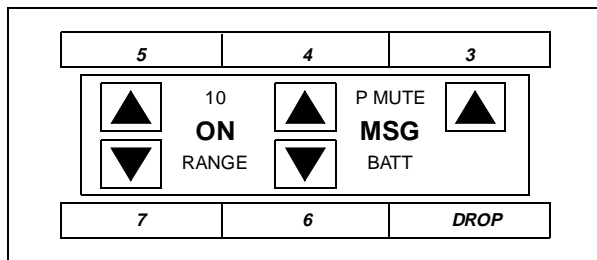

Figure 18-9. Button Numbering for an MDW 9000 Connected to a System 85 or a DEFINITY Generic 2

## FCC Registration

The MDW 9000 telephone has been tested and has been found to comply with FCC Part 15 Rules.

## Hearing Aid Compatibility

This wireless telephone is compatible with inductively-coupled hearing aids.

## UL and CSA Approval

This voice terminal has been tested and has met the Underwriters Laboratories (UL) Standards UL 1459 and have also met the Canadian Standards Association (CSA) Standards CSA-C22.2 No.225-M90.

## MDW 9000 Equipment PECs and Comcodes

The MDW 9000 telephone and components can be ordered with these PECs and Comcodes:

- **MDW 9000 Telephone (sold separately)**

- Black = PEC: 3204-01B  
Comcode: 107017022  
White = PEC: 3204-01B  
Comcode: 107017030

- **MDW 9000 Multiple Unit (sold as a unit)**

- Black = PEC: 3204-W1B  
Comcode: 107077444  
White = PEC: 3204-W1W  
Comcode: 107077463

- **Carrier Assembly/Backplane**

- PEC: 3204-CR1  
Comcode: 107073330

- **Headset**

- PEC: 3122-041

- **Battery Pack**

- Black = PEC: 32036  
Comcode: 106760804  
White = PEC: 32034  
Comcode: 106760812

- **Holster**

- Gray  
Comcode: 846628527  
Black  
Comcode: 846501401

- **8-foot Line Cord**

- Comcode: 103786794

- **Charging Cradle**

- Black = PEC: 107076754  
White = PEC: 107076762

- **Carrier Assembly**

- Comcode: 107073330

**18** Cordless and Wireless Telephones  
*The MDW 9000 Wireless Telephone*

18-23

- **Carrier Assembly AC Adapter**  
Comcode: 847224227
- **Radio Module AC Adapter**  
Comcode: 847180890
- **Charging Cradle AC Adapter**  
Comcode: 847180890

## **Additional Documents**

---

The following documents contain additional information relating to the MDW 9000 Wireless Telephone: (Use the 9 digit number listed after each document to order that book from the BCS Publications Center for Lucent Technologies.)

- *DEFINITY Generic 1, 2, and 3, System 75 and System 85 MDW 9000 Wireless Telephone User's Guide, 555-230-768*
- *MDW 9000 Wireless Telephone Installation Manual, 503-801-111*
- *MDW 9000 Wireless Telephone Quick Reference, 503-801-110*

## The MDW 9031DCP Wireless Pocket Phone

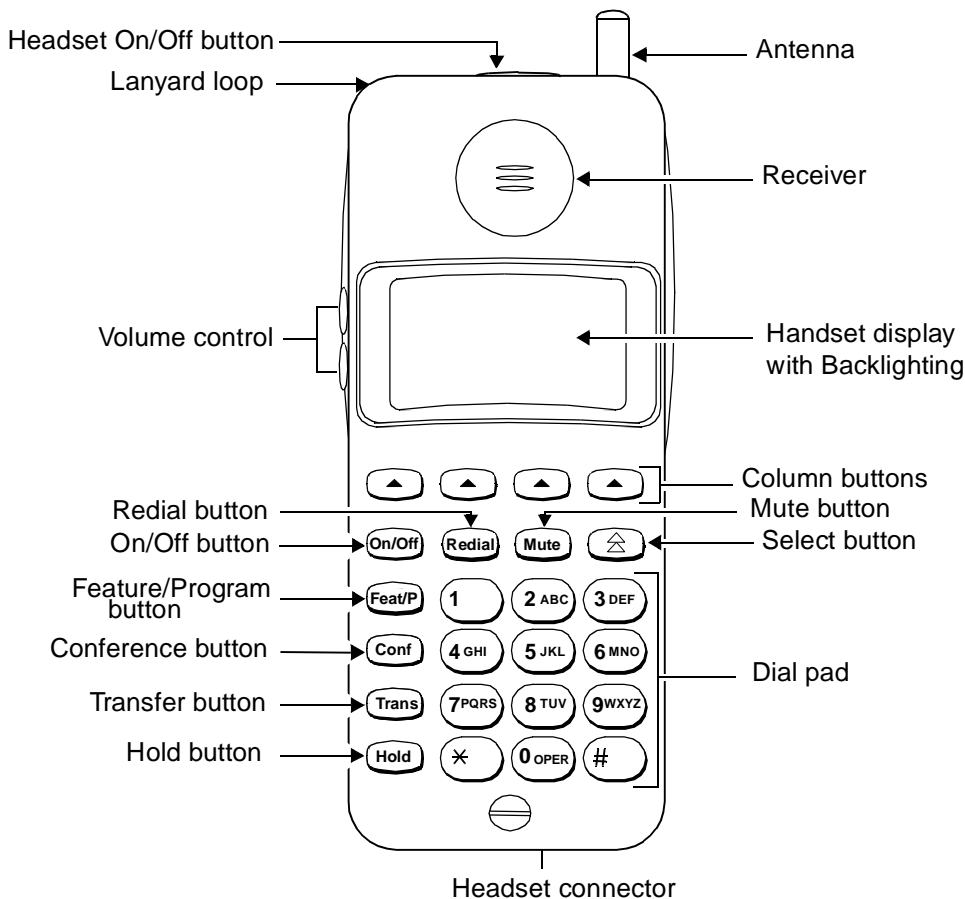

Figure 18-10. The MDW 9031DCP Wireless Pocket Phone



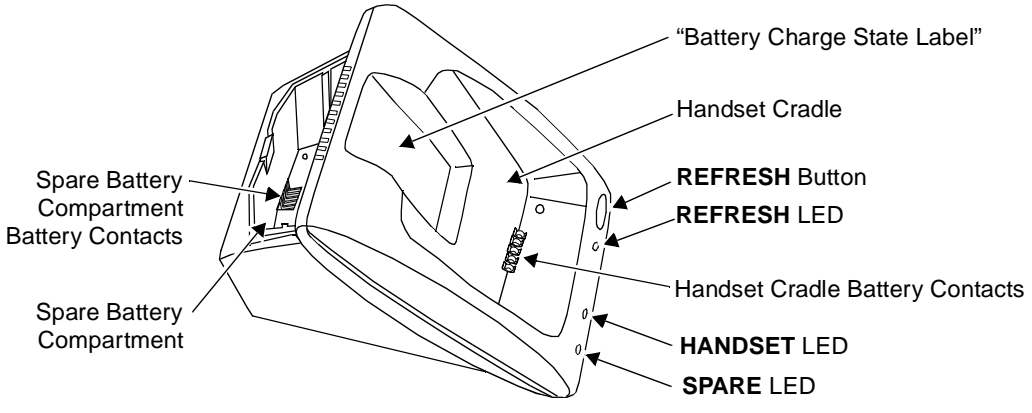

Figure 18-11. The Battery Charger

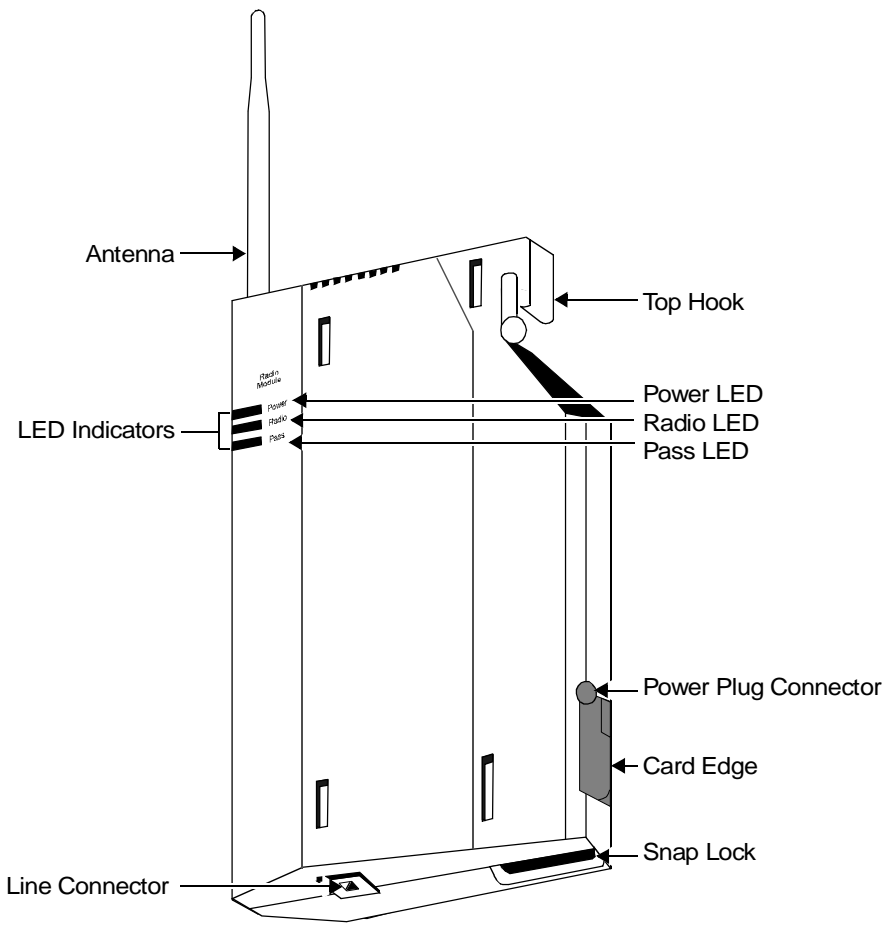

Figure 18-12. The MDW 9031DCP Wireless Pocket Phone, Radio Module

18 Cordless and Wireless Telephones

*The MDW 9031DCP Wireless Pocket Phone*

18-27

The MDW 9031DCP Wireless Pocket Phone is part of the TransTalk™ 9000 Digital Wireless System family of telephones. This phone comes in two models, the single-zone model and the dual-zone model, according to whether the phone will be connected to one radio module (a single-zone configuration) or two radio modules (a dual-zone configuration).

This wireless Pocket Phone has three basic parts, the handset the battery charger, and the radio module.

- The handset has line/programmable feature/intercom buttons, Mute, Hold, Conference, and Transfer buttons, a Headset On/Off button and a Handset On/Off button, a LCD display with Backlighting, a Volume control, battery charging contacts, a flexible antenna, and a Headset jack.
- The battery charger has a handset hook, a spare battery cover, and a spare battery.
- The radio module has Power, Pass, and Radio indicator lights, and a top hook, card edge, and snap lock which connect the radio module to the carrier assembly/backplane, an antenna, and power plug, and line connectors.

In order to provide you with the freedom of mobility, the MDW9031DCP is not connected physically (by a line cord or wire from the handset) to the DEFINITY Communications System Generic 1, Generic 2, or Generic 3, or the DEFINITY ECS. Instead, the MDW 9031DCP communicates by way of a radio link to its matched radio module, which, in turn, connects it to the DEFINITY switch or the DEFINITY ECS. The telephone needs merely an electrical outlet, and a test check to make sure that the handset is in range of its matching radio module.

The handset communicates through a matching radio module. When up to six wireless phones are used within a single location, a carrier assembly is required.

The Dual Zone model allows you to link up with either of two different radio modules, thereby expanding the coverage area since you are able to use the same phone to place and answer calls for the radio module in Zone 1 or the radio module in Zone 2.



**NOTE:**

Dual Zone installations require two station ports — one for each radio module.

## Applications

The MDW 9031DCP Wireless Pocket Phone, both single-zone and dual-zone models, can be used with the DEFINITY Communications System Generic 1, Generic 2, and Generic 3, the DEFINITY ECS, System 75, and System 85.

## Physical Features

---

### Dimensions



**NOTE:**

The dimensions described here for the MDW 9031DCP Pocket Phone are approximate.

**For the Handset:**

Width = 2.25 inches

Length = 6 inches

Depth = 1.0 inches

Weight: 33 pounds

**For the Battery Charger:**

Width = 3.94 inches

Length = 9.75 inches

Height = 5.13 inches

**For the Radio Module:**

Width = 5.5 inches

Length = 12.1 inches

Height = 1.5 inches

### Handset Features

#### Fixed Feature Buttons

The MDW 9031DCP Pocket Phone has the following ten types of fixed feature buttons:

- CONFERENCE button — labeled CONF
- TRANSFER button — labeled TRANS
- HOLD button
- FEATURE/PROGRAMMING button — The Feature button (labeled FEAT/P) is not used for DEFINITY features.
- MUTE button — The MUTE button is used to turn on and off the microphone associated with the handset *or* the headset.
- REDIAL button — The REDIAL button is used to redial the last number you dialed from the dial pad.
- SELECT button — The SELECT button (labeled ) is used to move the Selection rectangle, and together with the Column buttons, to choose a line or programmable/intercom/drop button. It is also used to wake-up the phone.

## 18 Cordless and Wireless Telephones

*The MDW 9031DCP Wireless Pocket Phone*

18-29

- Four COLUMN buttons — these buttons (labeled ) are used together with the SELECT button to choose a line or programmable/intercom/drop button.
- Headset On/Off button — This button is used for turning the headset on and off. Located on top of the handset, it is used when the headset jack is in use. At all other times, the Headset On/Off button is deactivated to prevent accidental call termination.
- Handset (labeled ON/OFF) button — This On/Off button is used for turning the handset on and off. (It can also be used to turn the headset on or off.)

### LCD Display

The display provides information on the status of lines and range, battery power, mute usage, etc.

### Dial Pad

This is the standard 12-button pad for dialing telephone numbers and accessing features.

### Volume Control Switch

The Volume control (labeled “+” and “-”) adjusts the receiver volume (higher or lower) when the handset is off-hook and adjusts the ring volume (higher or lower) when the handset is on-hook.

### Antenna

The antenna is used for receiving the transmissions from the radio module. This antenna is flexible and is permanently attached to the handset.

### Battery Charging Contacts

These contacts are used for charging the handset when contact is made with the charging cradle.

### Headset Connector

This jack is used for connecting the headset to the handset.

## Battery Charger Features

### Spare Battery Compartment

The Spare battery compartment refreshes the battery pack automatically by fully discharging it before recharging it. This process reduces or eliminates the potential “Memory” effect (which reduces a battery’s capacity when you repeatedly recharge a battery before it is fully discharged).

## **Handset Cradle**

The handset cradle charges a battery pack in the handset.

## **REFRESH button and Indicator**

When you press the REFRESH button, the battery pack in the handset cradle is refreshed by fully discharging the battery pack before recharging it. While the battery pack is being discharged, the REFRESH and HANDSET lights go on.

## **HANDSET Indicator**

The HANDSET light goes on when the handset battery pack is installed in the handset and the handset is inserted correctly into the battery charger handset cradle.

## **SPARE Indicator**

The SPARE Battery Pack light goes on when a battery pack is positioned correctly in the Spare battery compartment.

## **Battery Charging Contacts**

The battery charging contacts are used for charging the handset when contact is made with the charging cradle.

# **Radio Module Features**

## **Power and Pass Indicators**

The Power and Pass lights indicate when the module is powered up and completes its self-diagnostic. The Radio indicator light goes on when the handset is in use.

## **Top Hook and Card Edge**

The top hook and the card edge connect the radio module to the carrier assembly/backplane mounting rod.

## **Snap Lock**

This lock locks the radio module into the carrier assembly.

## **Antenna**

The sturdy and flexible antenna sends signals between the handset and the radio module.

## **Power Plug Jack**

The AC adapter should be inserted into this jack.

18 Cordless and Wireless Telephones

*The MDW 9031DCP Wireless Pocket Phone*

18-31

## Line Jack

The line cord should be inserted into this jack.

## Out-of-Range Indication

---

While the set is still active, it gives an audible indication (double beep) and visual indication (the **RANGE** icon appears on the LCD display) when the handset is getting out of range of the radio module.

## Distance and Installation Limitations

---

Both the MDW 9031 DCP single-zone and the dual-zone Pocket Phones can be installed in a single user configuration or a multiple user configuration with up to 30 handsets.

The MDW 9031DCP uses radio transmissions to communicate. The range depends on your particular operating environment. For indoor use, intervening walls will reduce the phone's range. Try to stay away from concentrations of structural metal, such as steel and aluminum, or reinforced concrete.

### NOTE:

At least 6 feet is required between the radio module or carrier and the phone system switch.

For each radio module or carrier you install, note the following considerations:

- The radio module or carrier(s) should not be within 3-feet of any large metal object and should not have metal objects in the line of sight to the operating area of the handset.
- The radio module or carrier(s) should not be within 6 feet of equipment with microprocessors such as answering machines, personal computers, and fax machines; control units, communications system switches, or other phones (especially speakerphones); competing radio devices such as wireless bar-code scanners; electromagnetic equipment such as electric motors; or electrical main power feeds, junction boxes, circuit-breaker panels, fuse boxes, or 220-volt power lines.
- The radio module or carrier(s) should not share the same power line as equipment with microprocessors such as answering machines, personal computers, and fax machines, or electromagnetic equipment such as electric motors.
- If your phone system uses an uninterruptible power supply, such as a backup generator, be sure to connect the radio or carrier(s) to that power supply.

Follow these additional rules for installing each radio module:

## 18 Cordless and Wireless Telephones

*The MDW 9031DCP Wireless Pocket Phone*

18-32

- Installing a single radio module on a shelf or desk is not recommended because it greatly reduces the range and quality of the transmission.
- Install a single radio module within 3 feet of either side of, and within 6-12 feet above, a properly grounded 3-prong electrical outlet that is not controlled by an on/off switch.
- For remote locations, an individual radio module can be installed in that area and attached via telephone line cord to the phone system. IROBs must be used for out-of-building installations.

**CAUTION:***A radio module cannot be installed outdoors.*

- The radio module should be placed high on the wall for optimum voice quality and range. Allow at least 1 foot of space between the top of the antenna on the radio module(s) and the ceiling.
- When installing the MDW 9031DCP Dual Zone Pocket Phone in the same building, you should limit how much overlap there is between radio module 1 and radio module 2. NO OVERLAP is ideal; minimal overlap between zones is also recommended.

If there is an extensive overlap condition, there will be interference between the radio modules, causing poor voice quality as well as rendering the handset inoperable. In the latter case, the **RANGE** icon will appear in the handset display.

Follow these additional rules for installing one or more carriers:

- Install carrier(s) within 15 feet of either side of, and within 6 to 8 feet above, a properly grounded 3-prong electrical outlet that is not controlled by an on/off switch.
- Choose a location where handset users will not approach the carrier(s) within a radius of 6 feet for 1 or 2 carriers or 10 feet for 3 carriers.
- When installing multiple carriers:
  - Install multiple carriers 1 foot optimally to 4 feet apart.
  - Install multiple carriers on the same horizontal axis (that is, do not install one carrier higher or lower than another)
  - Install the control carrier as the leftmost carrier, using only the expansion cables provided.
  - Slot 6 of an 117A3 control carrier must always contain a radio module to pass the synchronization signal to the next carrier.

**CAUTION:***Carrier(s) cannot be installed outdoors.*



## Switch Administration

### Aliasing

For all System 75 and System 85 releases and DEFINITY Generic 1, Generic 2, and Generic 3, Versions 1 and 2, the MDW 9031DCP Pocket Phone must be administered as an 8410D voice terminal.

For the MDW 9030DCP Dual Zone phones connected to a DEFINITY system prior to Release 5.0, you must administer two station ports (2 extensions) — one for each radio module. Each station port must be administered with three call appearances of its own and three call appearances of the other station extension number.

### Button Numbering

Use Figure 18-8 for button numbering on the MDW 9031DCP when it is connected to a DEFINITY switch.

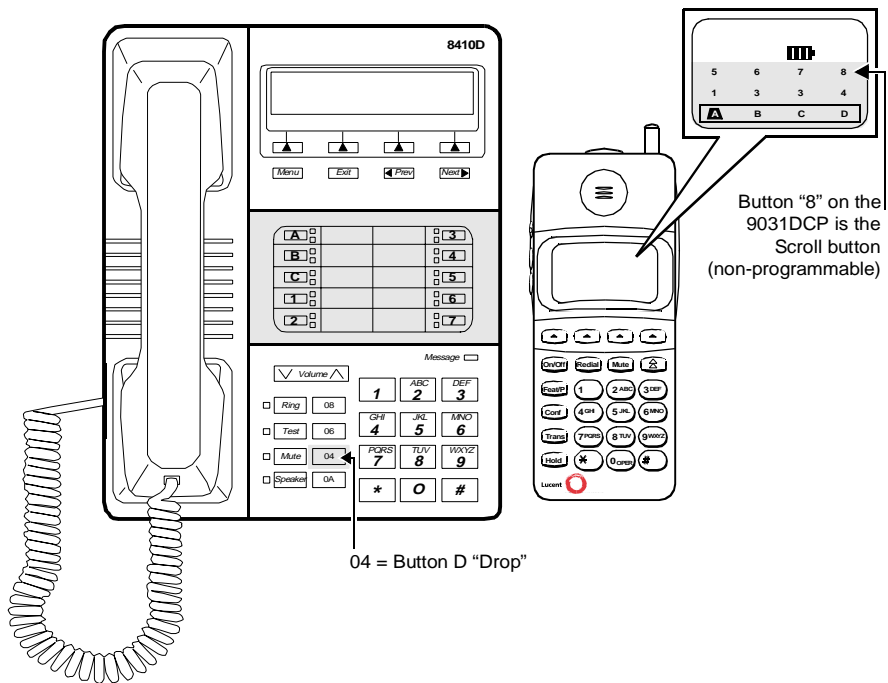

Figure 18-13. Button Numbering for an MDW 9031DCP Connected to a System 75, a DEFINITY Generic 1 or 3, or a DEFINITY ECS

18 Cordless and Wireless Telephones

*The MDW 9031DCP Wireless Pocket Phone*

18-34

## FCC Registration

The MDW 9031DCP Pocket Phone has been tested and has been found to comply with FCC Part 15 Rules.

## Hearing Aid Compatibility

The MDW 9031DCP is compatible with inductively-coupled hearing aids.

## UL and CSA Approval

The MDW 9031DCP has been tested and has met the Underwriters Laboratories (UL) Standards UL 1459 and have also met the Canadian Standards Association (CSA) Standards CSA-C22.2 No.225-M90.

## MDW 9031DCP Equipment PECs and Comcodes

The MDW 9031DCP Pocket Phone and components can be ordered with these PECs and Comcodes:

- **MDW 9031DCP Single Zone Pocket Phone System (Stand-Alone)**  
includes Radio Module and Kit of Parts  
PEC: 3204-07B  
For Pocket Phone – Comcode: 108046525  
For Kit of Parts – Comcode: 107586828
- **MDW 9031DCP Single Zone Pocket Phone System**  
(requires Carrier), includes Radio Module, but not Kit of Parts  
PEC: 3204-W7B  
Comcode: 108046525
- **MDW 9031DCP Dual Zone Pocket Phone System (Stand-Alone)**  
includes 2 Radio Modules and Kit of Parts  
PEC: 3229-SDZ  
For Pocket Phone – Comcode: 108401555  
For Kit of Parts – Comcode: 107586828
- **MDW 9031DCP Dual Zone Pocket Phone System**  
(requires Carrier), includes 2 Radio Modules, but not Kit of Parts  
PEC: 3229-MDZ  
Comcode: 108401555
- **Retractable Flex Antenna** for MDW9031DCP Pocket Phone Handset  
Comcode: 847713450
- **Carrier** – includes:  
Power Cord (25 foot) and AC Adapter for Carrier and  
Expansion Cable (6 foot) for Multiple-Carrier Installation

18 Cordless and Wireless Telephones

*The MDW 9031DCP Wireless Pocket Phone*

18-35

PEC: 3204-CR3A

For 117A3 Carrier – Comcode: 107907289

For 117A4 Carrier – Comcode: 107955122

**Power Cord (25 feet) and AC Adapter for Carrier**

Comcode: 847224227

**Expansion Cable (6 foot) for Multiple-Carrier Installation**

PEC: 32035A

Comcode: 847667870

- **Standard Battery Pack**, includes Carrying Clip

PEC: 32045A

Comcode: 107733107

**Carrying Clip for Standard Battery Pack**

Comcode: 847773140

- **Extended Battery Pack**, includes Carrying Clip

PEC: 32049A

Comcode: 107733115

**Carrying Clip for Extended Battery Pack**

Comcode: 847773157

- **Battery Charger**, includes Power Cord (11 foot) and AC Adapter

PEC: 32047A

Comcode: 107733099

**Power Cord (11 foot) and AC Adapter for Battery Charger**

Comcode: 847713583

- **MDW9031DCP Pocket Phone Leather Carrying Case**

PEC: 32043A

Comcode: 847877487

**MDW9031DCP Pocket Phone Leather Carrying Case  
customized for headset use**

PEC: 32090A

Comcode: 848026092

- **Lanyard**

Comcode: 407183417

- **Telephone Line Cord (8 feet)**

Comcode: 103786794

- **Supra 9031 Headset with Adapter**

PEC: 3123-152A

For Headset – Comcode: 407654490

For Adapter – Comcode: 848047965

**9031 Quick Disconnect Adapter** for Supra 9031 or Radium Headset

PEC: 3124-RCA

Comcode: 848047965

**Radium (Over the Ear) Headset with Adapter**

PEC: 3123-153A

For Headset – Comcode: 407720739

For Adapter – Comcode: 848047965

18 Cordless and Wireless Telephones

*The MDW 9031DCP Wireless Pocket Phone*

18-36

- **Kit of Parts (for Stand-Alone Installations)**

- includes Power Cord (11 foot) and AC Adapter for Radio Module

- PEC: D-182866

- Comcode: 107586828

## Additional Documents

The following documents contain additional information relating to the MDW9031DCP Wireless Pocket Phone: (Use the 9 digit number listed after each document to order that book from the BCS Publications Center for Lucent Technologies.)

- *TransTalk 9000 Digital Wireless System MDW9031DCP Wireless Pocket Phone Installation and Use*, 503-801-166
- *MDW 9031/9031DCP Wireless Pocket Phone Quick Reference*, 503-801-165

## Other Voice Terminals

# 19

---

### **Voice Terminals Reusable from Other Systems**

---

The customer may have voice terminals that were used with a previous system that are compatible with System 75 and System 85. The installation of these reusable voice terminals in a System 75 or System 85 is possible, but not recommended.

#### **Advantages of Reusable Terminals**

---

The main advantage of reusable terminals is a modest cost savings.

#### **Disadvantages of Reusable Terminals**

---

Reusable terminals have the following disadvantages:

- No access to data communications
- Incompatible with System 75 and System 85 adjuncts
- No alphanumeric displays
- Difficult administration

19 Other Voice Terminals

Models 7302H, 7303H, 7305H01B, and 7305H02B

19-2

## Models 7302H, 7303H, 7305H01B, and 7305H02B

---

These MERLIN Communication System voice terminals are similar in appearance and functions to System 75 and System 85 multi-appearance terminals.

The 7302H is a 5-button voice terminal that can be desk or wall mounted. This set can no longer be ordered.

The 7303H is a 10-button voice terminal that can be desk or wall mounted. This set can no longer be ordered.

The 7305H series is a 34-button voice terminal. This terminal can be equipped with or without different features such as built-in speakerphone or display. Some versions of the 34-button series can be ordered using PEC code 3162 and the appropriate suffix.

## Multi-Button Electronic Telephone (MET) Sets

---

These DIMENSION<sup>®</sup> PBX voice terminals have some of the capabilities of System 75 and System 85 multi-appearance terminals.

The MET sets are available in 10-, 20-, and 30-button versions. (See Figures 19-1 through 19-5.) These three types of MET sets can be used with DEFINITY Generic 1, Generic 2, and Generic 3, a DEFINITY ECS, System 75, and System 85. The 10-button version can be desk or wall mounted. All the others must be desk mounted. The 10-button version can be equipped with a built-in speakerphone. The MET sets can be ordered using PEC code 3140 and the appropriate suffix.

 **NOTE:**

On System 85 and DEFINITY G2, the bottom five buttons on a MET set become fixed feature buttons. On a 5-button MET set, that leaves no room for call appearances. Therefore, the 5-button MET set *cannot* be used with System 85 and DEFINITY G2.

19 Other Voice Terminals

Multi-Button Electronic Telephone (MET) Sets

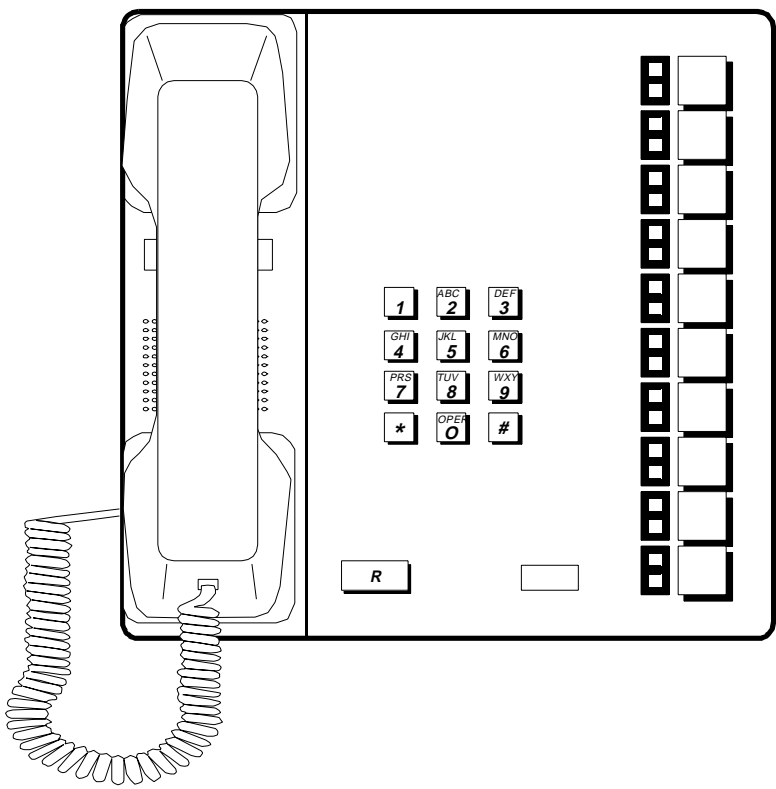

Figure 19-1. The 10-Button MET (Desk) Set

19 Other Voice Terminals

Multi-Button Electronic Telephone (MET) Sets

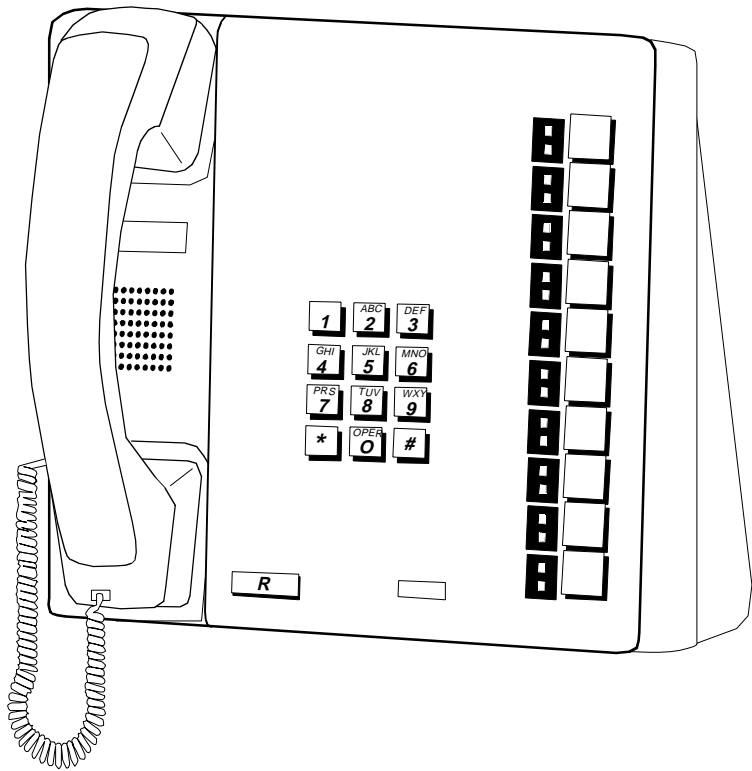

Figure 19-2. The 10-Button MET (Wall) Set



19 Other Voice Terminals

Multi-Button Electronic Telephone (MET) Sets

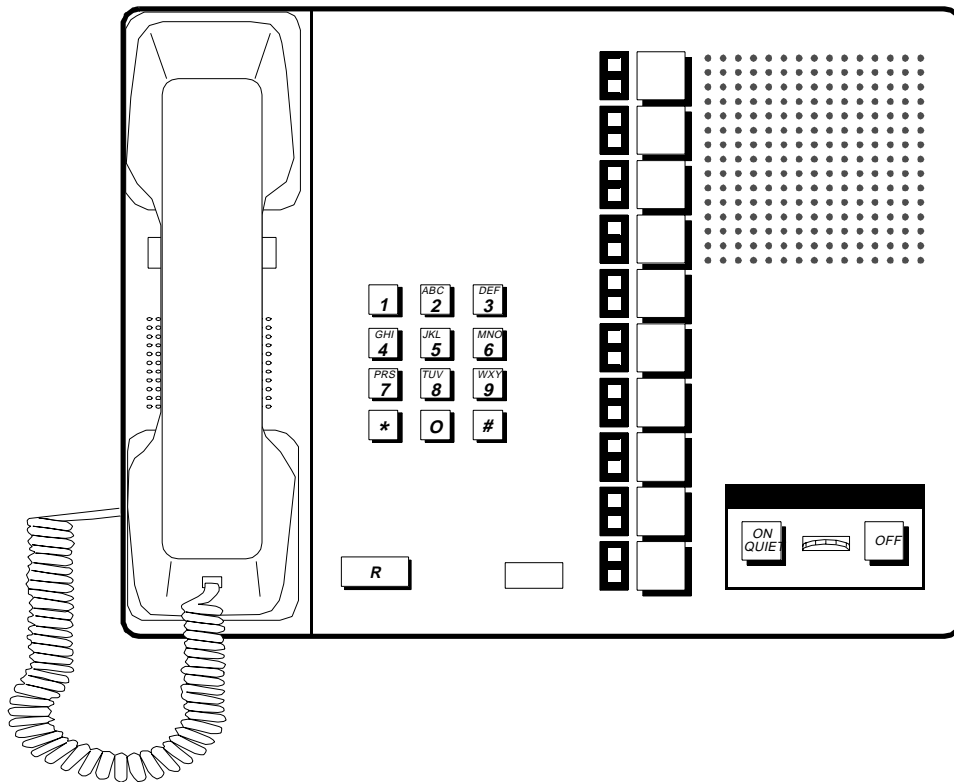

Figure 19-3. The 10-Button MET Set with Speakerphone

19 Other Voice Terminals

Multi-Button Electronic Telephone (MET) Sets

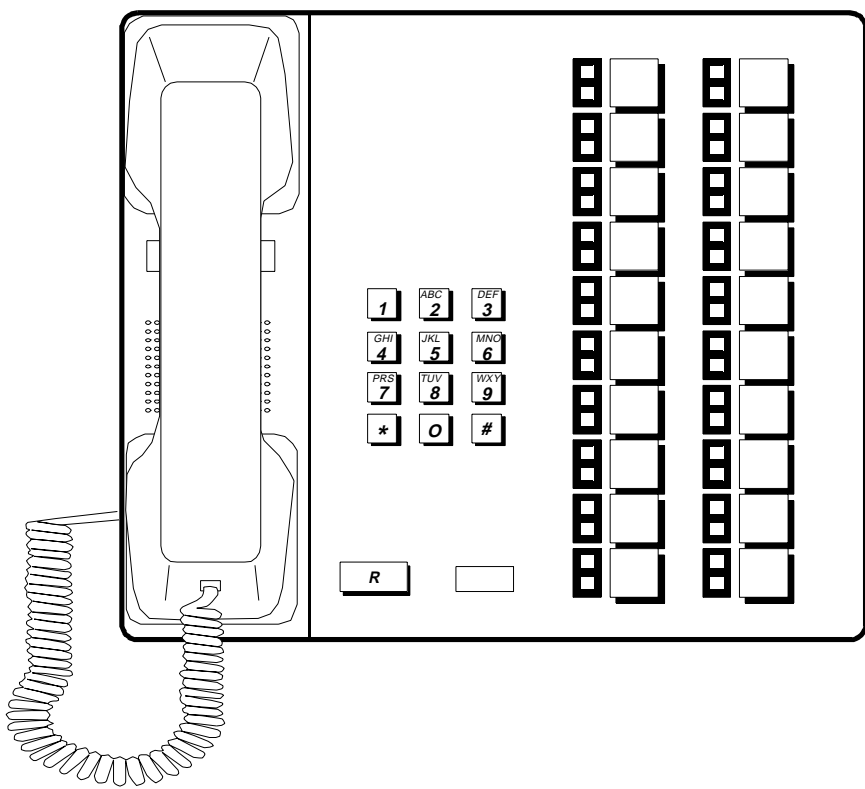

Figure 19-4. The 20-Button MET (Desk) Set

19 Other Voice Terminals

Multi-Button Electronic Telephone (MET) Sets

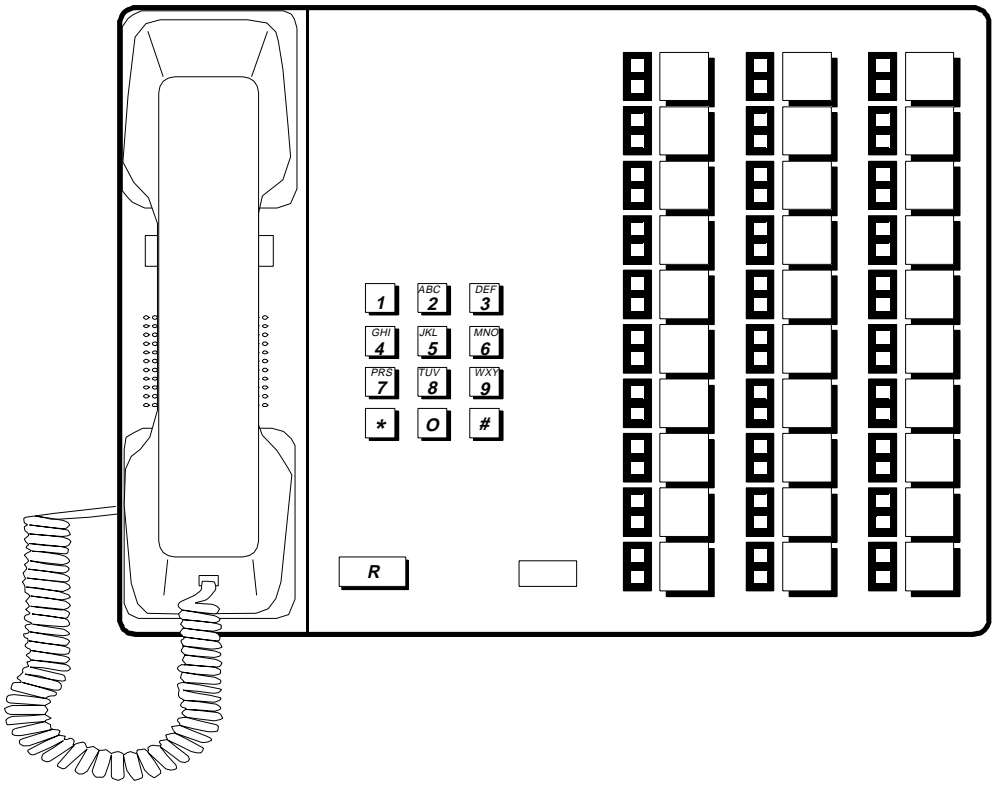

Figure 19-5. The 30-Button MET (Desk) Set

**19 Other Voice Terminals**

*Multi-Button Electronic Telephone (MET) Sets*

19-8

## Adjuncts

# 20

---

This section describes the devices that can be used with voice terminals to supplement services and features. The information provided here includes specifics on the controls, buttons, lights, and functions of voice terminal adjuncts that can be connected to the DEFINITY Communications System Generic 1, Generic 2, and Generic 3, the DEFINITY ECS, System 75, and System 85. Adjuncts that are identical in appearance and function, but have different codes, are covered under the same heading. Adjuncts that are basically data modules are covered in the **Data Modules** section later in this manual.

The adjuncts covered in this section are:

- Call Coverage Modules
- Digital Display Modules
- Function Key Modules
- Expansion Modules
- 100A Tip/Ring Module
- Headset Adapters
- Z34A Message Waiting Indicator
- Speakerphones
- Loudspeaker
- 7404D (Voice Terminal) Messaging Cartridge
- 2870A1 37Automatic Dialer

## Call Coverage Modules

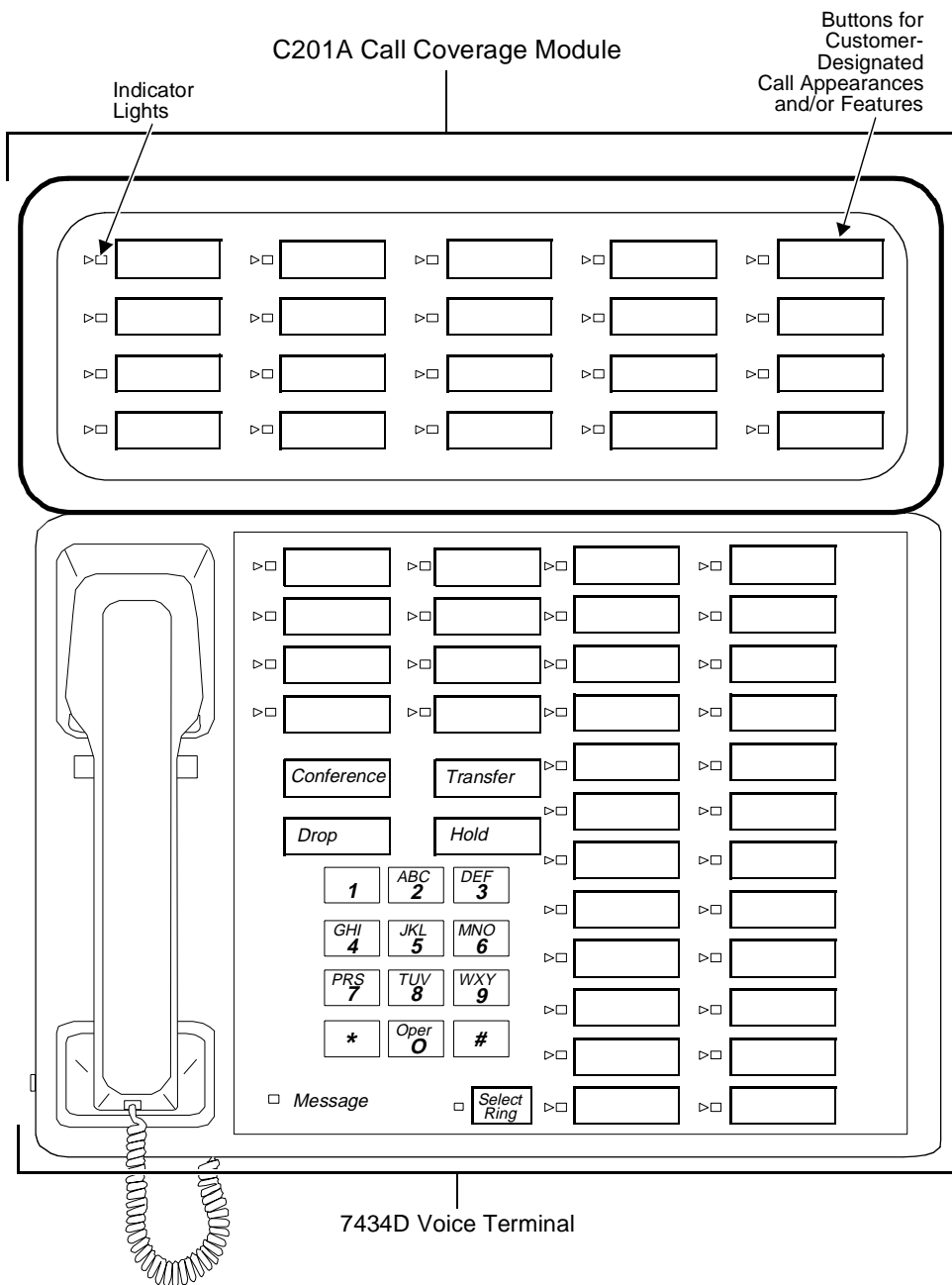

Figure 20-1. The C201A Call Coverage Module Mounted on a 7434D Voice Terminal

**20** Adjuncts

## Call Coverage Modules

20-3

The C201A Call Coverage Module and the C401A and C401B Call Coverage Module are identical in appearance, operation, and function. The Call Coverage Module provides 20 call appearance/feature buttons to supplement those on the associated voice terminal.

**NOTE:**

The C201A module and 7205H voice terminal were discontinued in March 1988. The C102A module has also been discontinued.

## Applications

---

The Call Coverage Module can be used with the DEFINITY Communications System Generic 1, Generic 2, and Generic 3, the DEFINITY ECS, System 75, and System 85. The C201A is used with the 7205H multi-appearance hybrid voice terminal (System 85 and G2 only), while the C401A and C401B are used with the 7405D and 7434D voice terminals.

## Physical Description

---

### Features

#### Buttons

Each of the 20 call appearance/feature buttons has a triangular red light and a square green status light. The buttons used for features have only a status light. The module buttons can be used for a variety of purposes:

- Bridged appearances of extension numbers of other voice terminals
- Additional appearances of the primary extension number of the voice terminal to which it is attached (up to a total of 12 for both terminal and module)
- Identification of incoming calls for a call coverage answer group, a Direct Department Calling (DDC) group, or a Uniform Call Distribution (UCD) group
- Optional features as designated by the system manager

### Other Physical Features

#### Mounting

The Call Coverage Module is mounted to the back of the associated voice terminal at an angle that allows it to be easily used.

#### Color Options

The Call Coverage Modules are available in black or misty cream.

## Power

---

The C201A Call Coverage Module draws its required power from the system switch through the 7205H voice terminal to which it is attached; *no auxiliary power is required*. However, when a C401A or C401B module is used with a 7405D or 7434D voice terminal, auxiliary power must be fed through the terminal's line cord from one of the sources listed in the **Adjunct Power** section earlier in this manual.

## Considerations

---

A Call Coverage Module and a Digital Display Module *cannot* be mounted on the same voice terminal simultaneously. The voice terminal *cannot* be wall mounted if equipped with the Call Coverage Module.

## Call Coverage Module PECs

---

The C201A, C401A, and C401B Call Coverage Modules were ordered with the following PECs:

- **C201A Call Coverage Module** — PEC: 31720 (not orderable)
- **C401A Call Coverage Module** — 31743 (not orderable)
- **C401B Call Coverage Module**  
(Black) PEC: 31743-003  
(Misty cream) PEC: 31743-215 (not orderable)



## Digital Display Modules

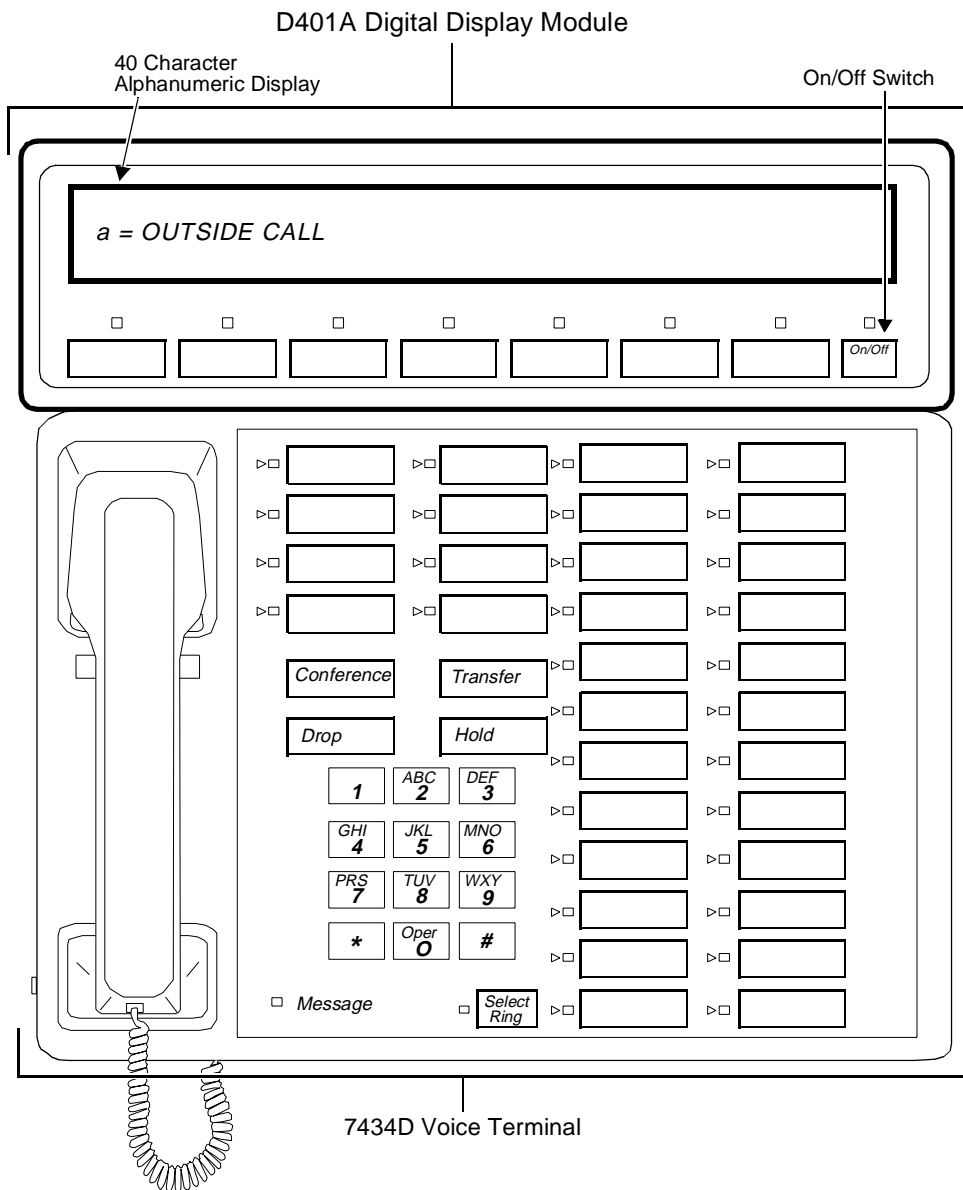

Figure 20-2. The D401A Digital Display Module Mounted on a 7434D Voice Terminal

The D401A and D401B Digital Display Modules add a large easy-to-read 40-character display to the top of the 7405D or 7434D voice terminal. The D401 provides a vacuum-fluorescent display, which is significantly brighter than LCD displays and visible from any angle. It provides prompt retrieval of Leave Word Calling or Message Center messages, can identify incoming calls, both names and number, and perform other functions.

## Applications

---

The Digital Display Module can be used with the DEFINITY Communications System Generic 1, Generic 2, and Generic 3, the DEFINITY ECS, System 75, and System 85. It is used with the 7405D and 7434D voice terminals. It is particularly useful for receptionists and executives.

## Physical Description

---

### Features

#### Automatic Displays

The D401A/B Digital Display Module automatically provides a visual display of the following call-related information:

- Calling and called party identification
- Calling and called number
- Call coverage status

#### Auxiliary Displays

In its various auxiliary modes, the Digital Display Module also provides other services:

- Time and date display
- Elapsed time on calls
- Message retrieval
- Display of stored abbreviated dialing numbers
- Access to Integrated Directory (except on System 85 or a DEFINITY G2)

#### Display

A vacuum-fluorescent 40-character alphanumeric display that presents numerical digits, uppercase and lowercase letters, and punctuation marks.

## On/Off Switch

The On/Off switch turns the module on and off. The associated green status light goes on when the module is on and is dark when the module is off.

## Assignable Function Buttons

Seven additional buttons with associated green status lights. The system manager assigns these buttons to display the control functions.

## Display Functions

The following display functions are available on buttons (the actual labeling on some buttons is shortened). If more than seven buttons are required, the additional buttons may be assigned on the associated voice terminal.

- **Normal Mode** — used to place the display in the Normal mode, in which the display provides call-related information automatically.
- **Inspect Mode** — used to place the display in the Inspect mode to permit the user to see caller identification on an incoming or held call while active on another call.
- **Message Retrieval** — used to place the display in the Message Retrieval mode, in which the user can retrieve messages for the voice terminal on which the module is mounted
- **Coverage Message Retrieval** — used to place the display in the Coverage Message Retrieval mode, in which coverage agents can retrieve messages for other terminals.
- **Next** — used in Message Retrieval mode to step from one message to the next; also used in the Integrated Directory feature to display the next name (except on System 85 or a DEFINITY G2).
- **Delete Message** — used in Message Retrieval mode to delete messages.
- **Make Call** — used in Message Retrieval mode to automatically initiate a call to the caller identified by the last displayed message (for internal calls only); also used to automatically call internal extension numbers displayed by the Integrated Directory feature (except on System 85 or a DEFINITY G2).
- **Integrated Directory** (except on System 85 or a DEFINITY G2) — used to place the display in the Integrated Directory mode, in which the user can search the system directory by entering the desired name with the dial pad, and names with their corresponding extension numbers will be displayed.

20 Adjuncts

Digital Display Modules

20-8

- **Stored Number** — used to enable inspection of numbers stored in Abbreviated Dialing (AD) lists or on individual AD buttons, or stored by the Last Number Dialed feature. On System 85, this function is available on some versions of R2V3 and R2V4, and G2.
- **Timer** — used to start or stop the elapsed timer function on the display module; displays hours, minutes, and seconds.
- **Date/Time** — used to place the display in the Time of Day and Date mode which initiates a display of the current time of day and the date.

## Other Physical Features

### Mounting Options

The Digital Display Module is mounted to the back of the associated voice terminal at an angle that allows it to be easily used.

### Color Options

The Digital Display Module is black or misty cream.

## Power

---

The Digital Display Module requires auxiliary power from an external source. The **Adjunct Power** section earlier in this manual lists the recommended power supplies for the module alone or in combination with other adjuncts.

## Considerations

---

A Digital Display Module and a Call Coverage Module *cannot* be mounted on the same voice terminal simultaneously. The voice terminal *cannot* be wall mounted if equipped with the Digital Display Module.

## Digital Display Module PECs

---

The D401A Digital Display Module can be ordered with the following PECs:

- **D401A Digital Display Module** — PEC: 31742
- **D401B Digital Display Module**  
(Black) PEC: 31742-003  
(Misty cream) PEC: 31742-215

## Function Key Modules

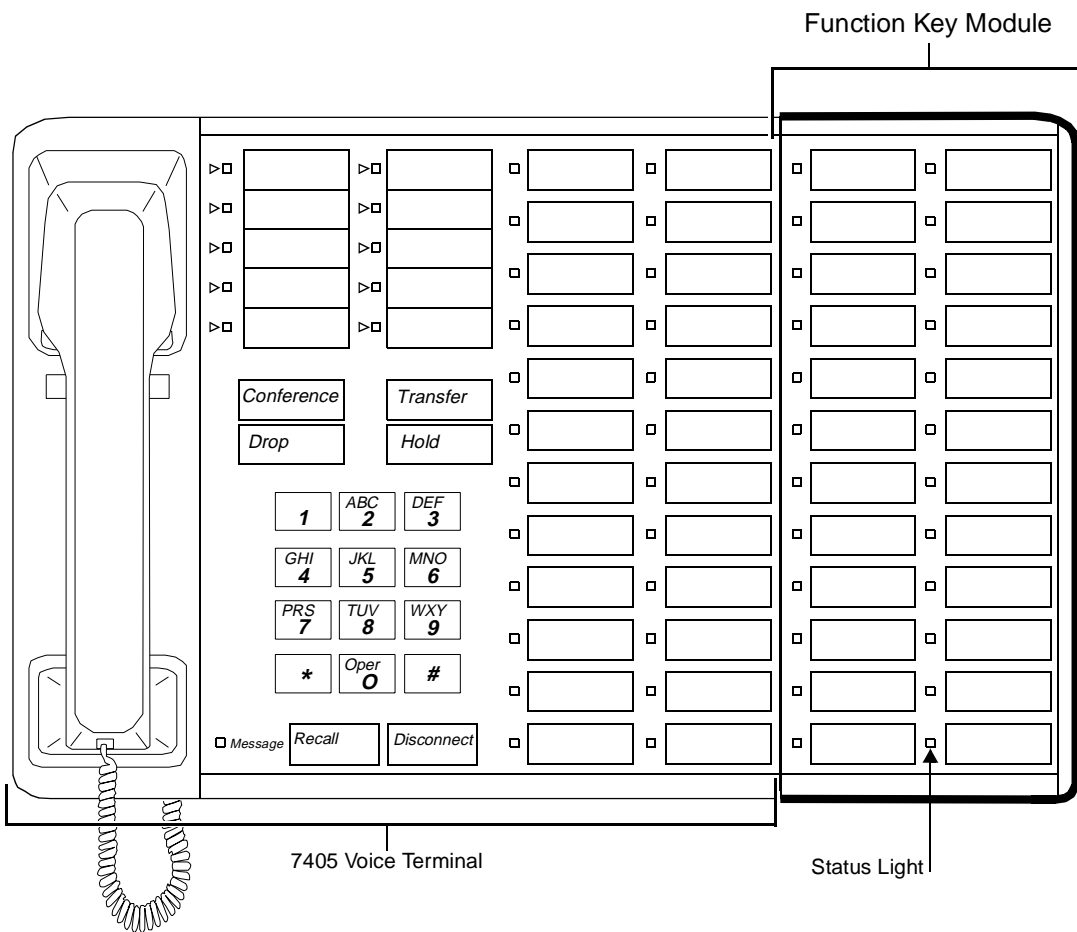

Figure 20-3. The F201 or F401A DEFN Key Module Mounted on a 7405D Voice Terminal

The Function Key Module greatly extends the feature access capability of the voice terminal where it is used. The module provides 24 buttons that can be assigned only to features. The F201A Function Key Module and the F401A Function Key Module are identical in appearance, operation, and function.



**NOTE:**

Both the F201A and F401A function key modules have been manufacture discontinued.

## Applications

---

The Function Key Module can be used with the DEFINITY Communications System Generic 1, Generic 2, and Generic 3, the DEFINITY ECS, System 75, and System 85. The F201A is used with the 7205H multi-appearance hybrid voice terminal (System 85 and the DEFINITY G2 only), while the F401A is used with the 7405D digital terminal.

## Physical Description

---

### Features

#### Feature buttons

The module provides 24 buttons that can only be assigned features. Each button has a square green status light.

### Other Physical Features

#### Mounting Options

As Figure 20-3 shows, the module attaches to the right side of the voice terminal, adjacent to the terminal's two columns of feature buttons. If a Digital Terminal Data Module is also installed, it must be mounted on the right side of the Function Key Module.

#### Color Options

The Function Key Module is silver.

## Power

---

The F201A Function Key Module draws its required power from the system switch through the 7205H voice terminal to which it is attached; no auxiliary power is required. However, when an F401A module is used with a 7405D digital terminal, auxiliary power must be fed through the terminal's line cord from one of the sources listed in the **Adjunct Power** section earlier in this manual.

## Considerations

---

Either a Digital Terminal Data Module, a Call Coverage Module, or a Digital Display Module can be mounted on the same terminal with a Function Key Module.

20 Adjuncts

Function Key Modules

20-11

## Digital Terminal Data Module PEC Codes

The F201A and F401A Function Key Modules were ordered using the following PECs:

- **F401A Function Key Module** — PEC: 31744
- **F201A Function Key Module** — PEC: 31721

## The 801A Expansion Module

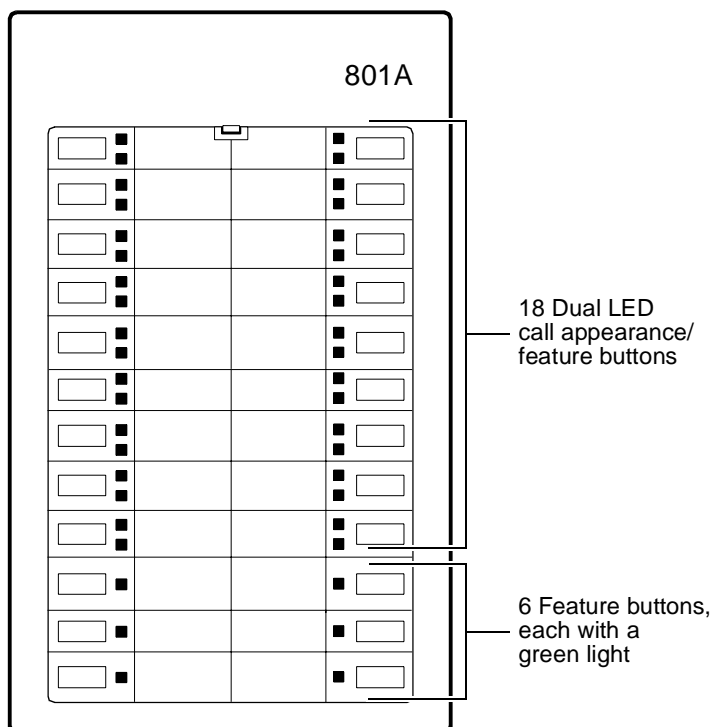

Figure 20-4. The 801A Expansion Module

The 801A Expansion Module is an optional device which can be connected to an 8434DX (8434D02A) voice terminal to extend the number of call appearance and feature buttons available on the voice terminal.

**⇒ NOTE:**

This expansion module can be connected ONLY to an 8434DX model connected to a DEFINITY G3V3.3 (or later). The 8434DX has an Ex Mod jack (labeled "EX MOD") to which the 801A can be connected. Before installing the expansion module to an 8434DX, make sure that the set is labeled "8434DX," has the "EX MOD" jack on the bottom of the set, and is connected to a DEFINITY G3V3.3 (or later).



## Applications

---

The 801A Expansion Module can be connected only to an 8434DX voice terminal.

## Physical Description

---

### Features

#### Buttons

The expansion module has 24 buttons arranged in two columns.

- The top 18 buttons (that is, the top nine buttons in each column) have a red and a green light next to them. These buttons can be used for call appearances or features.
- The bottom six buttons (that is, the last three buttons in each column) have a single green status light next to them. These buttons can be used for features only.

### Other Physical Features

#### Mounting

The 801A Expansion Module is connected to an 8434DX voice terminal with a D6AP-87 cord. This cord is plugged into the EX MOD jack on the voice terminal and then plugged into the TELSET jack on the expansion module.

#### Color Options

The Expansion Module is available in black or in white.

## Power

---

The expansion module requires auxiliary power.

- Suitable stand-alone power supplies include the 1151A1 and 1151A2 with Battery Holdover, and the MSP-1.



#### NOTE:

Since the 8434DX voice terminal requires auxiliary power, it is likely that an MSP-1 will already be connected to the 8434DX terminal.

- Suitable bulk power supplies are the 1145A and the 1145B1.

## Administering the 801A Expansion Module

The 8434DX with an attached expansion module can be used ONLY with systems such as a DEFINITY G3V3.3 or later that allow native support. That is, the 8434DX MUST BE ADMINISTERED AS ITSELF, not aliased as any other type of voice terminal.

On the first station administration screen of the 8434DX, put a "Y" (for Yes) next to the "Expansion Module?" entry. On the last page of the administration screens, type the telephone or extension numbers or feature names next to the appropriate expansion module buttons in the following sequence.

**NOTE:**

You can place ONLY features on expansion module Buttons #10, 11, 12, 22, 23, and 24. You CANNOT administer these buttons as call appearances.

801A					
<input type="checkbox"/>	<input type="checkbox"/>	1	13	<input type="checkbox"/>	<input type="checkbox"/>
<input type="checkbox"/>	<input type="checkbox"/>	2	14	<input type="checkbox"/>	<input type="checkbox"/>
<input type="checkbox"/>	<input type="checkbox"/>	3	15	<input type="checkbox"/>	<input type="checkbox"/>
<input type="checkbox"/>	<input type="checkbox"/>	4	16	<input type="checkbox"/>	<input type="checkbox"/>
<input type="checkbox"/>	<input type="checkbox"/>	5	17	<input type="checkbox"/>	<input type="checkbox"/>
<input type="checkbox"/>	<input type="checkbox"/>	6	18	<input type="checkbox"/>	<input type="checkbox"/>
<input type="checkbox"/>	<input type="checkbox"/>	7	19	<input type="checkbox"/>	<input type="checkbox"/>
<input type="checkbox"/>	<input type="checkbox"/>	8	20	<input type="checkbox"/>	<input type="checkbox"/>
<input type="checkbox"/>	<input type="checkbox"/>	9	21	<input type="checkbox"/>	<input type="checkbox"/>
<input type="checkbox"/>	<input type="checkbox"/>	10	22	<input type="checkbox"/>	<input type="checkbox"/>
<input type="checkbox"/>	<input type="checkbox"/>	11	23	<input type="checkbox"/>	<input type="checkbox"/>
<input type="checkbox"/>	<input type="checkbox"/>	12	24	<input type="checkbox"/>	<input type="checkbox"/>

Figure 20-5. Button Numbering for Administering the 801A Expansion Module

20 Adjuncts

*The 801A Expansion Module*

20-15

## **801A Expansion Module PECs**

---

The 801A Expansion Module can be ordered with the following PECs:

- **Black ZE801A-003 Expansion Module**  
(Black) PEC: 32300, Comcode: 106702921  
(White) PEC: 32301, Comcode: 106702764
- **2-foot D6AP-87 line cord**  
Comcode: 105644744

## **Additional Documents**

---

The following document is shipped with the expansion module. Additional copies are available from the BCS Publications Center for Lucent Technologies:

- *801A Expansion Module Instruction Manual, 555-015-136*

## The XM24 Expansion Module

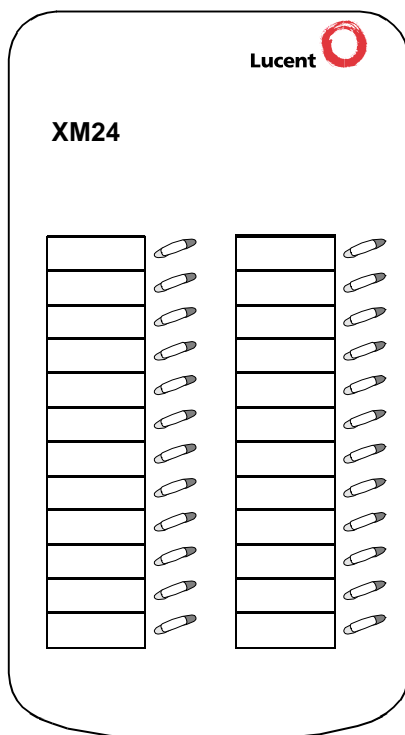

Figure 20-6. The XM24 Expansion Module

The XM24 Expansion Module is an optional device which can be connected to a 6416D+, 6416D+M, 6424D+, 6424D+M, or CALLMASTER V telephone to extend the number of call appearance and feature buttons available on each of these telephones.

**⇒ NOTE:**

Since the newer modular 6416D+M and 6424D+M have been built with a slightly different angle than the non-modular 6416D+ and 6424D+ telephones, there are also two versions of the XM24 Expansion Module

- The original XM24 meant for use with the 6416D+ and 6424D+  
(White = PEC: 33074, Comcode: 108023235  
Gray = PEC: 33076, Comcode: 108023243)

**20** Adjuncts

*The XM24 Expansion Module*

20-17

- The XM24 with a different angle, meant for the modular 6416D+M, 6424D+M, and CALLMASTER V  
(White = PEC: 33072, Comcode: 108554503  
Gray = PEC: 33071, Comcode: 108445511)

## Applications

---

The XM24 Expansion Module can be connected only to a 6416D+, 6416D+M, 6424D+, 6424D+M, or a CALLMASTER V telephone. These telephones have an "XM24" jack on the bottom of the set in order to allow connection with the expansion module.

## Physical Description

---

### Features

#### Buttons

The XM24 Expansion Module has 24 buttons arranged in two columns. Each of these buttons has a red and green light next to it. These buttons can be used for call appearances or features.

### Other Physical Features

#### Mounting

The XM24 Expansion Module is connected to a 6416D+, 6416D+M, 6424D+, a 6424D+M, or CALLMASTER V telephone with a D6AP-87 cord. This cord is plugged into the XM24 jack on the voice terminal and then plugged into the jack on the expansion module.

#### Color Options

This expansion module is available in gray or in white.

## Power

---

This expansion module requires auxiliary power.

- Suitable stand-alone power supplies include the 1151A1 and the 1151A2 with Battery Holdover, and the MSP-1.
- Suitable bulk power supplies are the 1145A and the 1145B1.

## Administering the XM24 Expansion Module

The 6416D+ or 6424D+ with connected expansion module are administered as itself only on DEFINITY ECS Release 6.1 and later. These telephones with or without an expansion module cannot be aliased as any other telephone.

**NOTE:**

The 6416D+M and CALLMASTER V are administered as a 6416D+; a 6424D+M is administered as a 6424D+.

On the first station administration screen of the 6416D+ or 6424D+, put a “Y” (for Yes) next to the “Expansion Module?” entry. On the last page of the administration screens, type the telephone or extension numbers or feature names next to the appropriate expansion module buttons in the following sequence.

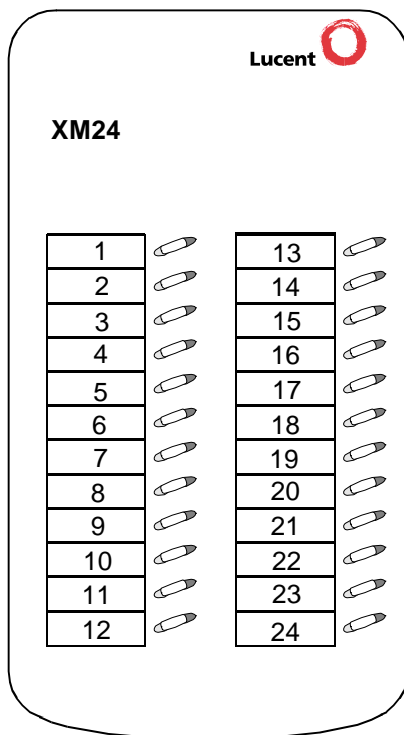

Figure 20-7. Button Numbering for Administering the XM24 Expansion Module

## XM24 Expansion Module PECs and Comcodes

The XM24 Expansion Module can be ordered with the following PECs and Comcodes:

- **The XM24 that can be used with the original non-modular 6416D+ and 6424D+:**

XM24-264 (White) Expansion Module  
PEC: 33074, Comcode: 108023235

XM24-264 (White) Expansion Module with 1151A Power Supply  
PEC: 33073  
Comcode for XM24 expansion module: 108023235  
Comcode for 1151A power supply: 107785693

**OR**

XM24-323 (Gray) Expansion Module  
PEC: 33076, Comcode: 108023243

XM24-323 (Gray) Expansion Module with 1151A Power Supply  
PEC: 33075  
Comcode for XM24 expansion module: 108023243  
Comcode for 1151A power supply: 107785693

- **The XM24 that can be used with the modular 6416D+M and 6424D+M:**

XM24 (White) Expansion Module  
PEC: 33072, Comcode: 108554503

**OR**

XM24 (Gray) Expansion Module  
PEC: 33071, Comcode: 108544511

- **2-foot D6AP-87 line cord**  
Comcode: 105644744

## Additional Documents

The following document is shipped with the expansion module. Additional copies are available from the BCS Publications Center for Lucent Technologies:

- *XM24 Expansion Module Instruction Manual*, 555-015-115

## The 100A Tip/Ring Module

---

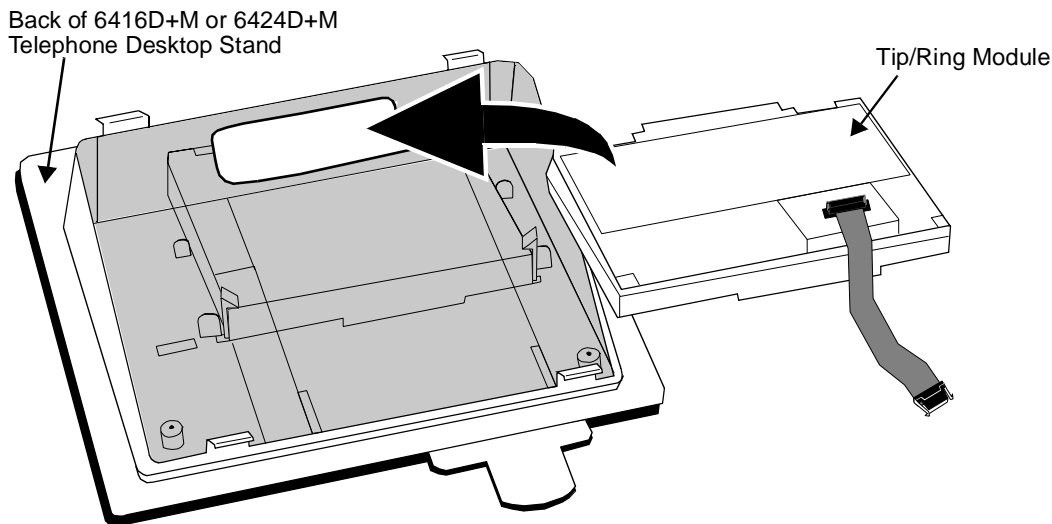

**Figure 20-8. The 100ATip/Ring Module Being Installed in the Desktop Stand of a 6416D+ or 6424D+ Telephone**

The Tip/Ring module can be installed in the desktop stand of the Modular 6416D+M (6416D02A) and 6424D+M (6424D02A) telephones to provide increased set functionality. Through a 6-position RJ11-type jack, the Tip/Ring module allows connection between these two 6400 Series telephone models and such analog adjuncts as answering machines, fax machines, modems, analog speakerphones, and TDD machines commonly used by the hearing impaired.

**⇒ NOTE:**

The Tip/Ring module is capable of supporting modem communication rates *up to* 33.6 Kbps. However, the maximum modem communication rate cannot be guaranteed because it is limited by the quality of the end-to-end channel. Also note that only DTMF (Dual Tone Multi-Frequency) dialing is supported by the Tip/Ring module.

This Tip/Ring module has been specially designed so that the voice quality of the analog adjunct connected to the module is equivalent to the performance of the analog adjunct when it is connected to an analog port on a DEFINITY switch.

**⇒ NOTE:**

This is true only for DEFINITY switches which use United States transmission levels.



20 Adjuncts

The 100A Tip/Ring Module

20-21

The module also has a special detector which senses if the analog adjunct is on-hook or off-hook, and the module, therefore, is able to disconnect the analog adjunct at the end of a call. However, whether the analog adjunct responds to a request to hang up depends on the design of the analog adjunct.

## Applications

---

The Tip/Ring module can ONLY be used with the Modular 6416D+M and 6424D+M telephones; that is, the telephone desktop stand must have a module opening in which the module can be installed. Once installed, the module has an analog adjunct jack to which the analog adjunct equipment can be connected.

The 6400 Series telephones have been developed to be used with the DEFINITY ProLogix system, but can also be used with the larger DEFINITY ECS Release 6.1 and later. These telephones, and thus the attached Tip/Ring module, CANNOT be used with any DEFINITY release prior to Release 6.1. For information on how the Tip/Ring module can be used with DEFINITY releases after Release 6.1, see "Considerations" below.

For more information about the 6400 Series telephones, see the material included in the **6400 Series Telephones** section earlier in this manual.

## Considerations

---

The manner in which the telephone and the analog adjunct interact depends on the switch release to which your telephone is connected. (Your system manager can give you more information about the switch release.)

- On DEFINITY Enterprise Communications Server (ECS) releases prior to Release 8.1, going back to Release 6.1, the analog adjunct shares the telephone line with the voice terminal. Therefore, while the telephone is being used, you *cannot* use the analog adjunct at the same time, or vice versa.
- On the DEFINITY ECS Release 8.1 and later, the telephone and the analog adjunct can be assigned separate telephone lines, and thus the voice terminal and analog adjunct can be used *simultaneously*.

## Physical Description

---

### Features

#### The Tip/Ring Module Option Switches

On the back of the 100A Tip/Ring module are two option switches shown below.

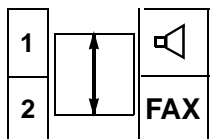

---

Figure 20-9. The Two Option Switches on the Tip/Ring Module



**The Option Switch on the Left, Labeled 1 and 2** — The option switch on the left allows you to choose the line that the connected analog adjunct will use.

- When the Option switch on the left is set to **1**, the telephone and the Analog adjunct *share the same line*. Therefore, only one device, the telephone handset OR the telephone built-in speakerphone OR the Analog adjunct can transmit on the same line at one time.

If the Tip/Ring device is installed on a 6416D+M or 6424D+M telephone connected to a DEFINITY switch prior to Release 8.1, you **MUST use Setting 1**; that is, you **CANNOT** use Setting 2.

- When the Option switch on the left is set to **2**, you can use a second line for transmission on the analog adjunct, a line that is independent of the telephone. When the second line is used, the telephone and the analog adjunct can use independent lines *simultaneously*.

If the Tip/Ring module is installed on a 6416D+ or 6424D+ telephone connected to a DEFINITY switch Release 8.1 or later, you can set the switch on the left to Setting **1** or **2**.

**The Option Switch on the Right, Labeled  and FAX** — If you selected Setting 1 on the left option switch (that is, the telephone and the analog adjunct use the same line), you **MUST ALSO SET** the option switch on the right, labeled  and FAX. This switch allows you to choose whether the analog adjunct, when active, will be interrupted when you pick up the handset or turn on the built-in speakerphone.

20 Adjuncts

The 100A Tip/Ring Module

20-23

Set the option switch on the right according to the analog device that is connected with the telephone.

- The  option means that the analog adjunct will be interrupted. **Use this option for adjunct speakerphones or answering machines.** If an attached speakerphone does not recognize a far end disconnect signal, you may have to manually turn off the speakerphone.
- The **FAX** option does not interrupt the analog adjunct. **Use this option for fax machines and modems.**

 **NOTE:**

The system manager may choose to administer a feature button on the telephone to provide you visible indication of the status of the second line used on Setting 2. Then, whenever the analog adjunct is active on the second line, the green light next to the button goes on.

Switch translation changes may be needed if the Tip/Ring module is optioned for Setting 2. See your system manager.

### Telephone Display Indications

The telephone display provides visible indication whether the module has power. A “+” appears in the upper right of the time/date display if there IS power to the module. A “-” appears on the time/date display if the module does NOT have power.

## Other Physical Features

### Required Cord

Either a D8W or a D2R line cord can be used to attach an auxiliary power supply to the Line jack on the telephone. If you have only a 2-wire line cord, replace it with the 8-wire cord that comes with the power supply. The auxiliary power supply can then be connected to the wall jack.

### Mounting

The 100A Tip/Ring module is connected to a 6416D+M or a 6424D+M telephone with a ribbon cable on the back of the module. This ribbon cable is then connected to the module jack on the back of the desktop stand.

### Color Options

The Tip/Ring module is available only in light gray.

## Power

---

The Tip/Ring module will work ONLY if it has auxiliary power. When the auxiliary power source is turned on, the Tip/Ring module will automatically power up. Suggested power supplies include:

- Suitable stand-alone power supplies include the 1151A1 and the 1151A2 with Battery Holdover.
- Suitable bulk power supplies are the 1145A and the 1145B1.



### NOTE:

If there is a power outage and the auxiliary power source shuts off, the telephone will continue to work, but the Tip/Ring module will NOT function.

## Administering the Tip/Ring Module

---

The 6416D+M and 6424D+M telephones are administered as a 6416D+ or 6424D+; however, they MUST BE connected to a DEFINITY ECS Release 6.1 (or later). In Native Mode the modular 6416D+M and 6424D+M telephones are administered through a digital line circuit card with a line number (with the usual three call appearances) assigned to the I-1 Channel. If the 6416D+M or 6424D+M is connected to a DEFINITY ECS Release 8.1 or later, a second line number can be administered through the same digital line card on the I-2 Channel, but this line number can only be used for analog adjuncts connected to the Tip/Ring module. This analog adjunct is assigned a private number, but can be used only for placing or terminating a call. It cannot be used for any other analog functions such as transferring a call or setting up a conference call. If a second line on the telephone is administered on the I-2-Channel (for analog equipment), type "analog" in the **Data Option** field on the administration screen.

On the first station administration screen of the 6416D+ or 6424D+, put a "Y" (for Yes) next to the "Tip/Ring Module?" entry.

## 100A Tip/Ring Module PECs and Comcodes

---

The 100A Tip/Ring Module can be ordered with the following PECs and Comcodes:

- **100A-266 Tip/Ring Module**  
(White) PEC: 3305-TR1, Comcode: 108332446  
**100A-266Tip/Ring Module with 1151A Power Supply**  
PEC: 3305-TRP
- **D2R-87 cord**  
Comcode: 105001861

**20** Adjuncts

*The 100A Tip/Ring Module*

20-25

## **Additional Documents**

---

The following document is shipped with the Tip/Ring module. Additional copies are available from the BCS Publications Center for Lucent Technologies:

- *The Tip/Ring Interface Module Installation and User Instructions, 555-233-707.*

## Headset Adapters

---

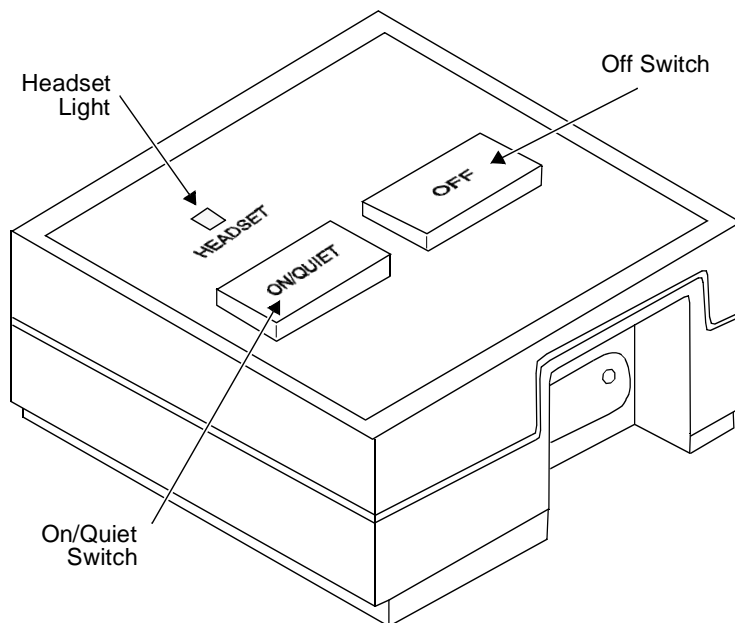

**Figure 20-10. The 500A Headset Adapter**

Two adapters are available to allow the use of standard headsets with voice terminals connected to the DEFINITY Communications System Generic 1, Generic 2, and Generic 3, the DEFINITY Enterprise Communications Server (ECS), System 75, and System 85. The 500A and the 502A Headset Adapters are identical in appearance, operation, and function but different in internal circuitry.

### Applications

---

The 500A and 502A headset adapters can be used with the DEFINITY G1, G2, and G3, the DEFINITY ECS, System 75, and System 85. The 500A adapter can be used with single-line Models 6402 and 6402D, 7103A, 7102A, and 7102A Plus and multi-appearance Models 6408, 6416D+, 6424D+, 7203H, 7205H, 7403D, 7405D, 7406D, 7406BIS, 7406 Plus, Enhanced 7407D, 7407 Plus, 7410D, 7410 Plus, 7434D, 7444, 8403, 8405, 8410, 8411, 8434, 8434DX, and 8102 voice terminals/telephones and the 6508, 7505, 7506, 7507, 8503T, 8510T, and 8520T ISDN terminals. The 502A adapter is intended for use with multi-appearance Models 7303S and 7305S voice terminals only.

## Physical Description

---

### Features

#### On/Quiet Switch

This dual-purpose switch is used to:

- Turn on the adapter connecting the headset to the voice terminal. Pressing the On switch is equivalent to going off-hook with the handset.
- Disable the transmitter of the headset temporarily for privacy.

#### Off Switch

- Turns off the adapter and disconnects the headset.
- Pressing the Off switch is equivalent to going on-hook with the handset.

#### Headset Jack

Used to connect the double phone plug of the headset.

#### Headset Light

Indicates when the headset is active.

### Other Physical Features

#### Cords

A modular cord is needed for connecting the headset adapter to the associated voice terminal. The cord carries audio signals between the adapter and the terminal and power for the adapter.

#### Mounting Options

The headset adapter is mounted close to its associated voice terminal.

#### Color Options

The 500A headset adapter is silver while the 502A is black.

### Power

---

The 500A Headset Adapter requires either AC or DC auxiliary power from one of the sources listed in the **Adjunct Power** section earlier in this manual. Power, from the source supply, is applied by way of the voice terminal's mounting cord and the adapter's connecting cord. The 502A draws its power from the system switch through the associated voice terminal.

## Considerations

---

The use of a headset provides hands-free terminal operation with more privacy than a speakerphone. A headset is especially convenient for users who must frequently type or look up information during calls.



**NOTE:**

A speakerphone and a headset adapter cannot be connected to the same voice terminal simultaneously.

## Typical Headsets

---

The following are typical headsets (consisting of either modular or plug prong base units and choice of headpieces) that can be connected to the 500A, the new 500A1, and the 502A adapters:

- **Plug Prong Base Unit**

PEC: 3122-010

Black



**NOTE:**

Plug Prong Base Units require a headset adapter.

- **Modular Base Unit**

PEC: 3122-020

Black/modular

- **Starset Headpiece**

PEC: 3122-030

Black/behind the ear

- **Supra Headpiece**

PEC: 3122-040

Black/over the ear

- **Mirage Headpiece**

PEC: 3122-050

Black/behind the ear

- **Supra Noise-Cancelling Headpiece**

PEC: 3122-060

Black/over the ear

## 500A and 502A Headset Adapter PECs

---

The 500A and 502A headset adapters can be ordered using the following PECs:

- **500A Headset Adapter** — PEC: 3122-001
- **502A Headset Adapter** — PEC: 3164-HFA



## The Z34A Message Waiting Indicator

---

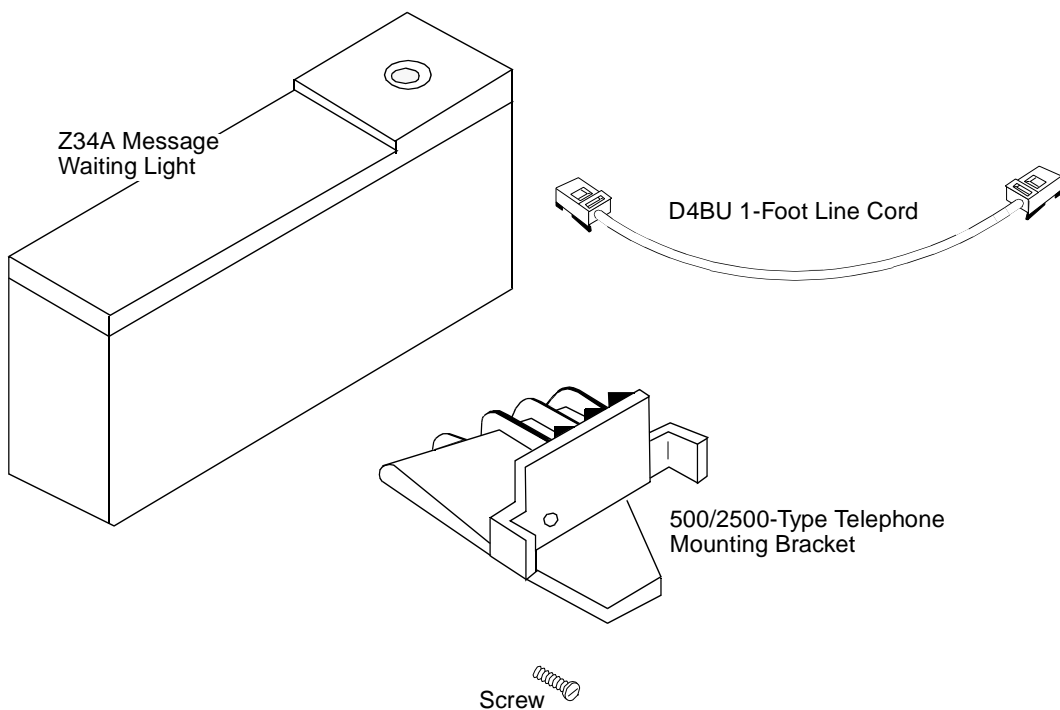

---

Figure 20-11. The Z34A Message Waiting Indicator

The Z34A Message Waiting Indicator is an adjunct that can be attached to analog voice terminals to allow these terminals to take advantage of the Leave Word Calling feature or message retrieval via AUDIX.

### Applications

---

The Z34A Message Waiting Indicator can be used with the DEFINITY Communications System Generic 1, Generic 2, and Generic 3, the DEFINITY ECS, System 75, and System 85. It is used with the Model 2500 voice terminal.

**20** Adjuncts

*The Z34A Message Waiting Indicator*

20-30

## **Physical Description**

---

### **Features**

#### **Light**

The Z34A contains a red light that flashes automatically when a message has been left for the terminal user.

### **Other Physical Features**

#### **Mounting Options**

The Z34A mounts on the right side of the voice terminal and is electrically connected between the terminal's line jack and the wall jack.

#### **Color Options**

The Z34A is available in ultra light gray only.

### **Power**

---

The Z34A Message Waiting Indicator receives its power from the same tip and ring leads as its associated voice terminal receives its power.

### **Message Waiting Indicator PECs**

---

The Z34A can be ordered using the following PEC:

- **Z34A Message Waiting Indicator** — PEC: 3152-004A

## The 4A, S101A, and S102A Speakerphones

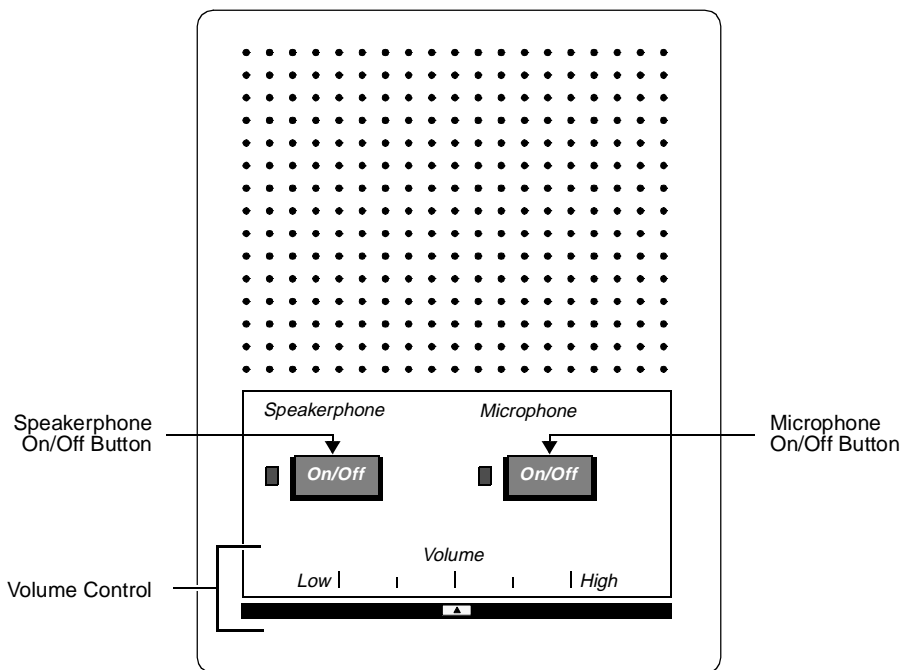

Figure 20-12. The S101A and S102A Speakerphones

Speakerphones are available for providing total voice terminal operation without the use of the handset. Turning on the speakerphone is equivalent to lifting the voice terminal handset when placing or answering a call. Turning off the speakerphone is equivalent to hanging up the handset. The microphone switch temporarily cuts off transmission to the distant party during a call.

### Applications

The speakerphones can be used with the DEFINITY Communications System Generic 1, Generic 2, and Generic 3, the DEFINITY ECS, System 75, and System 85. The S101A Speakerphone can be used with the single-line Models 7103A and 7102A and multi-appearance Models 7203H, 7205H, 7403D, 7405D, 7406D, 7406BIS, 7406 Plus, Enhanced 7407D, 7407 Plus, 7410D, 7410 Plus, 7434D, 7444, 8403, 8405, 8410, 8411, 8434, 8434DX, and 8102 voice terminals/telephones, and the 6508, 7505, 7506, 7507, 8503T, 8510T, and 8520T

**20** Adjuncts

*The 4A, S101A, and S102A Speakerphones*

20-32

ISDN terminals. The S102A is intended for use with multi-appearance Models 7303S and 7305S voice terminals only. The 4A speakerphone is used only with the basic 2500-series terminals and METs on an "in place" basis.

## **Physical Description**

---

### **S101A and S102A Speakerphones Features**

#### **On/Off button for Speakerphone**

There is a nonlocking On/Off button and adjacent green light for the speakerphone.

#### **On/Off button for Microphone**

There is also a nonlocking On/Off button and adjacent green light for the microphone.

#### **Sliding volume control**

The volume of the speaker is controlled by this slide switch.

#### **Cord**

A modular cord for connecting the speakerphone to the associated voice terminal; the cord carries audio signals between the speakerphone and the terminal and power for the speakerphone.

#### **Color Options**

The S101A and S102A speakerphones are silver.

### **4A Speakerphone Features**

#### **ON or QUIET button**

This nonlocking button turns the speakerphone on (same as going off-hook). This button is also used to place the speakerphone in a listen-only mode.

#### **OFF button**

This locking button turns the speakerphone off (same as going on-hook).

#### **Volume**

The volume of the speaker is controlled by this knob.

#### **Color Options**

The 4A Speakerphone is available in avocado, black, white, beige, and ivory.

## Power

---

The S101A and S102A Speakerphones require either AC or DC auxiliary power from one of the sources listed in the **Adjunct Power** section earlier in this manual. Power from the source supply is applied by way of the voice terminal's mounting cord and the speakerphone's connecting cord. The S102A draws its power from the system switch through the associated voice terminal; it does not require an auxiliary power source.

The 4A Speakerphone requires auxiliary power from one of the sources listed in the **Adjunct Power** section earlier in this manual. The power from the source supply is applied to the loudspeaker set and the transmitter through an adapter or connecting block provided with the 4A Speakerphone.

## Considerations

---

A speakerphone and a headset adapter *cannot* be connected to the same voice terminal simultaneously.

## Speakerphone PECs

---

The speakerphones can be ordered by using the following PECs:

- **S101A Speakerphone** — PEC: 31711 (not orderable)
- **S102A Speakerphone** — PEC: 31730 (not orderable)
- **4A Speakerphone**
  - (Avocado) — PEC: 3120-02W-COL01
  - (Black) — PEC: 3120-02W-COL09
  - (White) — PEC: 3120-02W-COL10
  - (Beige) — PEC: 3120-02W-COL11
  - (Ivory) — PEC: 3120-02W-COL12

## The S201A and S202A Speakerphones

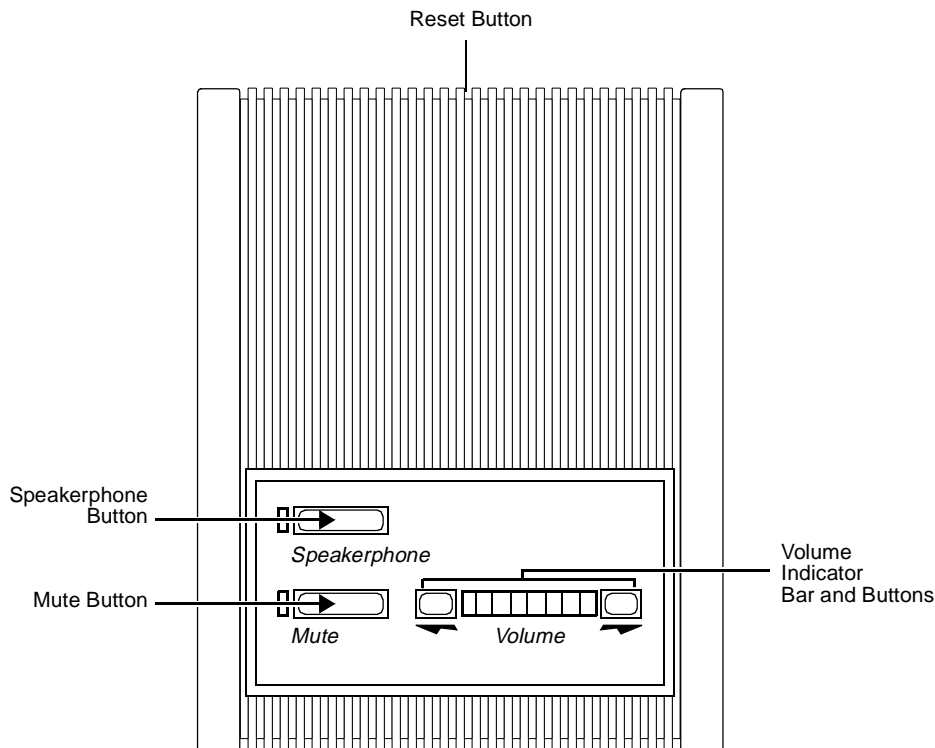

Figure 20-13. The S201A and S202A Speakerphones

The S201A and S202A speakerphones are available for providing total voice terminal operation without the use of the handset. Turning on the speakerphone is equivalent to lifting the voice terminal handset when placing or answering a call. Turning off the speakerphone is equivalent to hanging up the handset. The Mute switch temporarily cuts off transmission to the distant party during a call. The S201A and S202A speakerphones automatically adapt to room acoustics, thereby dramatically improving the sound quality.

### Applications

These speakerphones can be used with the DEFINITY Communications System Generic 1, Generic 2, and Generic 3, the DEFINITY ECS, System 75, and System 85. The S201A Speakerphone can be used with the single-line Models 7103A, 7102A, and 7102 Plus and multi-appearance Models 7203H, 7205H, 7403D, 7405D, 7401 Plus, 7406D, 7406BIS, 7406Plus, Enhanced 7407, 7407 Plus, 7410D, 7410 Plus, 7434D, 7444, 8403, 8405, 8410, 8434, 8434DX, and 8102

**20** Adjuncts

*The S201A and S202A Speakerphones*

20-35

voice terminals/telephones, and the 7505, 7506, and 7507, 8503T, 8510T, and 8520T ISDN terminals. The S202A is intended for use with multi-appearance Models 7303S and 7305S voice terminals only.

## **Physical Description**

---

### **Features**

#### **Speakerphone button**

This locking button turns the speakerphone on and off. When the green light is on, the speakerphone is on.

#### **Mute button**

This nonlocking button and its red light are for the microphone. When the light is on, the microphone is muted.

#### **Volume control**

The volume of the speaker is controlled by the volume buttons associated with the arrows. The lights on the volume indicator bar shows the selected volume level.

#### **Reset button**

The RESET button automatically performs an acoustic test of the environment.

### **Other Physical Features**

#### **Cord**

A modular cord connects the speakerphone to the associated voice terminal. This cord carries audio signals between the speakerphone and the terminal and power for the speakerphone.

#### **Jack**

A modular jack is located on the rear of the speakerphone.

#### **Color Options**

The S201A and S202A speakerphones can be misty cream or black.

20 Adjuncts

The S201A and S202A Speakerphones

20-36

## Power

---

The S201A Speakerphone requires either AC or DC auxiliary power from one of the sources listed in the **Adjunct Power** section earlier in this manual. Power from the source supply is applied by way of the voice terminal's mounting cord and the speakerphone's connecting cord. A 24 volt, 7.5 Va AC transformer with a 400 B2 adapter is packed with the S201A Speakerphone. The transformer may be located up to 125 feet from the speakerphone. The S202A Speakerphone draws power from the associated telephone.



**WARNING:**

*Do not use the 2102D wall transformer due to incorrect voltage.*

## Considerations

---

A speakerphone and a headset adapter *cannot* be connected to the same voice terminal simultaneously.

## S201A and S202A Speakerphone PECs

---

The speakerphones can be ordered by using the following PECs:

- **S201A Speakerphone** — PEC: 3152-007A
- **S202A Speakerphone** — PEC: 3152-008A



## The S203A Speakerphone

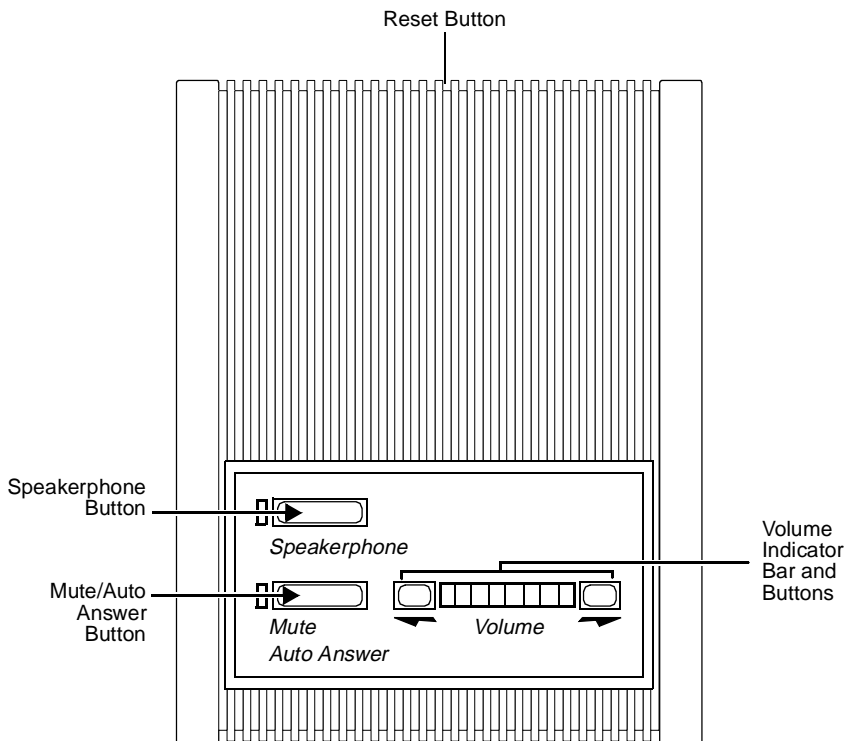

Figure 20-14. The S203 Speakerphone

The S203A Speakerphone is an analog speakerphone with Auto-Answer and Automatic Disconnect capabilities. The S203A can be used in conjunction with any single-line analog set (an additional 267A2 bridging adapter is included for this arrangement) or as a stand-alone unit. When it is used in a stand-alone operation, the S203A provides no dialing functionality. When the Auto-Answer feature is enabled, an incoming call will cause the S203A to automatically go off-hook and emit a special tone that is heard by both the calling and called parties. This tone indicates that the call has been automatically answered. The S203A Speakerphone automatically adapts to room acoustics, thereby dramatically improving the sound quality.



**NOTE:**

This speakerphone is available with a wall-mounting bracket.

## Applications

---

The S203A Speakerphone can be used with the DEFINITY Communications System Generic 1, Generic 2, and Generic 3, the DEFINITY ECS, System 75, and System 85. Its Auto-Answer and Auto-Disconnect capabilities make it very suitable for environments where hands-free mode of answering is desirable. Such scenarios include hospital emergency rooms, laboratories, nursing homes, storerooms, and warehouses.

## Physical Description

---



### NOTE:

The following dimensions are approximate.

## Dimensions

Width = 4-3/4 inches

Depth (front to back) = 6-1/8 inches

Height = 2-1/4 inches

## Features

### Speakerphone with light

This non-locking switch turns the S203A on and off. The green light goes on when the speakerphone is on.

### Mute/Auto Answer with light

This button toggles between the Mute and Auto-Answer features. When the speakerphone is on, the button functions as a Mute button; the red light is on. When the speakerphone is off, the button functions as the Enable/Disable button for the Auto-Answer feature; when the Auto-Answer feature is enabled, the light flashes.

### Two Volume buttons

These two nonlocking buttons are labeled with arrows. Between these two buttons is a row of 10 green lights that indicate the loudness. When the S203A is on, each depression of an up/down button causes the loudspeaker volume to be raised or lowered and an light on the right end of the string of illuminated lights to be turned on or off.

## Recalibrate button

The Recalibrate button is located on the rear of the S203A Speakerphone. When this button is pressed (or when the S203A is powered up), the S203A executes an acoustical calibration of its environment. It is necessary to recalibrate the S203A each time it has been moved or its surroundings have been altered.

## Other Physical Features

### Jacks

The S203A Speakerphone has a 8-pin modular phone connector on the rear.

### Color Options

The S203A Speakerphone can be misty cream or black.

### Mounting Options

The S203A Speakerphone is desk mounted.

## Power

---

The S203A Speakerphone is powered from an external AC transformer through two pins of the eight pin jack on the rear of the unit. A PS3081096 Wall transformer with a 304B adapter is provided with the S203A.

### NOTE:

The S203A requires AC power. DO NOT use the 2012D Wall transformer or any DC powering arrangement.

## Bridging

---

Software bridging (that is, translating an extension number to appear on both an analog and digital port) *is not recommended* when using the S203A Speakerphone because it directly affects the functionality and operations of both the telephone and the S203A. Automatic disconnect may not work as documented. Transferring a call from one digital phone that has an S203A as an adjunct, to another digital phone may not work as documented.

**20** Adjuncts

*The S203A Speakerphone*

20-40

## **FCC Registration**

---

The S203A Speakerphone is FCC registered (AS5USA-61382-SP-N Ringer Equivalence 0.4A, 0.9B USOC Jack RJ11C, RJ11W).

## **S203A Speakerphone PECs**

---

The S203A Speakerphone can be ordered with the following PEC:

- **S203A Speakerphone** — PEC: 3131-008

## The 107-Type Loudspeaker

---

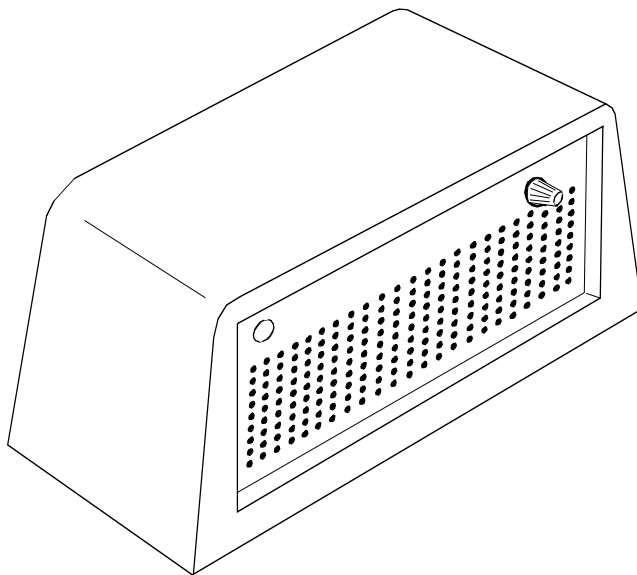

---

**Figure 20-15. The 107-Type Loudspeaker**

The 107-Type Loudspeaker amplifies the received voice signal. This allows the user to hear better in a noisy environment.

### Applications

---

The loudspeaker can be used with the DEFINITY Communications System Generic 1, Generic 2, and Generic 3, the DEFINITY ECS, System 75, and System 85. It is used only with 2500-type voice terminals on “in place” basis. It is particularly useful in a conference room or noisy room.

## Physical Description

---

### Dimensions



**NOTE:**

The following dimensions are approximate.

Width = 5-3/4 inches

Depth (front to back) = 3-3/4 inches

Height = 4 inches

### Features

#### Volume control

The loudspeaker is equipped with a rotary volume control.

#### ON/OFF switch

The ON/OFF switch turns the loudspeaker on and off when placed in the appropriate setting.

### Power

---

The 107-Type Loudspeaker requires an external AC or DC power source. This power may be provided by an 2012D Transformer, 18-volt AC terminals of an available power plant, or a 24-volt DC key system battery.

## The 7404D (Voice Terminal) Messaging Cartridge

---

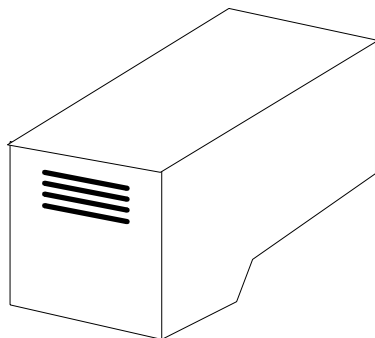

---

Figure 20-16. The Messaging Cartridge

This Messaging Cartridge adjunct can be added to a 7404D Voice Terminal to provide displays on an associated data terminal. The messaging cartridge plugs into the bottom of the 7404D Voice Terminal. The basic messaging cartridge generates displays of call-related and personal-service information only.



**NOTE:**

The 7404D Messaging Cartridge was discontinued in July 2090.

### Applications

---

The messaging cartridge is used with a 7404D voice terminal that is equipped with a data terminal. The 7404D and messaging combination can be used with a DEFINITY Communications System Generic 1, Generic 2, and Generic 3, the DEFINITY ECS, System 75, or System 85.

20 Adjuncts

*The 7404D (Voice Terminal) Messaging Cartridge*

20-44

## Considerations

---

A selection of the following display functions must be assigned to letter keys on the keyboard of the associated data terminal:

- Normal Mode
- Inspect
- Message Retrieval
- Next
- Make Call
- Delete Message
- Date/Time

## Messaging Cartridge PECs

---

The messaging cartridge attached to the 7404D voice terminal was ordered using the following PEC:

- **Messaging Feature Cartridge** — PEC: 31810



## The 2870A1 Automatic Dialer

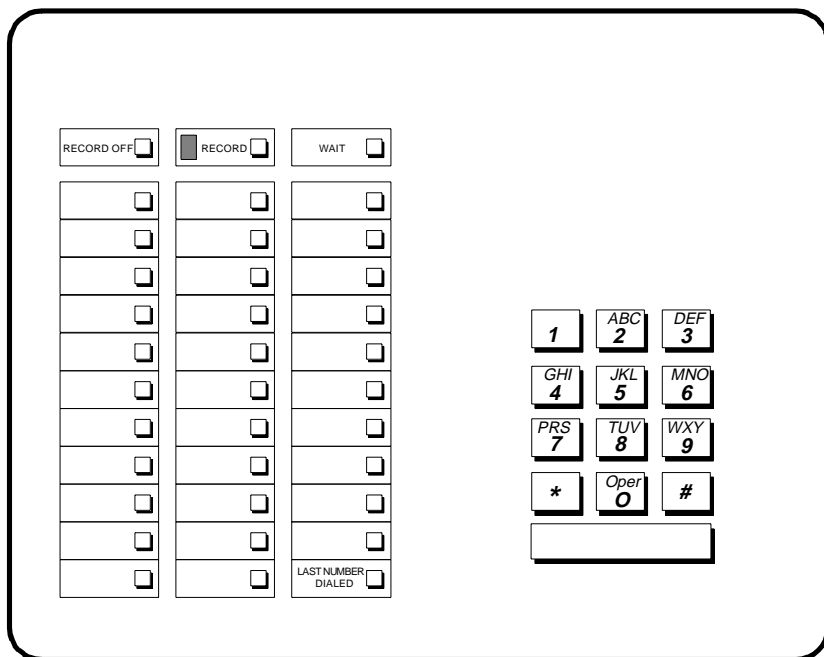

Figure 20-17. The 2870A1 Automatic Dialer

The 2870A1 Automatic Dialer is an optional add-on adjunct for a MET set that is provided on an “in place” basis only. The dialer provides the capability to record and automatically dial 31 numbers of up to 15 digits each. It also provides last number dialed (manually) memory and the capability to pause for subsequent dial tones during automatic dialing (WAIT input).

### Applications

The automatic dialer can be used with the DEFINITY Communications System Generic 1, Generic 2, and Generic 3, the DEFINITY ECS, System 75, and System 85. It is particularly useful for applications where several numbers must be repeatedly dialed.

## Physical Description

---

### Features

#### Programmable buttons

The automatic dialer has 31 buttons on which telephone numbers of up to 15 digits can be stored for one button dialing.

#### Four Fixed function buttons

- Record Off
- Record (Equipped with an Indicator)
- Wait
- Last Number Dialed

### Other Physical Features

#### Dial pad

The automatic dialer is equipped with a 12-button touch-tone dial pad.

### Power

---

The 2870A1 Automatic Dialer requires auxiliary power from an external source. Refer to the **Adjunct Power** section earlier in this manual for the recommended power supply.

### Automatic Dialer PECs

---

The 2870A1 Automatic Dialer can be ordered using the following PECs:

- **2870A1 Automatic dialer**  
(Silver)— PEC: 3113-030FPC01  
(Teak)— PEC: 3113-030FPC02  
(Walnut)—PEC: 3113-030FPC03

## Data Modules

# 21

---

This section describes the devices that provide a data communications interface. Information on the data modules and other related data equipment used with the DEFINITY Communications System Generic 1, Generic 2, and Generic 3, the DEFINITY ECS, System 75, and System 85 is provided here. The following devices described in this section provide data interface functions such as modems, protocol converters, and data units.

- 7400A Data Module
- 7400B and 7400B Plus Data Module
- 7400D Low-Speed Asynchronous Data Module
- 8400B Plus Data Module
- 7500B Data Module
- ISDN Asynchronous Data Module (ADM)
- Digital Terminal Data Module (DTDM)
- Z702AL1 Data Service Unit (DSU)
- 703A Data Service Unit (DSU)
- DEFINITY High Speed Link (HSL)
- Processor Data Module (PDM)
- Trunk Data Module (TDM)

- Modular Processor Data Module (MPDM)
- Modular Trunk Data Module (MTDM)
- 3270 Data Module
- Asynchronous Data Unit (ADU)
- Multiple Asynchronous Data Unit (MADU)
- DCIU Interface Units
- 2500-Series Data Service Unit (DSU)

## The 7400A Data Module

---

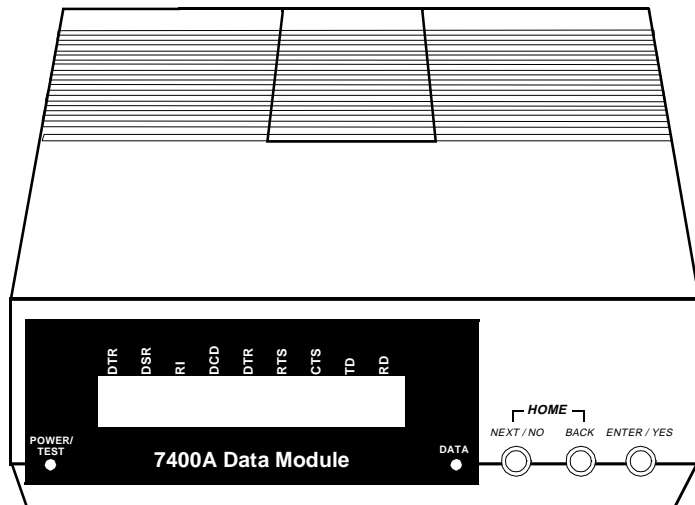

Figure 21-1. The 7400A Data Module

The 7400A Data Module is a full duplex asynchronous data module designed to replace both the TDM (MTDM) and PDM (MPDM) for asynchronous applications. The 7400A provides a DCP interface to the PBX and an RS-232-D (formerly RS-232-C) interface to a DTE such as host computers, personal computers, and terminals or DCE modems in external modem pool installation.

### Applications

---

The 7400A data module can be used with the DEFINITY Communications System Generic 1, Generic 2, and Generic 3, the DEFINITY ECS, System 75, and System 85. It can be used in the modem pooling feature or for host access.

## Physical Description

---

### Dimensions



**NOTE:**

The following dimensions are approximate.

Width = 7 inches

Depth (front and rear) = 8-3/4 inches

Height = 1-3/4 inches

### Features

#### Lights

- **POWER/TEST light** — This red light goes on when the 7400A data module is on and flashes during all tests.
- **DATA light** — This green light goes on during a data call and flashes when receiving an incoming call.

#### Display

The 16-character LCD display shows the status, option information, test information, and also information about the RS-232-D interface of the data module.

#### NEXT/NO, BACK, and ENTER/YES buttons

These buttons are used to view and set data communication options and functions, adjust the contrast of the display, and to conduct tests.

### Other Physical Features

#### Jacks

The 7400A data module is equipped with the following jacks.

- **PORT 1** (EIA RS-232-C or -D)
- **PHONE** (not used)
- **LINE** (to switch) (RJ-45)
- **POWER**

## Mounting Options

The 7400A data module can be configured as a stand-alone unit or in a multiple-mount housing. (The multiple-mount housing *must be used* if D-lead modems are used in the modem pool. The multiple-mount can also be used to support Hayes-compatible modems.)

## Color Options

The 7400A Data Module is available in misty cream only.

## Tests

---

The 7400A data module supports the following test and maintenance features:

- Self-test
- Local loopback and remote loopback
- Local Loop self test and remote loop self test
- DCP looparound
- Maintenance activate
- Make busy
- Manual on-hook/off-hook

## Capabilities

---

The basic features and capabilities of the 7400A data module are:

- DCP mode 2 operation only
- Full-duplex, 10-bit start/stop, asynchronous operation
- Asynchronous data rates of 0.3, 1.2, 2.4, 4.8, 9.6, and 19.2 kbps
- Even, odd mark, and space parity options
- Automatic answer option
- Signal loss disconnect option
- Autobaud
- Autoparity
- Long-break and triple-break disconnect options

Data features for modem pooling applications include:

- EIA RS-232-D DTE interface, enhanced with CI2 and CH2 leads
- Interface for D-lead control modems
- Interface for Hayes-compatible modems

**21 Data Modules**

*The 7400A Data Module*

21-6

Data features for host or terminal applications include:

- EIA RS-232-D DCE interface
- Keyboard dialing and Hayes user interface emulation option
- Answer only
- Cyclic Ring-indicator option
- Ignore DTR input option

**Power**

---

The stand-alone 7400A data module operates with power from a WP90110 L7 AC power converter. This is a modular AC to DC adapter that is normally plugged into a wall outlet. The Z77A Data Mounting has a built-in power supply for powering data modules in the multiple-mount arrangement.

**Considerations**

---

The 7400A data module will NOT support the following:

- Linked operation with associated DCP telephone
- Synchronous Data transmission
- Asynchronous User Interface (AUI)
- DCP Mode 0, 1, 3, and Mode 2/3 adaptive

**FCC Registration**

---

No digital phones or data modules are FCC registered. The 7400A data module meets Part 15 Class A requirements and is labeled as such.

**7400A Data Module PECs**

---

The 7400A data module can be ordered using the following PECs:

- 7400A Data Module — 2171-ADM
- Stand-alone Power Supply — 21625
- 7400A Multiple Mounting — 21626



21 Data Modules

*The 7400A Data Module*

21-7

## **Additional Documents**

---

The following documents contain additional information relating to the 7400A data module:

- *7400A Data Module User's Manual*, 555-020-706
- *7400A Data Module Installation Guide*, 555-020-708
- *System 85 Application Notes for External Modem Pooling*, 555-109-005
- *System 85 Application Notes for Host Access Operation*, 555-109-004
- *System 75 Application Notes for External Modem Pooling*, 555-209-016
- *System 75 Application Notes for Host Access Operation*, 555-209-015

## The 7400B and 7400B Plus Data Module

---

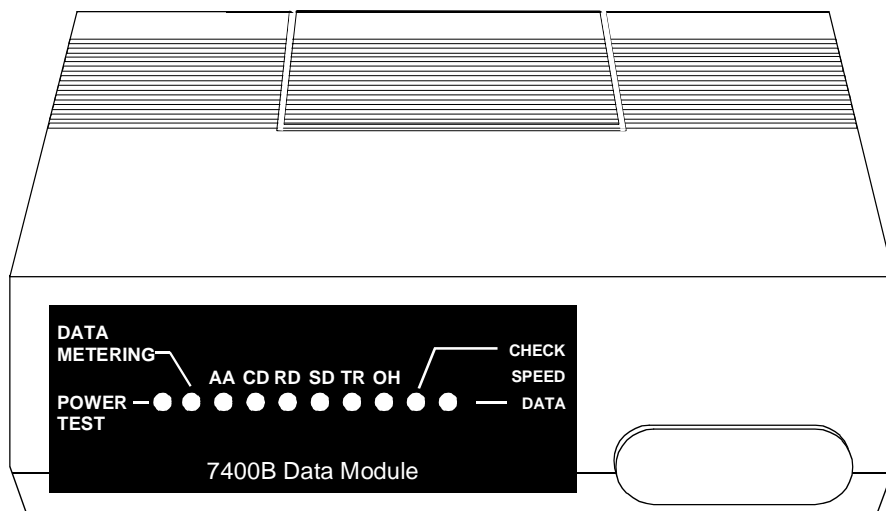

Figure 21-2. The 7400B Plus Data Module

The 7400B and 7400B Plus Data Modules are full-duplex asynchronous, Hayes-compatible data modules that provide for simultaneous voice-data communications at the desk top over standard twisted pair wiring. The 7400B data module has been discontinued; however, the 7400B Plus data module has all of the basic characteristics of the 7400B, with the following added benefits:

- Supports the semicolon dial modifier, which enables an automatic return to the command mode after dialing a data call
- Offers a storable S7 register, which supports increased call set-up time
- Offers the voice dial capability, which provides the ability to dial a voice call from the PC package in the attached PC

Both of these data modules replace the existing PDM (MPDM) for asynchronous communication, DTTM, and data stands for 7406D and 7407D voice terminals (703A DSU and 702AL1) and the 7404D integrated voice/data phone.

### ⇒ NOTE:

If you have a 7400B data module and want to have the voice dial feature, you can upgrade your current 7400B with a D-kit (Comcode: 106414543) orderable through the National Parts Sales Center at 1 800 222-PART.

**21** Data Modules*The 7400B and 7400B Plus Data Module*

21-9

In the linked mode, the 7400B and 7400B Plus data modules provide for simultaneous voice data communications over standard twisted pair wiring. In this mode, the 7400B and 7400B Plus data modules can be used with all DCP voice terminals to provide data service. The 7400B Plus provides the voice dial feature for all DCP voice terminals *except* the following:

- 7403D voice terminal (all models)
- 7404D voice terminal (all models)
- 7405D voice terminal (all models)
- 7407D01A voice terminal

## Applications

---

The 7400B and 7400B Plus data modules can be used with the DEFINITY Communications System Generic 1, Generic 2, and Generic 3, the DEFINITY ECS, System 75, and System 85. The data modules are used as a DCE for host access services, PC, or terminal (DTE) connectivity (see Figure 21-3).

Figure 21-3 shows a diagram of the connections between the 7400B or 7400B Plus and the data terminal, the digital voice terminal, and the switch.

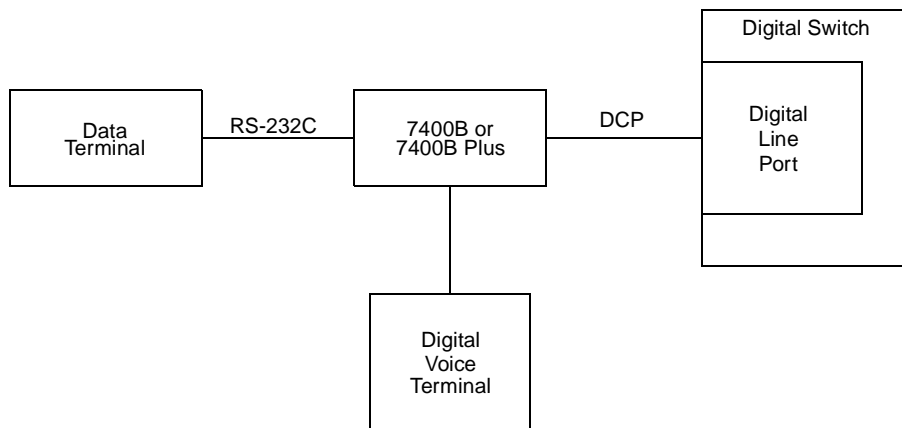

---

**Figure 21-3.** A Block Diagram of the 7400B Interface

21 Data Modules

*The 7400B and 7400B Plus Data Module*

21-10

## Physical Description

---

### Dimensions



**NOTE:**

The following measurements for the 7400B and 7400B Plus data module are approximate.

Width = 7 inches

Depth (front and rear) = 8-3/4 inches

Height = 1-3/4 inches

### Features

#### Lights

- **POWER/TEST light** — The red POWER/TEST light goes on when AC power is supplied to the 7400B or 7400B Plus data module and flashes during all tests. This light, together with the DATA light, also flashes if there is a DCP line problem.
- **DATA light** — The green DATA light goes on during a data call. This light, together with the POWER/TEST light, flashes if there is a DCP line problem.
- **Other lights** — The eight other lights show the RS-232 status information, the status of two options, and call status information. These lights are red.

### Other Physical Features

#### Jacks

The 7400B and 7400B Plus data modules are equipped with the following jacks:

- Port 1 (RS-232-C or -D)
- PHONE (to voice terminal) (RJ-45)
- LINE (to switch) (RJ-45)
- POWER

#### Mounting Options

The 7400B and 7400B Plus data modules can be desk-mounted as a stand-alone unit.

#### Color Options

The 7400B and 7400B Plus data modules are available only in misty cream.

21 Data Modules

*The 7400B and 7400B Plus Data Module*

21-11

## Tests

---

The 7400B and 7400B Plus data modules support the following test and maintenance features:

- Local Loopback and Remote Loopback
- Local Loopback Self Test and Remote Loop Self Test
- DCP Looparound
- Self-Test
- Make Busy on Local Loop

## Capabilities

---

The 7400B and 7400B Plus data modules have the following basic features and capabilities:

- DCP mode 2 operation only
- Full-duplex, 10-bit start/stop, asynchronous operation
- Asynchronous data rates of 0.3, 1.2, 2.4, 4.8, 9.6, and 19.2 kbps
- Even, odd, mark, and space parity options
- Autobaud and autoparity
- Linked operation with the associated DCP voice terminal
- Data metering — Data metering allows the data module and associated terminal to operate at higher speeds than the far-end data point.
- Supports the semicolon modifier which enables an automatic return to the command mode after dialing a data call (for 7400B Plus).
- Voice Dial (for 7400B Plus) — This feature allows you to initiate voice calls from your PC using the dial command "atdp number." These calls must be terminated manually, however.
- Speakerphone Activation before Dialing (for 7400B Plus) — For terminal dialed voice calls, you can delay speakerphone activation until after a call is dialed. You would not hear touch tones or dial tone in this case.
- Wait Time for Carrier (for 7400B Plus) — The number stored in the S7 register establishes the time the 7400B Plus data module will wait for call set up to be completed. This number can be set for any value up to a maximum of 255 seconds (with a default to 60 seconds).

Data features for host or terminal applications include:

- EIA RS-232-D DCE interface
- Hayes SMARTMODEM 2400™ user interface emulation

**21** Data Modules*The 7400B and 7400B Plus Data Module*

21-12

**Power**

---

The stand-alone 7400B and 7400B Plus data modules operate with power from a WP91508L5 AC power converter. This is a modular AC to DC adapter that is normally plugged into a wall outlet. The data module allows phantom power to be transmitted to the attached DCP voice terminal even if AC power to the data module is interrupted.

**Setting Options**

---

After removal of the top access panel of the data module during installation, it is important to verify that the eight option switches are set to provide the desired features.

- **SW1-1—With/Without Telephone Option**

This switch must be set to ON for operation *without* an associated telephone. This switch must be set to OFF for operation *with* an associated telephone.

- **SW1-2 (Not used)**

- **SW1-3 (Not used)**

- **SW1-4 (Not used)**

- **SW1-5—Data Metering Option**

When this switch is set to ON, the data module and associated terminal can operate at higher speeds than the far-end data point. This switch is usually set to OFF.

- **SW1-6—Suppress Touch-Tone/Dial Tone (for 7400B Plus)**

Leave this switch set to OFF if the user prefers listening to Touch-Tones as voice calls are being dialed. Set the switch to ON if the user wants to suppress Touch-Tones. If the user is using a speakerphone, ringing will be heard after the call has been made.

- **SW1-7—Speakerphone Enable/Disable Option (for 7400B Plus)**

Leave this switch set to OFF if the user wants the speakerphone to turn on automatically when the terminal is used to make a voice call. Set the switch to ON if there is no speakerphone or if the user wants to disable the speakerphone automatic activation feature.

- **SW1-8—Make Busy on Local Loop Option**

This switch should be set to ON if the user wants the telephone line to appear busy when the local loopback test feature is used to check the interface between the data module and the terminal.

21 Data Modules

The 7400B and 7400B Plus Data Module

21-13

## Notes for Use with PC Packages

---

The 7400B Plus voice and data feature has been tested with the following PC communication packages:

- CARBON COPY Plus™ V5.1
- Crosstalk®- XVI V3.71
- Crosstalk Mk.4 V1.1
- Hot Line V2.2 (voice dialing packages)
- HyperACCESS® V3.32
- MicroPhone V1.5 (MacIntosh package)
- PC TOOLS Deluxe V6 (voice dialing packages)
- Procomm Plus® V1.1B
- Relay Gold® V3.0
- SideKick® V1.5 and SideKick Plus (voice dialing packages)
- Smartcom™ II V2.2
- Smartcom II V3.1
- Smartcom III V1.1
- Smarterm 240 V3.0a
- Terra Nova® V1.1.1
- White Knight V11 (MacIntosh package)

For those PC packages used to dial voice calls, the modem configuration must be set to PULSE (P) (even though the 7400B Plus will use Touch-Tone for voice calls). If given a choice, set modem type to HAYES.

### NOTE:

While the 7400B Plus supports simultaneous voice and data, the packages listed here support *alternate voice/data dialing only*. Voice dialing packages interfere with data operation by remapping the COM port or by hanging up the data call.

You *can* dial a data call while on a voice call. In all cases, the linked telephone will work.

## FCC Registration

---

These data modules are not FCC registered. The 7400B and 7400B Plus data modules meet Part 15 Class A requirements and are labeled as such.

21 Data Modules

*The 7400B and 7400B Plus Data Module*

21-14

## 7400B Data Module PECs

The 7400B and 7400B Plus data modules can be ordered using the following PECs:

- **7400B Plus Data Module**

PEC: 2172-101

Comcode: 106545841



**NOTE:**

The 7400B Plus data module comes with a stand-alone power supply.

## Additional Documents

The following documents contain additional information relating to the 7400B and 7400B Plus data modules:

- *7400B Data Module User's Guide, 555-020-707*
- *7400B Plus Data Module User's Guide, 555-020-710*
- *DEFINITY Communications System Generic 1 and System 75 R1V2 Through R1V3 7400B Data Module Application Notes, 555-209-017*
- *7400B Data Module PC Applications Guide, 555-035-203*



## The 7400D Low-Speed Asynchronous Data Module

---

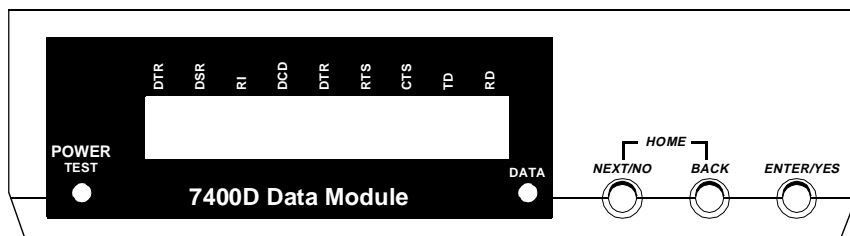

Figure 21-4. The 7400D Data Module

The 7400D Data Module is a full-duplex, 4-wire synchronous data module for the DCP environment and is designed to work where the integration of voice and data is not required. The 7400D supports synchronous connections at speeds up to 19.2 Kbps via an EIA-232-D interface.

### NOTE:

This data module is configured for an Answer-Only-type interface. You CANNOT originate calls with this data module.

The 7400D data module is intended for use in a switch room to support the AUDIX systems, the Call Management System (CMS), and the Distributed Communications System (DCS) low speed synchronous data applications, connections in which the MPDM was formerly used.

## Applications

---

The 7400A Data Module can be used with the DEFINITY Communications System Generic 1, Generic 2, and Generic 3, the DEFINITY ECS, System 75, and System 85.

## 21 Data Modules

### *The 7400D Low-Speed Asynchronous Data Module*

21-16

## Physical Description

---

### Dimensions

The following dimensions are approximate.

Width = 7 inches

Depth (front and rear) = 8-3/4 inches

Height = 1-3/4 inches

### Features

#### Front Panel

The front panel is comprised of:

Two LEDs, one red and one green

- POWER/TEST light — This red light goes on when the 7400D data module is on, and it flashes during all tests
- DATA light — This green light goes on when a data call is in progress, and it flashes when receiving an incoming call. This light also flashes synchronously with the red light indicating that the connection to the PBX is lost.
- A single line, 16-character LCD display — The 16-character LCD display first shows a start-up sequence consisting of self-test results, hardware configuration, software release and version, and copyright information. Following start-up, the **Home** screen is displayed.
- Three non-locking push-buttons
  - NEXT/NO button — This button is used to scroll forward through the menu and/or reject the function displayed. By keeping this button depressed, you are able to quickly scroll through menu items.



#### NOTE:

When you press NEXT/NO and BACK simultaneously, you are automatically returned to the **Home** screen from many menus. However, do not press these two keys simultaneously while changing option values. If this is done, rather than returning you to the **Home** screen, the system queries if you want to save the changes you have made.

## 21 Data Modules

### *The 7400D Low-Speed Asynchronous Data Module*

21-17

- BACK button — This button is used to scroll backward through the menu. By keeping this button depressed, you are able to quickly scroll back through menu items.
- ENTER/YES button — This button is used to set an option or execute the function displayed.

### **The Main Menu**

The Main Menu has several levels of options and suboptions. By pressing NEXT/NO, you are able to scroll through the entire first level to view each option shown in the flowchart below.

After scrolling to the desired Main Menu option and selecting it by pressing ENTER/YES, you are now one level deeper within the options, and a suboptions choice is presented to you.

## **Other Physical Features**

### **Jacks**

The 7400D data module is equipped with the following jacks:

- PHONE — not used by the 7400D
- LINE — accepts one end of the D8W telephone cord that connects the data module and the PBX wall jack
- POWER — accepts the output cable of the separate power supply unit used with the 7400D
- PORT 1 — accepts a male plug from the EIA-232-D cable that connects between the data module and associated equipment
- PORT 2 — not used by the 7400D

### **Mounting Options**

The 7400A data module can be configured as a stand-alone unit or in a multiple-mount housing.

The parts required for installing a single 7400D are:

- The 7400D data module
- An AC power converter
- A D8W telephone line cord
- An EIA RS-232-D cable

The 7400D data module can also be mounted in a new or existing 77A Data Mounting for multiple data module applications. The data mounting rack is provided with a built-in power supply and cables for distributing power for up to eight data modules.

21 Data Modules

*The 7400D Low-Speed Asynchronous Data Module*

21-18

## **Power Supply Unit**

---

An individual power supply unit is required with the 7400D data module *only when it is used as a stand-alone module*. When the 7400D is rack-mounted in a 77A rack-mount, the rack-mount provides powering capabilities for up to eight units. The power supply unit connects a grounded AC outlet and the "POWER" connector at the rear of the data module. This power supply unit provides the necessary operating voltages for the data module.

## **Tests**

---

The 7400D data module supports only the Self- test.

## **Data Module Features**

---

You can control the following operations via the 7400D's front panel:

- Option settings
- Self-Test and Reset Options features
- Adjustment of the contrast on the display
- Answer/disconnect and busyout

The following features are also available:

- Automatic or manual answering of incoming data calls
- Synchronous full-duplex operation
- Data rates of 300, 1200, 2400, 4800, 9600, and 19,200 bits per second

## 21 Data Modules

## The 7400D Low-Speed Asynchronous Data Module

21-19

## Setting Options

---

The following table presents the choices for each option of the Answer Only user interface and the order in which they are presented in the menu. All options must be set from the front panel. This table also shows the factory default for each option. (The **FACTORY DEFAULT** values are typed in larger type and in bold.)

**Table 21-1. Options Available to the Answer Only Interface and Their Default Settings**

Set Option Displays	Option Abbreviations	Possible Values
SET 300 SPEED?	300	ON, <b>OFF</b>
SET 1200 SPEED?	1200	ON, <b>OFF</b>
SET 2400 SPEED?	2400	ON, <b>OFF</b>
SET 4800 SPEED?	4800	ON, <b>OFF</b>
SET 9600 SPEED?	9600	<b>ON</b> , OFF
SET 19200 SPEED?	19200	ON, <b>OFF</b>
SET ANSWER?*	ANS	<b>AUTO</b> , MANUAL
SET CI LEAD?	CI	ON, <b>OFF</b>
SET CH LEAD?	CH	ON, <b>OFF</b>
SET CTS LEAD?	CTS	<b>NORMAL</b> , ON
SET DCD LEAD?	DCD	<b>NORMAL</b> , ON
SET DSR LEAD?	DSR	<b>NORMAL</b> , ON
SET DTR DETECT?	DTR	0,10,20,30, <b>50</b> ,100 MSEC
SET DTR LEAD?	DTR	EIA STANDARD, <b>IGNORE</b>
SET RI LEAD?	RI	CYCLE, <b>ON</b>
SET SIGLS DISC?*	SIGLS DISC	<b>ON</b> , OFF
SET TM LEAD?	TM	ON, <b>OFF</b>

---

\* On the MPDM, the SET ANSWER option is labeled AANS/OFF.  
the SET SIGLS DISC option on the MPDM is labeled SIGLS/OFF.

---

**21** Data Modules

*The 7400D Low-Speed Asynchronous Data Module*

21-20

## **FCC Registration**

---

No digital phones or data modules are FCC registered. The 7400D data module meets Part 15 Class A requirements and is labeled as such.

## **7400D Data Module PECs**

---

The 7400D Data Module can be ordered using the following PECs:

- **7400D Data Module**  
PEC: 2161-LSS  
Comcode: 107669954
- **Domestic Stand-alone Power Supply**  
PEC: 21625  
Comcode: 405509852
- **Power Supply for Western Europe**  
PEC: 2161-CEP  
Comcode: 407573559

## **Additional Documents**

---

The following document contains additional information relating to the 7400D Data Module:

- *7400D Data Module User's Guide, 555-020-712*

## The 8400B Plus Data Module

---

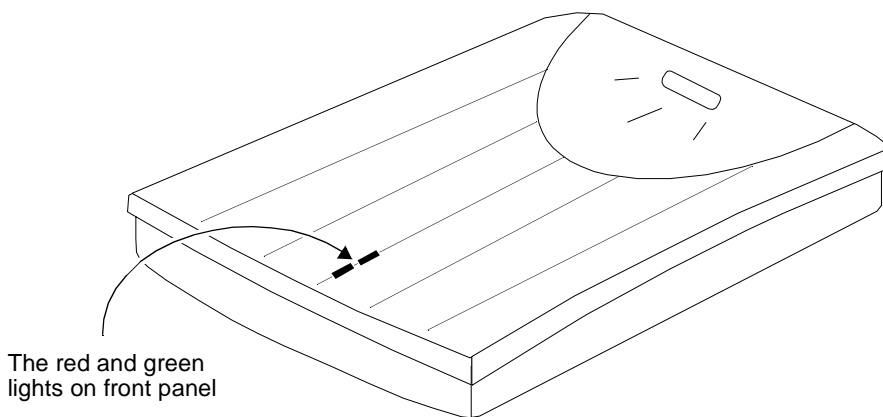

**Figure 21-5. The 8400B Plus Data Module**

Like the 7400B Plus data module, the 8400B Plus Data Module is a full-duplex asynchronous, data module that provides for simultaneous voice-data communications at the desktop over standard twisted pair wiring. However, it has been designed explicitly to work, in the linked mode, with 2-wire DEFINITY DCP circuits. That is, this data module is a data service link between a DTE device, a 2-wire voice terminal such as the 8400-Series voice terminals, and a DEFINITY G3V2 or later.

At the desk, the 8400B Plus data module provides asynchronous communication speeds ranging from 0.3 to 19.2 kbps. The 8400B Plus data module's ability to emulate a Hayes compatible modem interface makes it compatible with many standard PC communications packages that use Hayes Command sets. In addition, the 8400B Plus data module provides a voice dial capability that allows you to initiate voice calls from a PC using industry standard "auto-dialer" PC communications packages.

### Applications

The 8400B Plus data module can be used with the DEFINITY ECS G3V2 or later. The data module is used as a DCE for host access services, PC, or terminal (DTE) connectivity. The PC or other terminal device is connected to the 8400B Plus data module using a standard EIA-232-D cable and, if needed, the supplied

**21** Data Modules

*The 8400B Plus Data Module*

21-22

M9/F25 Adapter, an adapter which allows connection from a 9-pin jack to a 25-pin jack. A DCP interface (using a D8W-type modular telephone cord) is used to connect the 8400B Plus data module to the digital PBX.

The 8400B Plus data module may be optioned for use either with or without a telephone. In the stand-alone case, the 8400B Plus data module supports data service only. Otherwise, the 8400B Plus data module provides simultaneous data and voice service. The 8400B Plus works with all DCP voice terminals that support 2-wire operations (such as the 8400-Series voice terminals), to provide simultaneous data and voice service.

The voice dial feature allows you to dial a voice call without touching the telephone. Depending on your communications package, you may also store telephone numbers on a PC and recall them for dialing, log phone calls for easy billing, and take notes for later reference during a telephone conversation. In addition, the 8400B Plus data module can be used to automatically turn on the speakerphone of the voice terminal when a voice call is dialed from your terminal device.

Figure 21-6 shows a standard configuration in the United States, using a telephone and separate power supply. Figure 21-7 shows a standard international configuration using a telephone and separate power supply. Both the US configuration and the international configuration may be installed using a closet power supply as shown in Figure 21-8. This last installation eliminates the need for the separate power supply.



21 Data Modules

The 8400B Plus Data Module

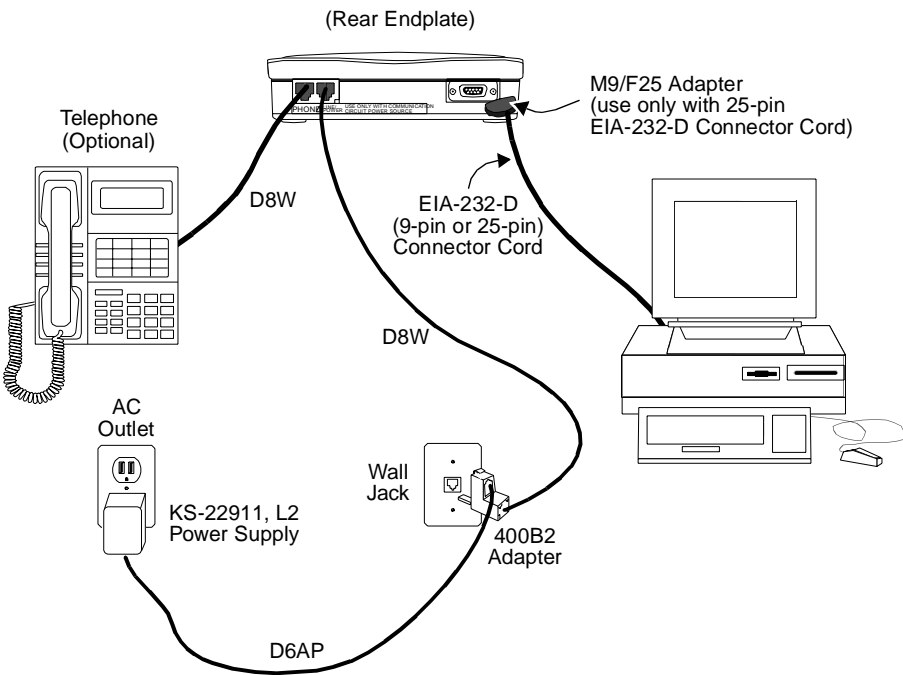

Figure 21-6. Typical Installation of the US Configuration, Including Telephone and Separate Power Supply

21 Data Modules

The 8400B Plus Data Module

21-24

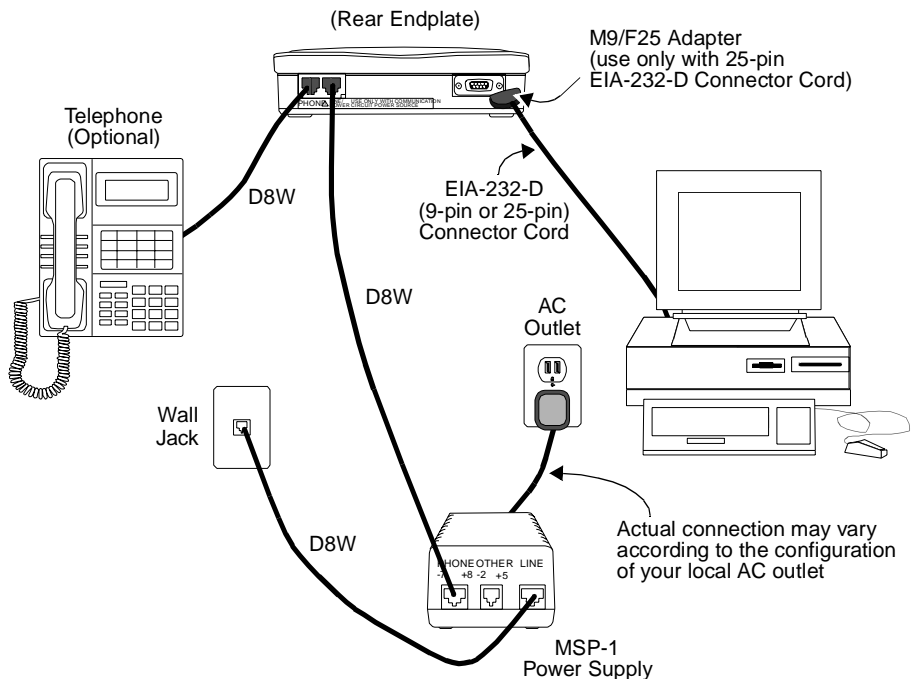

Figure 21-7. Typical Installation of the International Configuration, Including Telephone and Separate Power Supply

21 Data Modules

The 8400B Plus Data Module

21-25

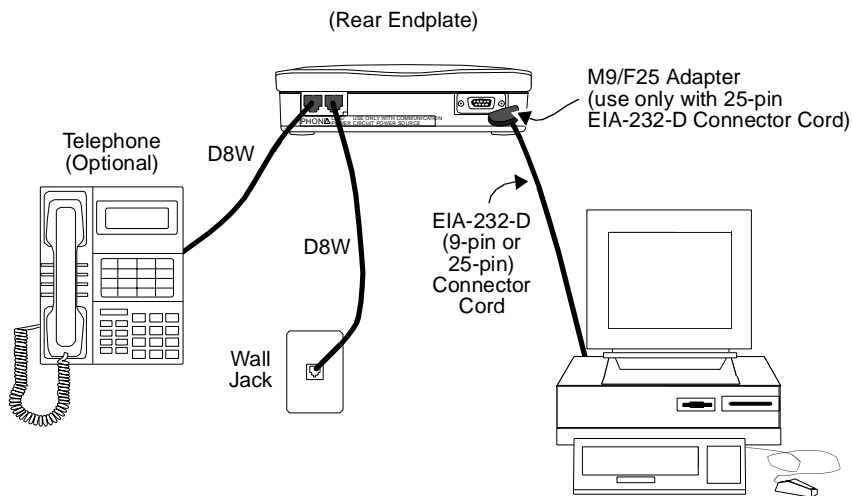

Figure 21-8. Typical Installation of the US and International Configuration, Including Telephone and Closet Power Supply

## Physical Description

### Dimensions



**NOTE:**

The following measurements for the 8400B Plus data module are approximate.

Width = 5 inches

Depth (front and rear) = 7-3/4 inches

Height = 1-1/4 inches

### Features

#### Lights

The front panel of the 8400B Plus has two lights, one red light and one green light. These lights indicate the status of the set during normal operation and the result of self-tests when initially powered.

## 21 Data Modules

### The 8400B Plus Data Module

21-26

When power is first applied to the 8400B Plus data module, the unit performs a self-test to verify that it is in working order. During the self-test, both lights will remain ON. When the self-test is complete, the green light turns OFF

- If self-test passed, the red light will remain ON. This indicates that your 8400B Plus data module is installed and ready for data communications operation.
- If self-test failed, the red light will FLASH (A Flash is a repeated pattern of 500 ms ON and 500 ms OFF.) three times, and then remain ON.

Other light indications are:

- **Idle in Normal Mode** — The green light is OFF; the red light is ON — This is the unit's normal mode if no active data call exists.
- **Incoming Call** — The green light FLASHES; the red light is ON — This indicates an incoming call.
- **Active Data Call** — Both the green and red lights are ON — This indicates an active data call.
- **Test Modes (Other Than Self-Test)** — Both green and red lights FLASH — This indication shows that the data module is in test mode.
- **Memory Error Mode** — The green light is OFF; the red light FLASHES — This indicates that the unit is defective. Call the Lucent Technologies Technical Service Center at 1 800 242-2121.
- **Switch Link Down** — The green light WINKS (A Wink is a repeating pattern of 750 ms ON and 250 ms OFF.); the red light emits an INVERTED WINK (An Inverted Wink is a repeating pattern of 250 ms ON and 750 ms OFF) — This indication shows that the unit is unable to communicate with the PBX. Restore the connection between the 8400B Plus and the PBX wall jack.
- **Phone Link Down** — The green light emits an INVERTED WINK; the red light WINKS — This indicates that the unit is unable to communicate with the telephone. Restore the connection between the 8400B Plus and the telephone.

## Other Physical Features

### Jacks

The 8400B Plus data module is equipped with the following jacks:

- **PHONE** — This connector accepts one end of the D8W telephone line cord used to connect a 2-wire voice terminal to the 8400B Plus data module.
- **LINE/POWER** — This connector accepts one end of the D8W telephone cord that connects the 8400B Plus data module and either:
  - a PBX wall jack already powered by a closet supply, or
  - a power supply, which is connected to the PBX wall jack.

**21** Data Modules

*The 8400B Plus Data Module*

21-27

- EIA CONNECTOR INTERFACE — This connector provides an interface between the 8400B Plus data module and the terminal (DTE) device.
  - If the communications port on the terminal device is a 9-pin interface, use a cord with DB9 male connectors on each end to connect the data module to the terminal device.
  - If the communications port on the terminal device is a 25-pin interface, use a 25-pin EIA-232-D cord, plus the supplied M9/F25 Adapter to connect the data module to the terminal device.

### Mounting Options

The 8400B Plus data module can be desk-mounted.

### Color Options

The 8400B Plus data module is available only in black.

### Tests

---

The 8400B Plus data module supports the following test and maintenance features:

- Local Loopback and Remote Loopback
- Local Loopback Self Test and Remote Loop Self Test
- DCP Looparound
- Self-Test
- Make Busy on Local Loop

### Capabilities

---

The 8400B Plus data module has the following basic features and capabilities:

- Nonvolatile, read-write memory for storing installation options, two data options profiles, and up to four telephone numbers
- Full-duplex, 10-bit start/stop, asynchronous operation
- Asynchronous data rates of 0.3, 1.2, 2.4, 4.8, 9.6, and 19.2 kbps
- Even, odd, mark, and space parity options
- Autobaud and autoparity
- Linked operation with the associated DCP voice terminal

## 21 Data Modules

### *The 8400B Plus Data Module*

21-28

- An AT command interface that emulates a Hayes 2400 Smartmodem and supports the following:
  - storage of the wait time for carrier detect interval (S-register S7)  
The number stored in the S7 register establishes the time the 8400B Plus data module will wait for call set up to be completed. This number can be set for any value up to a maximum of 255 seconds (with a default to 60 seconds).
  - voice call origination from your PC using the ATDP command (however, these calls must be terminated manually)
- Data metering which allows the data module and associated terminal to operate at higher speeds than the far-end data point
- Supports the semicolon modifier which enables an automatic return to the command mode after dialing a data call
- Speakerphone Activation before Dialing  
For terminal dialed voice calls, you can delay speakerphone activation until after a call is dialed. You would not hear touch tones or dial tone in this case.
- Power-up self-test
- Local and remote loopback tests with test duration timer
- Voice terminal powered by the PBX is not affected if AC power is removed from the 8400B Plus data module

Data features for host or terminal applications include:

- EIA/RS-232-D DCE interface
- Hayes SMARTMODEM 2400 user interface emulation

## **Power**

---

A Lucent Technologies power supply unit is shipped with each 8400B Plus data module. This unit connects to a grounded AC outlet, and provides a connection between the PBX wall jack and the 8400B Plus data module. The power supply unit provides the necessary operating voltages for the 8400B Plus data module.

## **Setting Options**

---

There are 28 S-registers in the 8400B Plus data module. Twenty-two S-registers are used to store configuration parameters; one is used to store installation options, and the remaining five are unused. Eleven registers can be stored in nonvolatile memory, which will be restored when the unit is powered up. There are two sets of stored registers, or profiles. When the 8400B Plus is first powered on, the values that were last stored in the S-registers are the values in effect until AT commands are issued to change them.

21 Data Modules

*The 8400B Plus Data Module*

21-29

You can check the current value stored in all S-registers with the `&V` command. To look at the contents of just one register, use the command `Smm?` where “mm” is the number of the S-register. The data module will return 3-digits, representing the decimal value of the specified S-register.

To change the value in any one S-register directly, use the command `Smm=nnn` where “mm” is the number of the S-register and “nnn” is the number you wish to place in the register.

For a full description of all 28 S-registers, see Appendix C in the *8400B Plus Data Module User's Guide*, 555-020-708.

## Notes for Use with PC Packages

Like the 7400B Plus, the 8400B Plus is able to use the following PC communication packages:

- CARBON COPY Plus V5.1
- Crosstalk XVI V3.71
- Crosstalk Mk.4 V1.1
- Hot Line V2.2 (voice dialing packages)
- HyperACCESS V3.32
- MicroPhone V1.5 (MacIntosh package)
- PC TOOLS Deluxe V6 (voice dialing packages)
- Procomm Plus V1.1B
- Relay Gold V3.0
- SideKick V1.5 and SideKick Plus (voice dialing packages)
- Smartcom II V2.2
- Smartcom II V3.1
- Smartcom III V1.1
- Smarterm 240 V3.0a
- Terra Nova V1.1.1
- White Knight V11 (MacIntosh package)

## 21 Data Modules

### *The 8400B Plus Data Module*

21-30

For those PC packages used to dial voice calls, the modem configuration must be set to PULSE (P) (even though the 8400B Plus will use Touch-Tone for voice calls). If given a choice, set modem type to HAYES.

#### NOTE:

While the 8400B Plus supports simultaneous voice and data, the packages listed here support *alternate voice/data dialing only*. Voice dialing packages interfere with data operation by remapping the COM port or by hanging up the data call.

#### NOTE:

You can dial a data call while on a voice call. In all cases, the linked telephone will work.

## FCC Registration

These data modules are not FCC registered. The 8400B Plus data module meets Part 15 Class A requirements and is labeled as such.

## 8400B Plus Data Module PECs

The 8400B Plus data module can be ordered in the United States using the following PECs:

- **8400B Plus Data Module**

PEC: 2172-2WB

Comcode: 407444835

(This package contains the data module, a D8W telephone cord, an M9/F25 Adapter, and an adjunct power kit containing a 400B2 Adapter, a D6AP-87 cord, and a KS-22911.L2 power supply.)

#### NOTE:

The 8400B Plus data module comes with a stand-alone power supply. However, it can also be closet powered.

## Additional Documents

The following documents contain additional information relating to the 8400B Plus data module:

- *8400B Plus Data Module User's Guide, 555-020-709*



## The 7500B Data Module

---

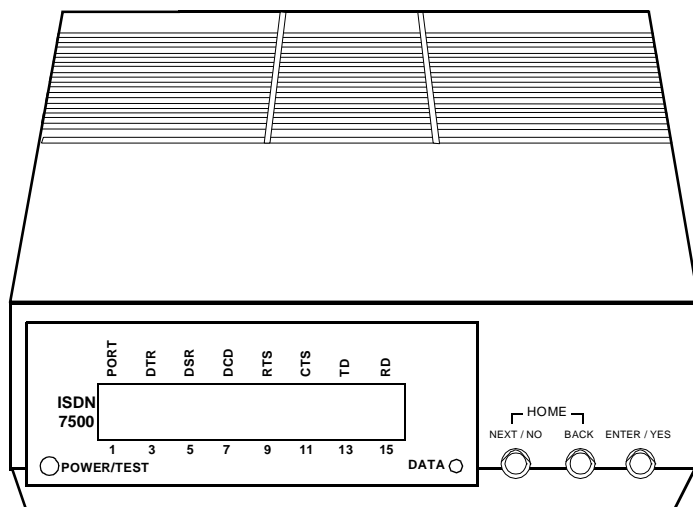

Figure 21-9. The 7500B Data Module

The 7500B Data Module is a terminal adapter primarily intended for connecting DTE or DCE to the ISDN network. It can be configured in a number of ways to allow the attached DTE and DCE to send and receive data through the digital network. The 7500B has no voice functions.

### Applications

---

The 7500B Data Module can be used with the DEFINITY Communications System Generic 2 through a 4-wire "T"-interface. It is used by the customer who wants to connect his DCE and DTE with DTE, DCE, or host processor at another location using an ISDN network. The 7500B data module cannot be used in a modem pooling or Host Access arrangement on a DEFINITY G2.

## Physical Description

---

### Dimensions



**NOTE:**

The following dimensions are approximate.

Width = 7 inches

Depth (front and rear) = 8-3/4 inches

Height = 1-3/4 inches

### Features

#### Lights

The 7500B data module has the following light indications:

- **POWER/TEST Light** — This red light goes on when the 7500B data module is on and flashes during all tests.
- **DATA Light** — This green light goes on when a data call is in progress. It flashes during self-test and when receiving an incoming data call that has not been answered.

#### Display

The 16-character LCD display shows the status information and option settings.

#### NEXT/NO, BACK, and ENTER/YES buttons

These buttons are used to step through each menu, set data communication options and functions, and adjust the contrast of the display.

### Other Physical Features

#### Jacks

The 7500B data module is equipped with the following jacks.

- **LINE** — used to connect the 7500B to the ISDN telephone network
- **PHONE** — (not used)
- **POWER** — used to connect the 7500B to its DC power supply. The power supply is connected in turn to a standard AC receptacle.

**21** Data Modules

*The 7500B Data Module*

21-33

- COMMUNICATIONS PORT 1 AND 2 — Port 1 is used to connect the 7500B to a data terminal, computer or modem. Depending upon which enhancement board is installed, port 2 can be used to connect automatic calling equipment (RS-366 interface) or a data terminal equipment with a V.35 interface.

### Mounting Options

The 7500B data module can be configured as a stand-alone unit or in a multiple-mount housing.

### Color Options

The 7500B data module is available in misty cream only.

## Capabilities

---

Using the available hardware and software options, the 7500B data module can be configured as an asynchronous DCE or a synchronous DCE. The capabilities of the different configurations are:

### Asynchronous DCE Features

The following data features can be used with the 7500B.

- EIA RS-232D interface
- Circuit switched data communications. Data options can be changed and data calls can be setup via commands from the EIA-432D interface.
- Ability to change options without dropping a data call
- Automatic or manual answering of incoming data calls
- Data rates of 0.3, 1.2, 2.4, 4.8, 9.6, and 19.2 kbps
- Asynchronous full-duplex operation
- RS-366 Automatic Calling Unit (ACU) interface (requires Multiple Enhancement Board)
- Hayes AT interface support

### Synchronous DCE Features

The synchronous DCE features with the Multipurpose Enhancement Board are as follows:

- EIA RS-232D interface
- Circuit switched or nailed-up data communication
- Data rates of 1.2, 2.4, 4.8, 9.6, 19.2, 56, and 64 kbps
- Full-duplex operation at all speeds

**21 Data Modules**

*The 7500B Data Module*

21-34

- Synchronous half-duplex emulation at 1.2 to 56 kbps
- Automatic answering of incoming data calls
- RS-366 ACU interface
- Autodial

The synchronous DCE features with the High Speed Synchronous Enhancement Board are as follows:

- V.35 interface
- Circuit switched or nailed-up data communication
- Data rates of 48, 56, and 64 kbps
- Full-duplex operation at all speeds
- Synchronous half-duplex emulation at 56 kbps only
- Automatic answering of incoming data calls
- Autodial

## **Distance Limitations**

---

The maximum signaling distance from the port board to the work location jack based on DIW 24 AWG cable is:

- Terminating resistor in work location — 1,900 feet
- Terminating resistor in satellite closet — 1,600 feet

## **Power Requirements**

---

The stand-alone 7500B Data Module operates with power from a modular AC to DC adapter that is normally plugged into a wall outlet. When the 7500B is used in a multiple mount arrangement, a built-in power supply is provided in the 77A Data Mounting.

## **Terminating Resistor**

A 440A4 Terminating Resistor adapter is required with the 7500B. The 440A4 can be located at the work location or in the satellite closet.

## **FCC Registration**

---

The 7500B data module is not FCC registered.

## **Additional Documents**

---

The following documents contain additional information relating to the 7500B Data Module:

*7500B Data Module User's Manual, 555-021-717*

## The ISDN Asynchronous Data Module (ADM)

---

The ISDN ADM is used in conjunction with an ISDN 7505, 7506, or 7507 voice terminal to provide integrated voice/data. With the ADM, an attached data terminal or personal computer can send and receive data through the switch. This unit mounts in the base of the voice terminal and is used instead of the Voice Only Module (VOM). The VOM cannot be upgraded to an Asynchronous Data Module.

### Physical Description

---

The following are physical characteristics of the ISDN ADM.

- The ISDN ADM is a printed circuit board built into the ISDN 7505, 7506, and 7507 Voice Terminal.
- Data and EIA RS-232-D connections — An EIA RS-232-D and an 8-pin modular jack are located on the back of the ADM.

### Features

---

The ISDN ADM offers the following features:

- Speed — Data rates of 0.3, 1.2, 2.4, 4.8, 9.6, and 19.2 kbps
- Full-duplex
- Asynchronous
- DATA/SEND/OFF button with two indicator lights; allows alternative data call setup from dial pad
- Data call setup from an ASCII keyboard through an EIA RS-232-D interface
- Ability to change options without dropping the data call
- Automatic or manual answering of incoming calls
- Remote and local loopback test
- Local mode operation for option setting and call control via terminal keyboard
- Hayes AT interface support

21 Data Modules

*The ISDN Asynchronous Data Module (ADM)*

21-36

## **Power Requirements**

---

Refer to the Power Requirements description in the ISDN 7505, 7506, and 7507 Voice Terminal section of this manual. (This information is located behind the tab labeled **ISDN Voice Terminals**.)

## **ISDN ADM PECs**

---

Refer to the PEC list in the ISDN 7505, 7506, and 7507 Voice Terminal section of this manual.

## **Additional Documents**

---

The following document contains information relating to the ISDN ADM:

- *ISDN Asynchronous Data Module Feature Package 2 User's Manual, 555-021-716*

## The Digital Terminal Data Module (DTDM)

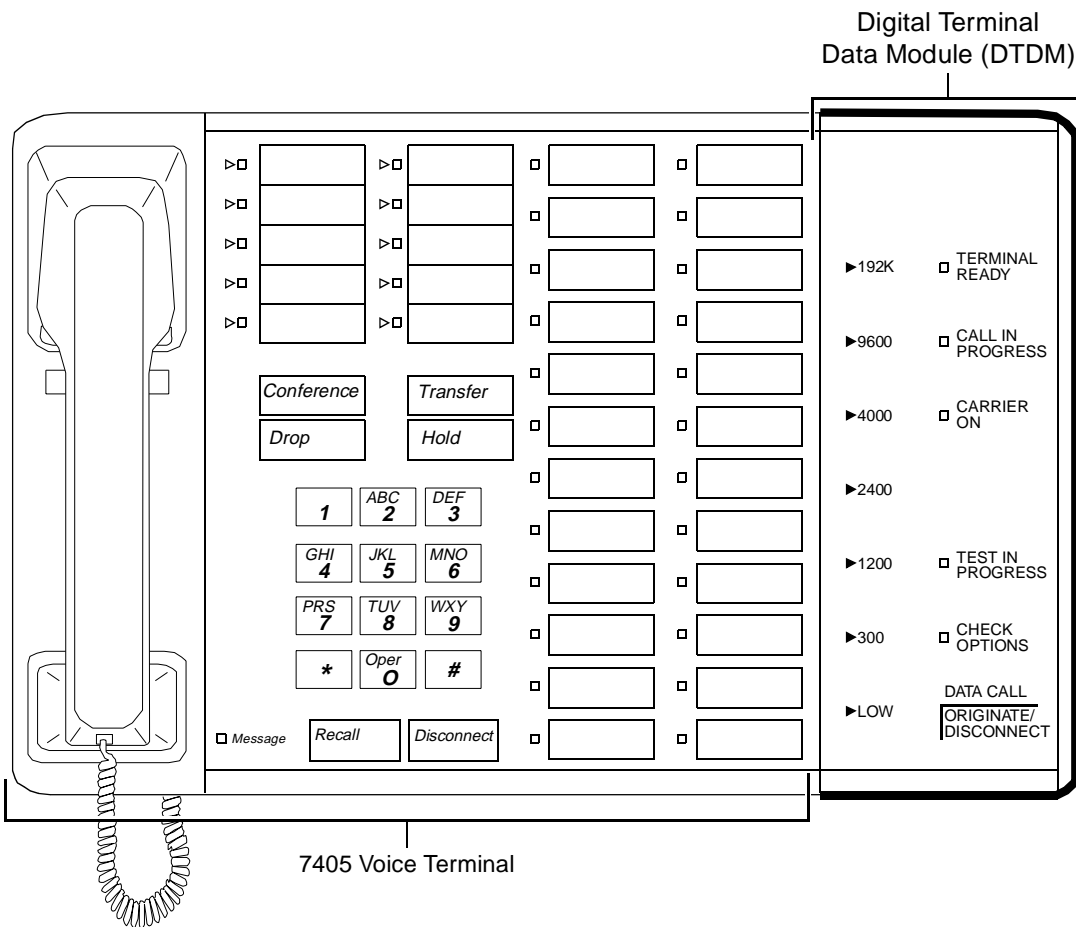

Figure 21-10. The Digital Terminal Data Module Mounted on a 7405D Voice Terminal

The DTDM provides a DCE interface to a DTE device that is connected to the DTDM (see Figure 21-11) and allows the DTE to communicate with the switch through the voice terminal and its mounting cord. Data calls and voice calls can be carried on simultaneously, or data calls can be initiated independently of voice calls. The DTDM and the digital voice terminal integrate data and voice into the DCP interface with the system digital switch. The voice terminal user can continue to access all voice features while the module is active on a data call.

21 Data Modules

The Digital Terminal Data Module (DTDM)

21-38

Addition of a DTDM allows an in-place 7403D or 7405D voice terminal to be upgraded for data communications at low cost.

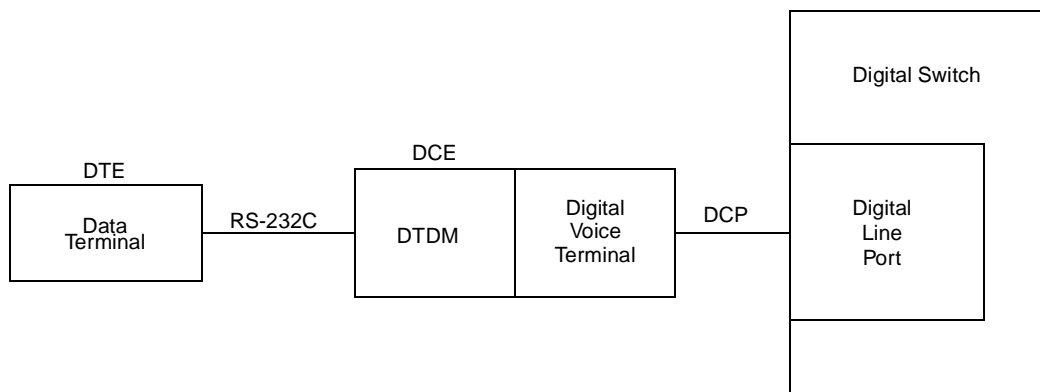

Figure 21-11. A Block Diagram of DTDM Interfaces

Physical Description

The DTDM is contained in a molded plastic housing styled to match the associated voice terminal. Status lights, switches, and controls are located on the faceplate and behind a hinged side cover.

Dimensions



NOTE:

The following dimensions are approximate.

Width = 4-3/4 inches

Depth (front to back) = 8-3/4 inches

Thickness = 1-1/2 inches



21 Data Modules

*The Digital Terminal Data Module (DTDM)*

21-39

## Features

### Lights

The DTDM is equipped with the following lights:

- Terminal Ready
- Call in Progress
- Carrier On
- Test in Progress
- Check options
- Receive Data
- Send data
- Test Result

### Speed Indicator lights

The DTDM is equipped with seven indicator lights that show the speed at which the DTDM is operating.

### Switches

The following switches can be used on the DTDM.

- Speed selector switch — The thumbwheel speed selector switch (located behind the side cover) selects data rates of LOW, 0.3, 1.2, 2.4, 4.8, 9.6, or 19.2 kbps.
- Test switch — The Self-Test and Local Loop/Remote loop switches are located behind the side cover.
- Option switches — The seven option switches are located behind the side cover.
- Data Call Switch — The DTDM is equipped with a Data Call Switch labeled Originate and Disconnect.

## Other Physical Features

### Mounting Options

The DTDM is physically mounted to a 7403D or 7405D voice terminal. It attaches to the right side of the voice terminal. The entire unit can be desk or wall mounted with one exception: if the voice terminal is equipped with a Function Key Module, Call Coverage Module or Digital Display Module and a DTDM, it cannot be wall mounted.

### Color Options

The DTDM is available only in silver.

21 Data Modules

*The Digital Terminal Data Module (DTDM)*

21-40

## Capabilities

---

The DTDM offers the following features and capabilities:

- Synchronous and asynchronous operation
- Half- and full-duplex operation
- Data transmission at standard rates up to 19.2 kbps
- Automatic answer option
- Self-test
- Remote and local loopback

## Power

---

The DTDM requires auxiliary power from one of the sources listed in the **Adjunct Power** section earlier in this manual.

## FCC Registration

---

The DTDM is not FCC registered.

## DTDM Equipment PECs

---

The DTDM can be ordered using the following PECs:

- Digital Terminal Data Module for 7403D—31745MTG05
- Digital Terminal Data Module for 7405D—31745MTG06
- Digital Terminal Data Module for 7405D and Function Key Module—31745MTG07
- Digital Terminal Data Module for 7405D and Call Coverage Module or Digital Display Module—31745MTG08
- Digital Terminal Data Module for 7405D and Function Key Module, and Call Coverage Module or Digital Display Module—31745MTG09

## Additional Documents

---

The following documents contain additional information relating to the DTDM:

- *System 75 and System 85 DTDM User's Guide*, 999-700-027
- *DEFINITY Generic 1 and Generic 2, System 75, and System 85 Terminals and Adjuncts Installation and Test*, 555-015-104

## The Z702AL1 Data Service Unit (DSU)

---

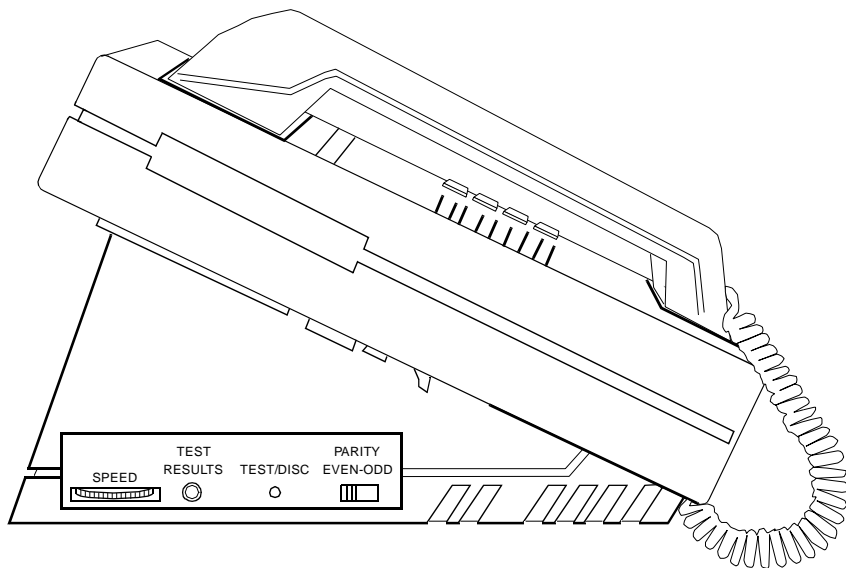

---

**Figure 21-12. The Optional Z702AL1 Data Service Unit Shown with a 7407D01B Voice Terminal**

The Z702AL1 DSU, when connected to the 7407D01B voice terminal, allows the user to transmit and receive voice and data over the same standard two pair of wires. The DSU provides the RS-232-C connection the data terminal needs to communicate with other data equipment without separate lines or modems. (See Figure 21-13.) The DSU supports asynchronous, full duplex operation.

**21** Data Modules*The Z702AL1 Data Service Unit (DSU)*

21-42

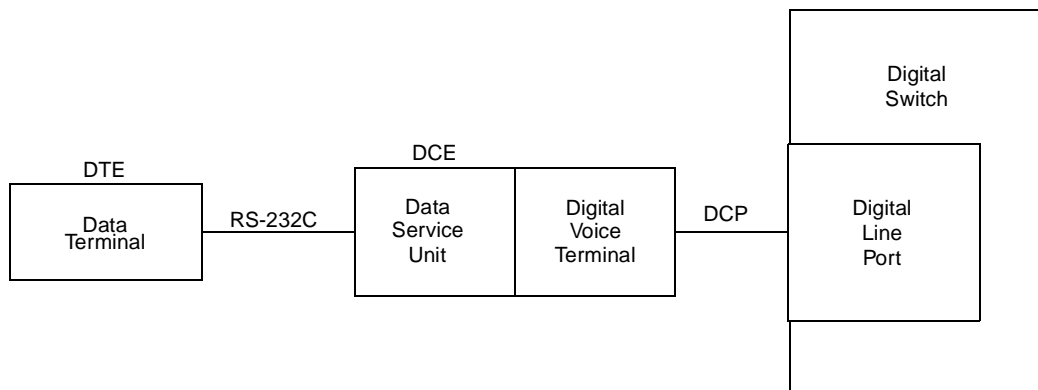
**Figure 21-13. A Block Diagram of Z702AL1 Data Service Unit Interfaces****Applications**

The Z702AL1 DSU can be used with a 7407D01B voice terminal connected to the DEFINITY Communications System Generic 1, Generic 2, and Generic 3, the DEFINITY ECS, System 75, and System 85. Typical applications are users with data terminals requiring a large number of features and lines.

**Physical Description****Features****Data Speed wheel**

The Data Speed wheel selects the speed of operation. It is located on the right side of the DSU.

**Self-Test light**

The Self-Test light is located on the right side of the DSU.

**Self-test or disconnect button**

The Self-Test or Disconnect button is located on the right side of the DSU.

**Parity switch**

The parity switch is located on the right side of the DSU.

**21** Data Modules

*The Z702AL1 Data Service Unit (DSU)*

21-43

## Other Physical Features

### Mounting Options

The optional Z702AL1 DSU Data Module Base is installed on the 7407D01B voice terminal.

### Color Options

The DSU is available in black only.

## Capabilities

---

The Z702AL1 DSU provides the following features:

- Selector for standard data rates of 0.3, 1.2, 2.4, 4.8, 9.6, and 19.2 kbps
- Asynchronous full duplex operation
- Automatic data call answering
- Data terminal keyboard dialing
- Data terminal keyboard disconnect
- Simultaneous voice operation
- Self-Test or Disconnect button
- Data Terminal Equipment (DTE) RS-232-C interface

## Power

---

The Z702AL1 DSU is powered by the 7407D01B which, in turn, is powered by a 110-volt AC wall receptacle.

**21** Data Modules

*The Z702AL1 Data Service Unit (DSU)*

21-44

---

**Z702AL1 DSU PECs**

---

The Z702AL1-DSU can be ordered using the following PEC:

- Z702AL1 DSU—31800A

---

**Additional Documents**

---

The following documents contain additional information relating to the DSU:

- *DEFINITY Generic 2 and System 85 7407D Voice Terminal User's Guide, 555-104-705*
- *System 85 Application Notes, 555-102-515*
- *System 75 Application Notes, 555-209-006*
- *DEFINITY Generic 1 7407D Voice Terminal User's Guide, 555-204-716*
- *System 75 7407D Voice Terminal User's Guide, 555-200-716*
- *DEFINITY Generic 1 and Generic 2, System 75, and System 85 Terminals and Adjuncts Installation and Test, 555-015-104*

## The 703A Data Service Unit (DSU)

---

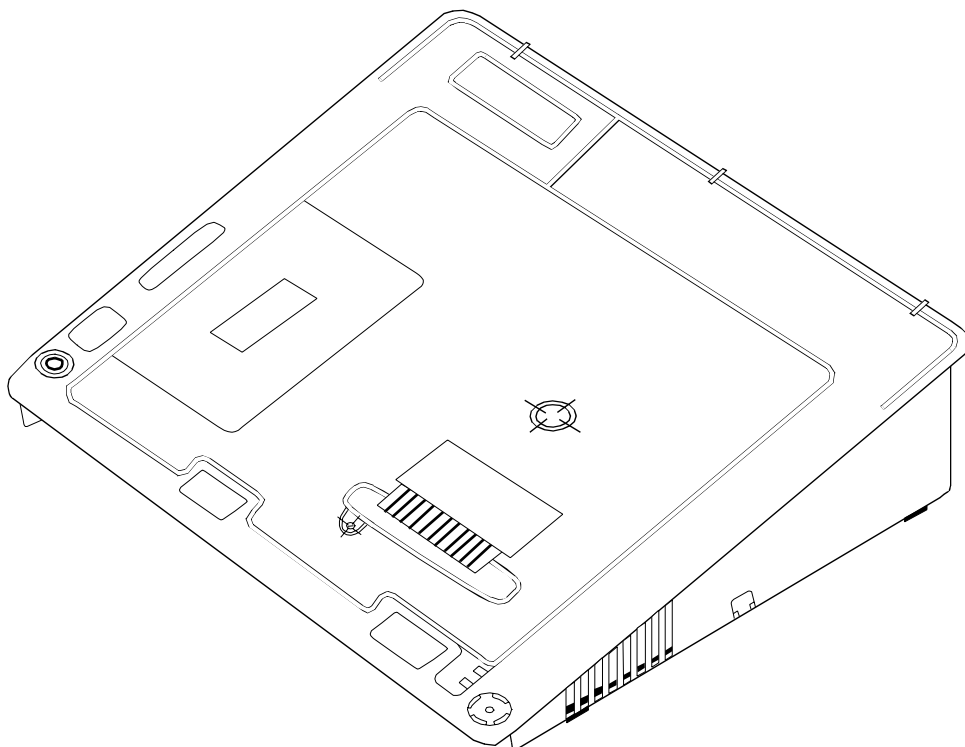

---

**Figure 21-14.** The 703A Data Service Unit

The 703A DSU is used with the 7406D voice terminal to provide asynchronous data communications through the switch. The DSU replaces the desk stand under the 7406D voice terminal and allows a data terminal (such as a 610 BCT) to be connected to the 7406D and data calls to be made to and from the switch. (See Figure 21-15.)

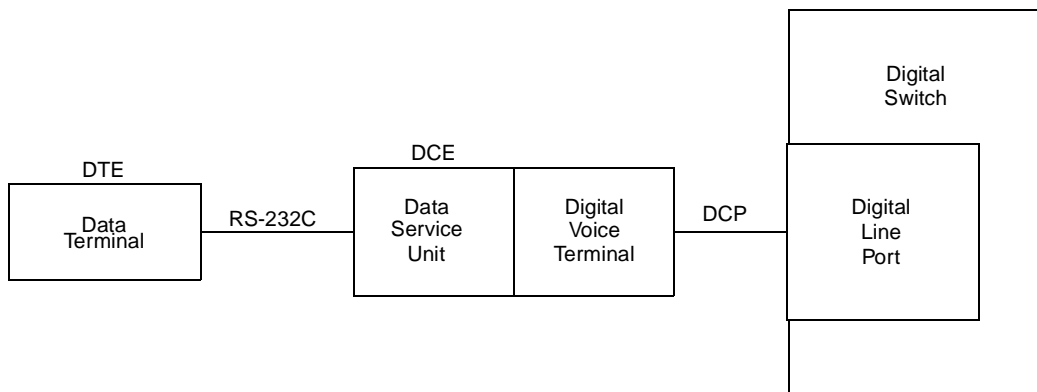

Figure 21-15. A Block Diagram of 703A Data Service Unit Interfaces

## Applications

The 703A DSU can be used with 7406D voice terminal connected to the DEFINITY Communications System Generic 1, Generic 2, Generic 3, the DEFINITY ECS, System 75, or System 85. Typical applications are users with data terminals requiring a large number of features.

## Physical Description

### Features

#### Option switches

The option switches for setting the operating speeds, disconnect sequence, and parity are located on the bottom of the DSU.

#### Self-Test button

The Self-Test button is located on the rear of the data stand adjacent to the RS-232-C connector. It is recessed and can be depressed with a pointed object such as a straightened paper clip.



**21 Data Modules**

*The 703A Data Service Unit (DSU)*

21-47

## **Other Physical Features**

### **Jacks**

The DSU contains four jacks. The handset cord jack is on the bottom of the DSU housing just under the left side of the housing. The mounting cord jack and the audio cord jack are on the bottom of the DSU housing just under the rear of the housing. The RS-232-C connector is on the rear of the DSU.

### **Mounting Options**

The optional 703A Data Service Unit Data Module Base is installed on the 7406D Voice Terminal. When the 7406D is equipped with the DSU, it cannot be wall mounted.

### **Color Options**

The DSU is available in black only.

## **Capabilities**

---

The 703A DSU provides the following features and capabilities:

- Selector for standard data rates of 0.3, 1.2, 2.4, 4.8, 9.6, and 19.2 kbps
- Asynchronous full-duplex operation
- Automatic answering of data calls
- Data terminal keyboard dialing
- Parity switch (even / odd)
- Disconnect sequence switch (escape, break)
- Quiet option switch
- Button for self-test and data call disconnect
- Simultaneous voice operation
- Speed matching to a lower speed of remote data endpoint
- Remote loop test (from a distant data module)
- EIA RS-232-C interface
- Appearance of dialed number on the DTE screen (7406D02A only) during data call setup with the ASCII DTE
- Display features for the 7406D02A on the attached CRT

21 Data Modules

*The 703A Data Service Unit (DSU)*

21-48

## Power

---

The 703A DSU requires an external power source. Refer to the **Adjunct Power** section earlier in this manual for the correct power source.

## 703 DSU PECs

---

The 703A DSU can be ordered using the following PEC:

- 703A Data Stand — 31824A

## Additional Documents

---

The following documents contain additional information relating to the 703A DSU:

- *DEFINITY Generic 2 and System 85 7406D Voice Terminal User's Guide*, 555-104-702
- *DEFINITY Generic 1 7406D Voice Terminal User's Guide*, 555-204-719
- *System 75 7406D Voice Terminal User's Guide*, 555-200-719
- *DEFINITY Generic 1 and Generic 2, System 75, and System 85 Terminals and Adjuncts Installation and Test*, 555-015-104

## The DEFINITY High Speed Link

---

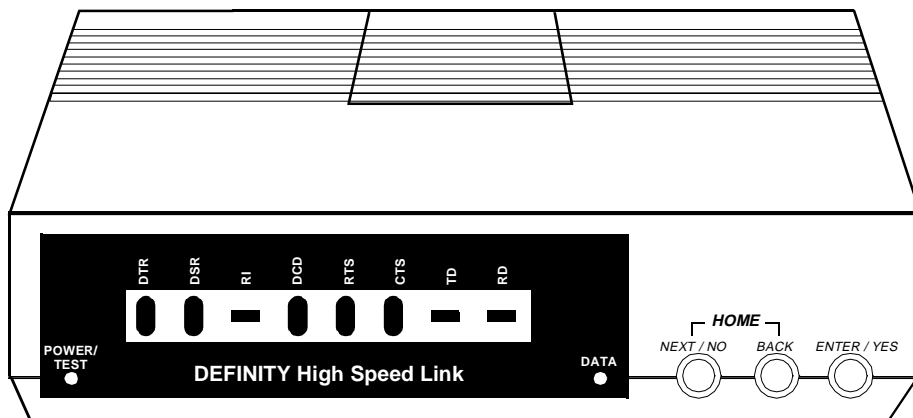

Figure 21-16. The DEFINITY High Speed Link

The DEFINITY HSL is a data service unit that allows data equipment to access the data services of System 75 and System 85 and the DEFINITY switch. It is used where the integration of voice and data is not required. The HSL supports synchronous data transmission at speeds of 56 and 64 kbps, and provides a link to high speed data networks.

The DEFINITY HSL provides access to various switched and dedicated (private) data networks, including Group 4 Fax, Video Teleconferencing, LAN Interconnect, and Cluster Controller/Front-End Processor Connections.

## Physical Description

---

### Dimensions



**NOTE:**

The following dimensions are approximate.

Width = 7 inches

Depth (front and rear) = 9-1/4 inches

Height = 1-3/4 inches

Weight = 1 pound 5 ounces

### Features

#### Lights

The DEFINITY HSL is equipped with the following lights:

- **POWER/TEST light** — This red light goes on steadily when there is power to the HSL; winks during all tests; and flashes with the **DATA** light for line fault indication.
- **DATA light** — This green light goes on steadily indicating a data call is in progress; flashes when receiving an incoming call; and flashes with the **POWER/TEST** light for line fault indication.

#### Display

This 16-character LCD display shows the start-up sequence, status, option information, and test information.

#### **NEXT/NO, BACK, and ENTER/YES buttons**

These buttons are used to step forward and backward through the menus. These buttons are also used for executing functions.

## Tests

The DEFINITY HSL supports the following tests and maintenance features:

- Self-test
- Local loopback
- Data loopback
- Remote loopback (V.54 and AT&T proprietary protocol)
- Remote loopback with self-test
- DCP looparound test
- DDS latching/non-latching loopback

## Connectors

The following connectors are located on the rear panel of the HSL:

- RS-366/RS-232 (user must provide interface cable)
- V.35 (user must provide interface cable)
- LINE (cord shipped with set)
- POWER (for single installations, power is provided by a separately ordered stand-alone power supply – PEC 21625; for rack mounted installations, power is included with the Z77A Data Mounting – PEC 21626)

## Other Physical Features

### Mounting Options

The HSL can be used as a stand-alone unit. It can also be installed in a Z77A multiple-mount rack.

### Color Options

The DEFINITY HSL is available in misty cream only.

## Capabilities

---

The basic features and capabilities of the DEFINITY HSL are:

- DCP operation up to 5,000 feet from the switch
- Supertwist LCD and three push-buttons for displaying status, setting options, controlling tests, storing telephone numbers, originating and manually answering calls
- Two LEDs for power, incoming calls, data mode, test mode and fault indications
- V.35 internally timed, synchronous interface for 56 kbps half duplex operation, 56 kbps full duplex operation, and 64 kbps full duplex operation

**21 Data Modules**

*The DEFINITY High Speed Link*

21-52

- RS-366 ACU interface for originating data calls
- RS-232 AT command interface with autobaud for originating and disconnecting calls
- Test features for system fault isolation
- Non-volatile memory for storing an option profile and four telephone numbers
- Reset options for easy loading of default options
- Data inversion option for compatibility with older 64 kbps DCP data modules
- Automatic or manual answer option
- DTR lead ignore option for operation with terminals that normally interface with private line DCE equipment
- DSR lead ON option for operation with terminals that normally interface with private line DCE equipment
- Optional DTR lead activated dial feature for stored number dialing
- Permanent connection option for operation in private line applications
- Memory cartridge interface for firmware upgrades

## Applications

### Administration

The DEFINITY HSL is administered and/or aliased as an MPDM. Routing, trunking and other administration considerations mirror those of the MPDM. The uses of the DEFINITY HSL are compatible with those of an MPDM.

### Switched Requirements

The following sections describe switched requirements.

#### Releases for Switched Applications

The switch releases which support the applications of the DEFINITY HSL are:

- System 75 R1V2 or later
- System 85 R2V3 or later
- DEFINITY Generic 1, Generic 2, and Generic 3
- DEFINITY ECS

All versions of the switch do not provide the same level of support. The biggest difference is in the type of network access arrangement that is supported.

### Switched Endpoints

The DTE must be capable of communicating at 56 kbps or 64 kbps. Proper switched operation requires that the DTE supports a Data Terminal Ready (DTR) lead on its V.35 interface. The DTR lead provides the signal to the HSL that it is ready to receive or originate a call. Before the High Speed Link can originate (dial) or answer a call, the DTR lead must be asserted (high) by the DTE. In addition, the DTE uses the DTR lead to signal the HSL to drop a call. This is accomplished by turning off its DTR lead.

### Switched Applications

Switched applications are applications using the switched network. ACCUNET Switched Digital Services (SDS) and Software Defined Data Network (SDDN) are examples of switched applications. See Figure 21-17 for an example of a switched configuration. For additional information on switched applications, implementations, and administration, refer to the *DEFINITY High Speed Link User's Manual*, 555-020-711, Appendix D: Applications and Switch Administration.

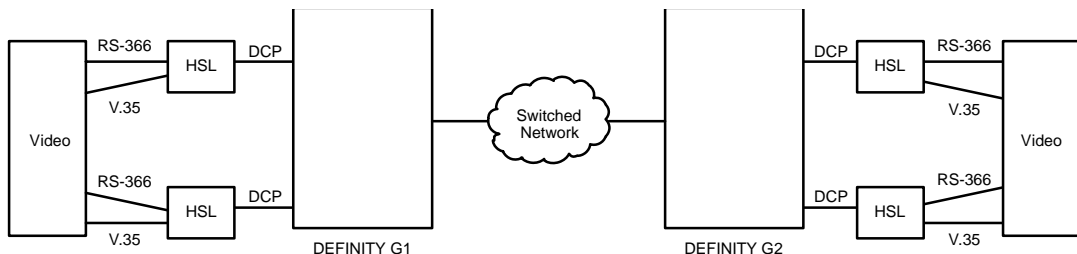

Figure 21-17. Switched Network Application

## Permanent (Private Line) Requirements

The following sections describe Permanent (Private Line) requirements.

### Releases for Permanent Applications

Permanent applications require the switch to establish and maintain the connection. The switch release and corresponding feature that support permanent connections are:

- System 75 R1V2 or later - Permanent Switched Call (PSC)
- System 85 R2V4 or later - Dedicated Switch Connection (DSC)
- DEFINITY Generic 1 - Administered Connection (AC) or Permanent Switched Call (PSC)
- DEFINITY Generic 2 - DSC
- DEFINITY Generic 3 and the DEFINITY ECS - AC

These various switch features provide different levels of support for permanent applications. The DEFINITY G3 and DEFINITY ECS provide the broadest level of support with the Administered Connection Feature. The Permanent Switch Call in System 75 and DEFINITY G1 and the Dedicated Switch Connection in System 85 and DEFINITY G2 provide a subset of that functionality.

### Permanent Endpoints

If DTE does not support the DTR lead, then the DTR IGNORE option must be used. This will allow a permanent connection to be established and maintained.

### Permanent Applications

A permanent connection uses a DS0 channel on a private T1 between sites, or a DS0 channel on a DS1 to a private digital network such as ACCUNET Spectrum of Digital Services (ASDS). See Figure 21-18 for an example of a Front End Processor/Cluster Controller application in a permanent connection configuration. For additional information on permanent applications, implementations, and administration, refer to the *DEFINITY High Speed Link User's Manual*, 555-020-711, Appendix D: Applications and Switch Administration.



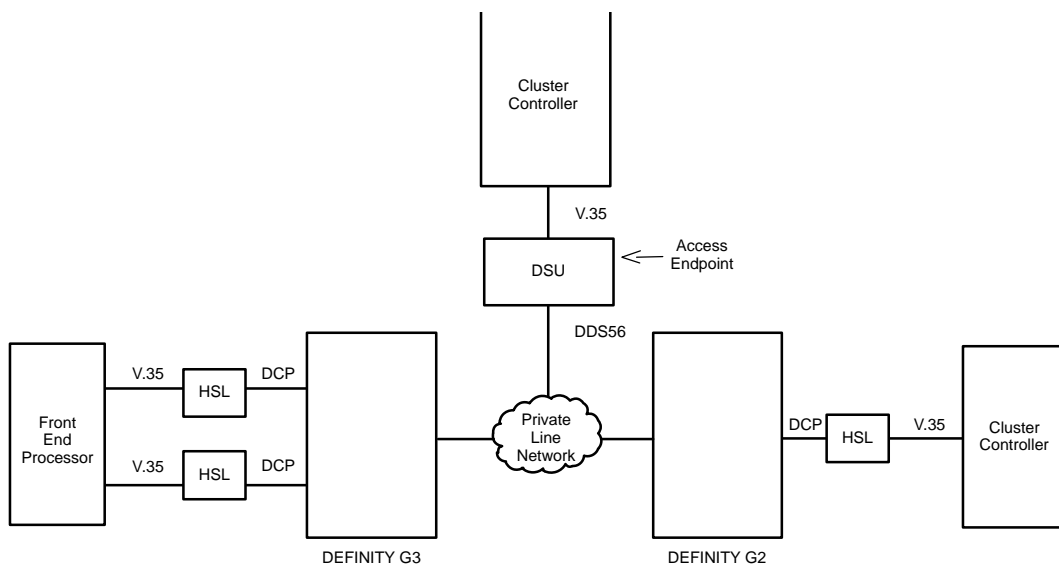

Figure 21-18. Permanent (Private Line) Applications

## Power

The DEFINITY HSL is powered by an external power supply. The connection to the power supply uses a six position male connector with one pin removed for polarization.

### Power requirements:

- AC Voltage – 104 to 129 volts
- Frequency – 57 to 63 Hz
- Power Consumption – 9 watts

21 Data Modules

*The DEFINITY High Speed Link*

21-56

## Considerations

---

The DEFINITY HSL will not support the following:

- Asynchronous data transmission
- Integrated voice and data

## FCC Registration

---

Digital phones and data modules are not FCC registered. The DEFINITY HSL meets FCC Part 15 approval, and is labeled as such.

## DEFINITY HSL PECs

---

The DEFINITY HSL can be ordered using the following PECs:

- **DEFINITY High Speed Link**  
PEC 2161-201  
Comcode: 106654478
- **Stand-alone Power Supply** – PEC 21625
- **Z77A Data Mounting (rack with power for up to 8 HSL units)**  
PEC 21626, Attribute 1— Z77A with WP90780L2 digital line  
installation harness  
PEC 21626, Attribute 6 – Z77A only

## Additional Documents

---

The following document contains additional information relating to the DEFINITY HSL:

- *DEFINITY High Speed Link User's Manual, 555-020-711*

## The Processor Data Module (PDM)

---

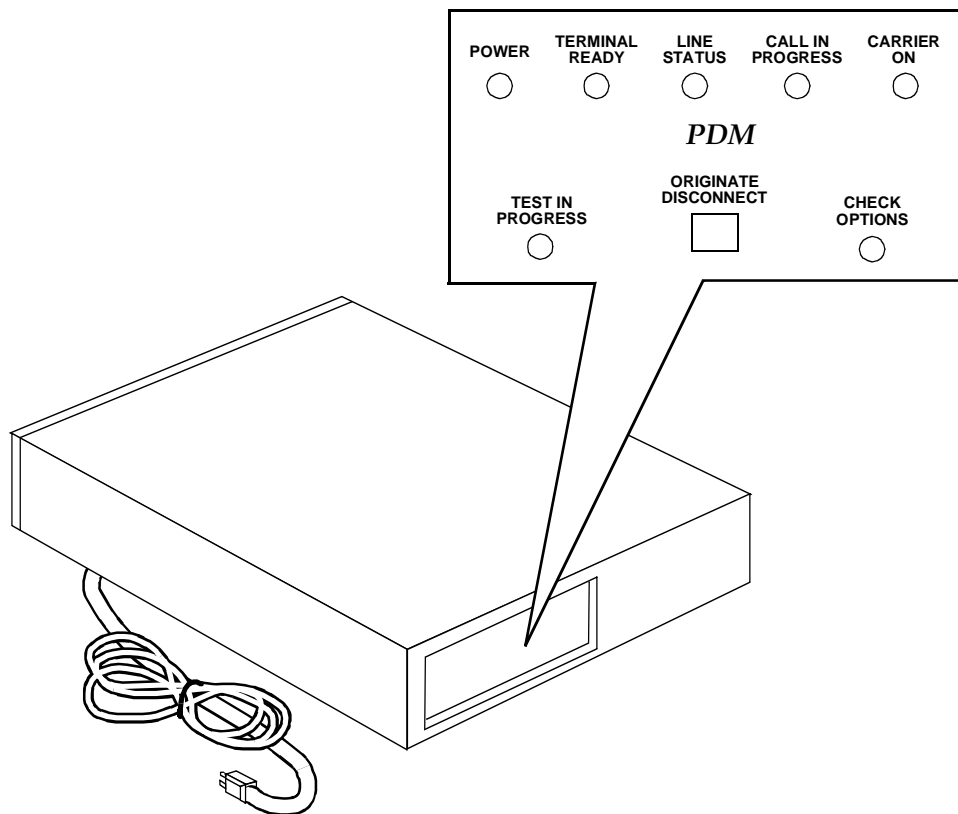

Figure 21-19. The Processor Data Module, the Stand-alone Model

The PDM provides a DCE interface for connection to data terminals, Station Message Detail Recording (SMDR) output device, on-premises administration terminal, Applications Processor (AP), Call Management System (CMS), Property Management System (PMS), Audio Information Exchange (AUDIX), and host computers. It also provides a DCP interface for connection to the digital switch.

**⇒ NOTE:**

The PDM can no longer be ordered. It has been replaced by the MPDM.

## Physical Description

---

### Features

#### Switches

The PDM is equipped with the following switches:

- Originate/Disconnect — This switch is located on the front panel. It is used when originating and disconnecting from a call.
- Self-Test — This switch is located behind the front faceplate. Pressing this button performs the self-test.
- LOC LOOP/REM LOOP — This switch is located behind the faceplate. It is used to perform the Local loop test or Remote loop test.
- Options — The option switches are located behind the front faceplate. There are 30 option switches, 25 for options, and 5 spares.

#### Lights

The PDM is equipped with the following lights:

- Power
- Terminal Ready
- Line Status
- Call in Progress
- Carrier on
- Test in Progress
- Check option
- Test Result
- Send Data
- Receive Data

### Other Physical Features

#### Mounting Options

The PDM can be configured either in a stand-alone or multiple mounted version. The stand-alone version is installed in a 70A Data Mounting aluminum housing that is equipped with plastic front and rear covers. A maximum of eight PDM's can be installed in the 71A Data Mounting.

The stand-alone version can be mounted on a surface or desk top near the associated data terminal. The multiple mount is normally contained in an auxiliary cabinet.

**21 Data Modules**

*The Processor Data Module (PDM)*

21-59

## **Capabilities**

---

The PDM offers the following features:

- Synchronous or asynchronous operation
- Full- or half-duplex operation for data calls up to 56 kbps
- Full-duplex operation for data calls at 64 kbps
- Data transmission at standard rates up to 19.2 kbps
- Automatic answer option
- Self-test

## **Power**

---

Both mounting arrangements require power from a 115-volt AC receptacle to power the PDM(s).

## **PDM Equipment PECs**

---

The PDM cannot be ordered; therefore, no PEC is available.

## **Additional Documents**

---

The following documents contain additional information relating to the PDM:

- *Processor Data Module User's Guide*, 999-700-028
- *DEFINITY Generic 1 and Generic 2, System 75, and System 85 Terminals and Adjuncts Installation and Test*, 555-015-104

## The Trunk Data Module (TDM)

---

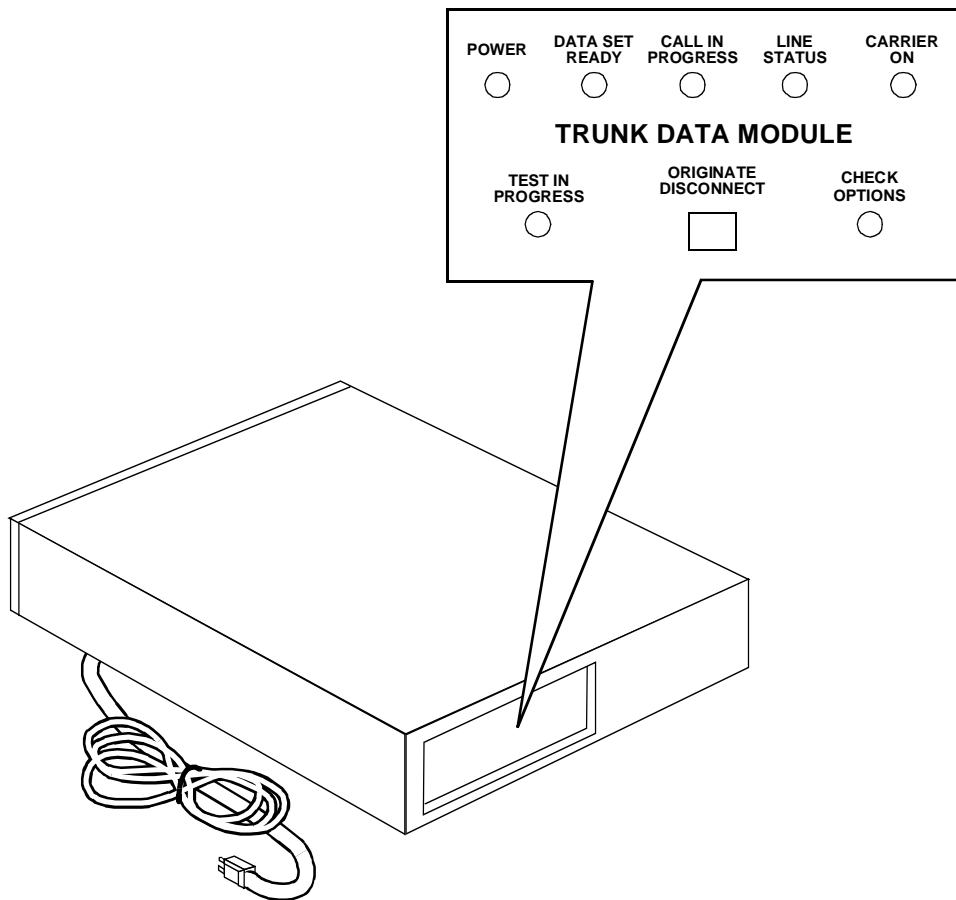

Figure 21-20. The Trunk Data Module, the Stand-alone Model

The TDM provides an RS-232-C DTE interface for connection to off-premises private line trunk facilities or a switched network telecommunications network and a DCP interface for connection to the digital switch.

21 Data Modules

*The Trunk Data Module (TDM)*

21-61

The TDM can serve as part of a conversion resource for modem pooling. The conversion resource performs the analog-to-digital and digital-to-analog conversions that allow the analog and DCP data endpoints to communicate. A single conversion resource consists of a modem and a TDM connected at the RS-232-C interface.



**NOTE:**

The TDM can no longer be ordered. It has been replaced by the MTDM.

## Physical Description

---

### Features

#### Switches

The TDM is equipped with the following switches:

- Originate/Disconnect — This switch is located on the front panel. It is used when originating and disconnecting from a call for test purposes.
- Self-Test — This switch is located behind the front faceplate. Pressing this button performs the self-test.
- LOC LOOP/REM LOOP — This switch is located behind the faceplate. It is used to perform the Local loop test or Remote loop test.
- Options — The option switches are located behind the front faceplate. There are 30 option switches, 24 for options, and 6 spares.

#### Lights

The TDM is equipped with the following lights:

- Power
- Data Set Ready
- Line Status
- Call in Progress
- Carrier on
- Test in Progress
- Check option
- Test Result
- Send Data
- Receive Data

21 Data Modules

*The Trunk Data Module (TDM)*

21-62

## Other Physical Features

### Capabilities

---

The TDM offers the following features and capabilities:

- Synchronous or asynchronous operation
- Full- or half-duplex
- Selected standard data rates up to 19.2 kbps
- Automatic answer
- Self-test

### Mounting Options

The TDM can be configured either in a stand-alone or in a multiple mounted version. The stand-alone version is installed in a 70A Data Mounting aluminum housing that is equipped with plastic front and rear covers. A maximum of eight TDMs may be installed in the 71A Data Mounting.

The stand-alone version can be mounted on a surface or desk top near the associated data equipment. The multiple-mounting carrier unit is normally installed in an auxiliary cabinet.

### Power

---

Both mounting arrangements require power from a 115-volt AC receptacle to power the TDM.

### TDM Equipment PECs

---

The TDM is no longer orderable; therefore, no PEC is available.

### Additional Documents

---

The following documents contain additional information relating to the PDM:

- *Trunk Data Module User's Guide*, 999-700-029
- *DEFINITY Generic 1 and Generic 2, System 75, and System 85 Terminals and Adjuncts Installation and Test*, 555-015-104



## The Modular Processor Data Module (MPDM)

---

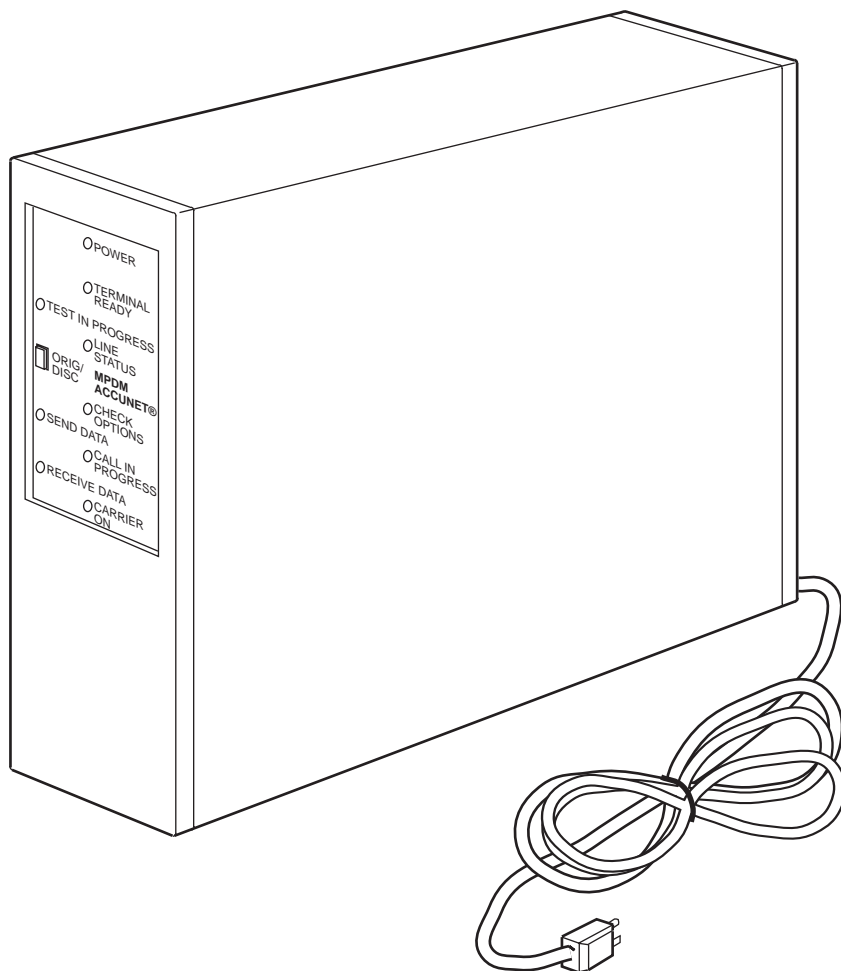

---

Figure 21-21. The Stand-Alone Modular Processor Data Module

The MPDM is a multi-purpose data module configured to provide the digital switch interface to support various data interface requirements. The MPDM is similar in appearance and function to the PDM.

21 Data Modules

*The Modular Processor Data Module (MPDM)*

21-64

The MPDM can be configured to support the Data Call Setup or Off-Premises Data-Only Extensions features. In addition to standard data transmission rates supported by previous versions of the PDM's (0.3, 1.2, 2.4, 4.8, 9.6, and 19.2 kbps), the MPDM supports data rates of 56 and 64 kbps.

The individual piece parts for the MPDM can be purchased either separately or in one of the three different preassembled packages described below.

- AUDIX/CMS MPDM

This MPDM package provides connectivity from either Lucent Technologies AUDIX or CMS to the DCIU link of the DEFINITY Communications System Generic 1, Generic 2, and Generic 3, the DEFINITY ECS, System 75, and System 85. The AUDIX/CMS MPDM supports any endpoint that requires low speed (below 19.2 kbps) synchronous connectivity.

- The Video Teleconferencing MPDM

This MPDM package allows high speed data endpoints to be switched through the DEFINITY G1, G2, and G3, the DEFINITY ECS, System 75, and System 85, to high speed public or private networks. The Video Teleconferencing MPDM supports an RS-366 Automatic Calling Unit (ACU) interface to permit dialing through the endpoint (for example, a Video Teleconference unit or Group 4 FAX machine).

In addition to the RS-366 interface, the Video Teleconferencing MPDM also uses the ACCUNET D-Kit which allows transmissions over 56 kbps and 64 kbps facilities such as ACCUNET Switched Digital Service. (ACCUNET Switched 56 kbps Digital Service is an end-to-end switched digital service accessed by the switch through a DS-1 interface.)

- The High Speed Synchronous MPDM

This MPDM package is designed to support high-speed data applications that do not require the use of an RS-366 ACU interface (for example, nailed-up or dedicated calls such as Cluster Controller to Front End Processor). With the addition of an optional interface card, the High Speed Synchronous MPDM supports connections over switched or private networks through System 75, System 85, and a DEFINITY G1 and G2.

 **NOTE:**

All three MPDM preassembled packages use the same housing and main circuit card. The distinguishing components are, therefore, the interface cards that each uses.

21 Data Modules

*The Modular Processor Data Module (MPDM)*

21-65

## General Features of the MPDM

---

Both the MPDM stand-alone and multiple mount versions are contained in a 70A Data Mounting aluminum housing that is equipped with plastic front and rear covers.

The MPDM, in general, offers the following data features:

- Selected data rates up to 64 kbps
- Synchronous or asynchronous operation
- Synchronous operation at 56 kbps and 64 kbps
- Full- or half-duplex operation up to 56 kbps
- Full-duplex operation at 64 kbps
- Automatic answer option
- ACCUNET digital service interface support
- Local Area Network (LAN) bridging: Token Rings, Ethernet, AppleLan

## Functional elements

- The Main module comes in one version that is common to all of the MPDM packages and provides the basic digital interface and protocol conversion functions.
- The Interface module comes in three versions providing a choice of V.35, RS-232-C, or RS-449 interfaces (balanced--RS-422A electrical interface).
- The ACU module comes in one optional version. The ACU module interface provides the capability to emulate an ACU and supports the RS-366 interface. This module is required for the data terminal dialing function of the Data Call Setup feature.

## Mounting

The MPDM can be configured either in a stand-alone or in a multiple mount version. A maximum of eight MPDMs can be installed in the 71A Data Mounting.

The stand-alone version can be mounted on a surface or desk top near the associated data equipment. The multiple-mounting carrier unit is normally installed in an auxiliary cabinet.

## Power

Both mounting arrangements require power from a 115-volt AC receptacle to power the MPDM(s).

21 Data Modules

*The Modular Processor Data Module (MPDM)*

21-66

## Switches

The MPDM is equipped with the following switches:

- **ORIGINATE/DISCONNECT** — This switch is located on the front panel. It is used when originating and disconnecting a call from a terminal that does not have a BREAK key.
- **SELF-TEST** — This switch is located behind the front faceplate. It is used to perform the self-test.
- **LOC LOOP/REM LOOP** — This switch is located behind the faceplate. It is used to perform the Local loop test or Remote loop test.

 **NOTE:**

If you are using the Video Teleconferencing MPDM or the High Speed Synchronous MPDM preassembled package, and the OFF/ANET switch is set to ANET), the user-activated Remote Loop will not function since Remote Loop requires Mode 2 handshake operation.

- **Options** — The option switches are located behind the front faceplate. There are two Dual In-line Package (DIP) option switches, one with 10 positions, the other with 12 positions. Twenty-one of the positions are used to set the options. The other is a spare reserved for future use.

The RS-232-C interface card has eight DIP switches to set its options.

## Lights

The MPDM is equipped with the following lights:

- Power
- Terminal Ready
- Line Status
- Call in Progress
- Carrier on
- Test in Progress
- Check option
- Test Result
- Send Data
- Receive Data

## Features of the AUDIX/CMS MPDM Package

### Functional Elements

This preassembled package consists of the following parts:

- Stand-alone housing
- Modular PDM
- RS-232 interface card
- Option Switch Settings

Since the AUDIX/CMS MPDM is preassembled, you will need only to make the connections to the PBX, and set the DIP switches. Use the following table to verify that the DIP switch settings connected to AUDIX or CMS are correctly set.

**Table 21-2. DIP Switch Settings on the AUDIX/CMS MPDM**

DIP Switch	Setting
OFF/LOW	OFF
OFF/300	OFF
OFF/1200	OFF
OFF/2400	OFF
OFF/4800	OFF
OFF/9600	9600
OFF/19.2	OFF
OFF/56K	OFF
OFF/64K	OFF
OFF/TRBK	OFF
FDX/HDX	FDX
ASYN/SYNC	SYNC
EXT/INT	INT
OFF/DISC	OFF
OFF/KYBD	OFF
OFF/PRTY	OFF
O/EV-I/OD	ignored
OFF/DMLL	OFF
OFF/MKBY	OFF
Spare	OFF
OFF/SIGLS	SIGLS
OFF/AANS	AANS

## Features of the Video Teleconferencing MPDM

### Functional Elements

The preassembled Video Teleconferencing MPDM consists of the following parts:

- Stand-alone housing
- Modular PDM
- V.35 interface card
- RS-366 ACU interface card
- V.35 M1 (ACCUNET D-Kit)



**NOTE:**

The label on the front of this MPDM renames the data module from "MPDM" to "MPDM ACCUNET."

### Option Settings

The Video Teleconferencing MPDM offers a new option switch, OFF/ANET.

- If this switch is set to OFF, the MPDM/ACCUNET functions as a standard MPDM.
- If this switch is set to ANET, the Video Teleconferencing MPDM can be optioned for compatibility with ACCUNET Switched 56 kbps Digital Service or non-MPDM endpoints such as a DSU. In this mode:
  - No Mode 2 handshaking is required to go into data mode
  - Keyboard dialing is not supported
  - User activated remote loopback test is not supported

The baud rate depends on the setting of the speed option switches. When using ACCUNET Switched 56 kbps Digital Service, the OFF/56K must be set to 56K. All other speed switches must be set to OFF.



**NOTE:**

Only one speed selection is allowed when the OFF/ANET switch is set to ANET.

21 Data Modules

The Modular Processor Data Module (MPDM)

21-69

The Video Teleconferencing MPDM requires the following DIP switch settings for operation with ACCUNET Switched 56 kbps Digital Service or non-MPDM endpoints.

**Table 21-3. DIP Switch Settings on the Video Teleconferencing MPDM**

DIP Switch	Setting
OFF/LOW	OFF
OFF/300	OFF
OFF/1200	OFF
OFF/2400	OFF
OFF/4800	OFF
OFF/9600	OFF
OFF/19.2	OFF
OFF/56K	56K*
OFF/64K	64K*
OFF/TRBK	OFF
FDX/HDX	FDX
ASYN/SYNC	SYNC
EXT/INT	INT
OFF/DISC	OFF
OFF/KYBD	OFF
OFF/PRTY	OFF
O/EV-I/OD	ignored
OFF/DMLL	OFF†
OFF/MKBY	OFF†
OFF/ANET	ANET
OFF/SIGLS	OFF
OFF/AANS	AANS†

\* Must be set at either 56K or 64K.

† Must be set as appropriate for the installation.

## Features of the High Speed Synchronous MPDM

### Optional Interface Cards

There are two optional interface cards can be used with this MPDM package:

- V.35
  - Normal DTR operation
  - Endpoint controls (asserts) the DTR lead
- V.35 DTR
  - DTR lead on the MPDM is always high
  - Endpoint has no control over the DTR lead
  - Call is typically under PBX control, for example, permanent switched call (a DEFINITY G1 and G3) or dedicated switched call (a DEFINITY G2)

### Functional Elements

The preassembled High Speed Synchronous MPDM consists of the following parts:

- Stand-alone housing
- Modular PDM
- V.35 M1 \* (ACCUNET D-Kit)



#### NOTE:

On the front panel the data module is renamed from "MPDM" to "MPDM ACCUNET."

### Optional Settings

A new option switch, OFF/ANET, has been added, allowing the High Speed Synchronous MPDM to be optioned in two different ways:

- When the OFF/ANET switch is set to OFF, this MPDM can be optioned to function as a standard MPDM
- When the OFF/ANET switch is set to ANET, this MPDM can be optioned to be compatible with ACCUNET Switched 56 kbps Digital Service. (Set OFF/ANET to ANET for Dedicated Switch Call [DSC] arrangements.)
  - No Mode 2 handshaking required to go into data mode
  - Keyboard dialing is not supported
  - Remote loopback test is not supported



21 Data Modules

*The Modular Processor Data Module (MPDM)*

21-71

The baud rate depends on the setting of the speed option switches. When using ACCUNET Switched 56 kbps Digital Service, OFF/56K must be set to 56K. All other speed switches must be set to OFF.



**NOTE:**

Only one speed selection is allowed when the OFF/ANET switch is set to ANET.

When FDX/HDX is set to HDX (half-duplex), it can be used only on a 64 kbps facility, such as alternate voice/data trunk, PRI facility, or switched-64. (The speed can be set to 56 kbps, but requires a 64 kbps facility for proper HDX operation.)

REM/LOOP does not function when the OFF/ANET switch is set to ANET since Remote Loop requires Mode 2 handshake operation.

## MPDM PECs and Comcodes

The preassembled MPDM(s) can be ordered with the following PECs and Comcodes:

- **AUDIX/CMS MPDM**  
PEC: 2161-101  
Comcode: 106504574
- **Video Teleconferencing MPDM**  
PEC: 2161-102  
Comcode: 106504582
- **High Speed Synchronous MPDM**  
PEC: 2161-103  
Comcode: 106504590

The MPDM parts can be ordered using the following PECs and Comcodes:

- **Modular MPDM main circuit card**  
PEC: 2161-PDM  
Comcode: 103954541
- **Stand-alone housing**  
PEC: 21702  
Comcode: 103954863
- **RS-232C interface card**  
PEC: 21611  
Comcode: 103954558
- **RS-449 interface card**  
PEC: 21612  
Comcode: 103954566
- **V.35 interface card**  
PEC: 21613  
Comcode: 103954574

21 Data Modules

*The Modular Processor Data Module (MPDM)*

21-72

- **RS-366 ACU interface card**  
PEC: 21614  
Comcode: 103954582
- **V.35 DTR interface card** (This card has DTR always on.)  
PEC: 21615  
Comcode: 105218101
- **V.35 M1 \* ACCUNET D-Kit** (used to support communications over DS1-robbed bit and ACCUNET facilities)  
PEC: 21616  
Comcode: 105040141
- **71A multiple mounting**  
PEC: 21711  
Comcode: 103872149

## Additional Documents

The following documents contain additional information relating to the MPDM:

- *Modular Processor Data Module User's Guide, 999-700-300IS*
- *DEFINITY Communications System Generic 1 and Generic 2, System 75, and System 85 Terminals and Adjuncts Installation and Test, 555-015-104*

## The Modular Trunk Data Module (MTDM)

---

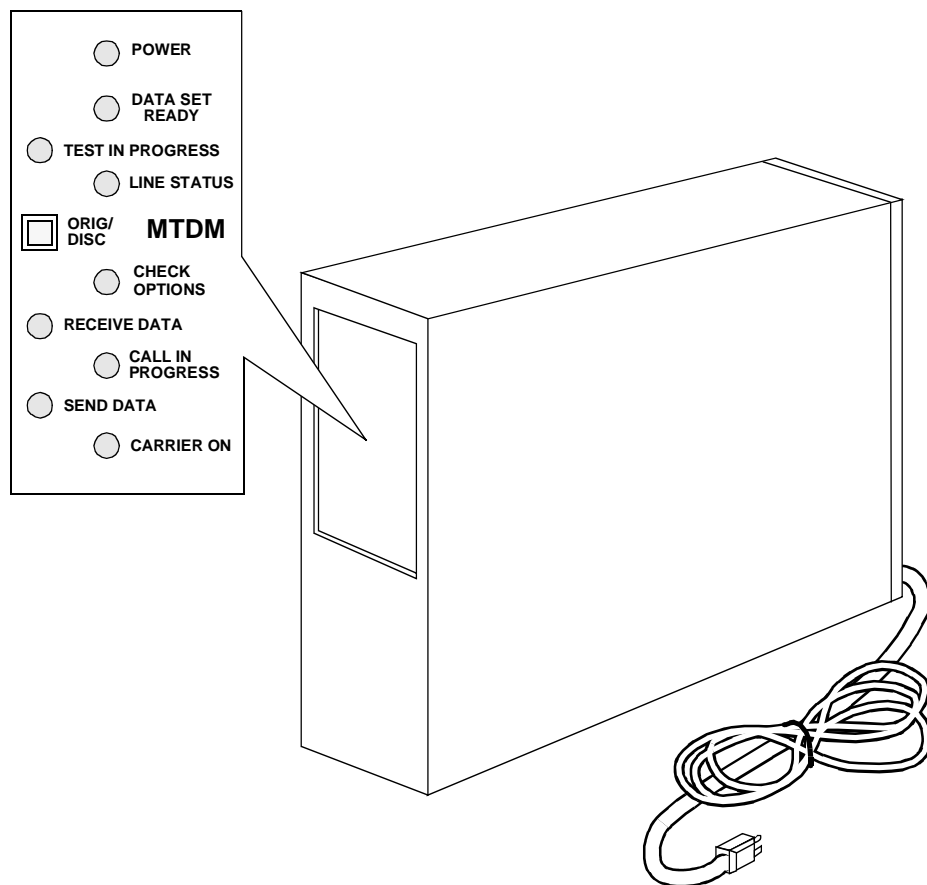

Figure 21-22. The Modular Trunk Data Module, the Stand-alone Model

Similar in appearance and function to the TDM, the MTDM is a multi-purpose data module configured to provide the digital switch interface to off-premises private line trunk facilities or a switch network telecommunications network. Similar in appearance and function to the TDM, the MTDM is a multi-purpose data module configured to provide the digital switch interface to off-premises private line trunk facilities or a switched network telecommunications network. The MTDM may also serve as a conversion resource for modem pooling.

## 21 Data Modules

### *The Modular Trunk Data Module (MTDM)*

21-74

The MTDM can be configured to support the Data Call Setup, Modem Pooling, or Off-Premises Data-Only Extensions features. In addition to the standard data transmission rates supported by previous versions of the TDM (0.3, 1.2, 2.4, 4.8, 9.6, and 19.2 kbps), the MTDM supports data rates of 56 and 64 kbps for downloading and other high speed data transfer requirements.

## Physical Description

---

### Features

#### Functional elements

- Main module — Comes in one version that is common to all modular modules and provides the basic digital interface and protocol conversion functions.
- Interface module — Provides an RS-232-C interface

#### Switches

The MTDM is equipped with the following switches:

- ORIG/DISC — This switch is located on the front panel. It is used when originating and disconnecting from a call for test purposes.
- Self-Test — This switch is located behind the front faceplate. Pressing this button performs the self-test.
- LOC LOOP/REM LOOP — This switch is located behind the faceplate. It is used to perform the Local loop test or Remote loop test.
- Options — The option switches are located behind the front faceplate. There are two Dual In-line Package switches, one a 10-position, the other a 12-position, located behind the front faceplate. Nineteen of the switches are used to set the options. The other three are spares reserved for future use.

#### Lights

The MTDM is equipped with the following lights:

- Power
- Data Set Ready
- Line Status
- Call in Progress
- Carrier on
- Test in Progress
- Check option
- Test Result

## 21 Data Modules

### *The Modular Trunk Data Module (MTDM)*

21-75

- Send Data
- Receive Data

## Other Physical Features

### Mounting Options

The MTDM can be configured either in a stand-alone or a multiple mounted version. The stand-alone version is contained in a 70A Data Mounting aluminum housing that is equipped with plastic front and rear covers. A maximum of eight MTDMs may be installed in the 71A Data Mounting.

The stand-alone version can be mounted on a surface or desk top near the associated data equipment. The multiple-mounting carrier unit is normally installed in an auxiliary cabinet.

## Capabilities

---

The MTDM offers the following features and capabilities:

- Selected rates up to 64 kbps
- Asynchronous rates up to 19.2 kbps
- Synchronous operation at 56 kbps and 64 kbps
- Full- or half-duplex operation up to 56 kbps
- Full-duplex at 64 kbps
- Self-test
- Automatic answer
- Private line and switched modes

## Power

---

Both mounting arrangements require power from a 115-volt AC receptacle to power the MTDM.

## MTDM Equipment PECs

---

The MTDM can be ordered using the following PECs:

- MTDM — 2162TDM
- RS232C Interface card — 21621
- Stand-alone housing — 21702
- 71A Multiple mount — 21711

**21 Data Modules**

*The Modular Trunk Data Module (MTDM)*

21-76

## **Additional Documents**

---

The following documents contain additional information relating to the MTDM:

- *Modular Trunk Data Module User's Guide, 999-700-301*
- *DEFINITY Generic 1 and Generic 2, System 75, and System 85 Terminals and Adjuncts Installation and Test, 555-015-104*

## The 3270 Data Module

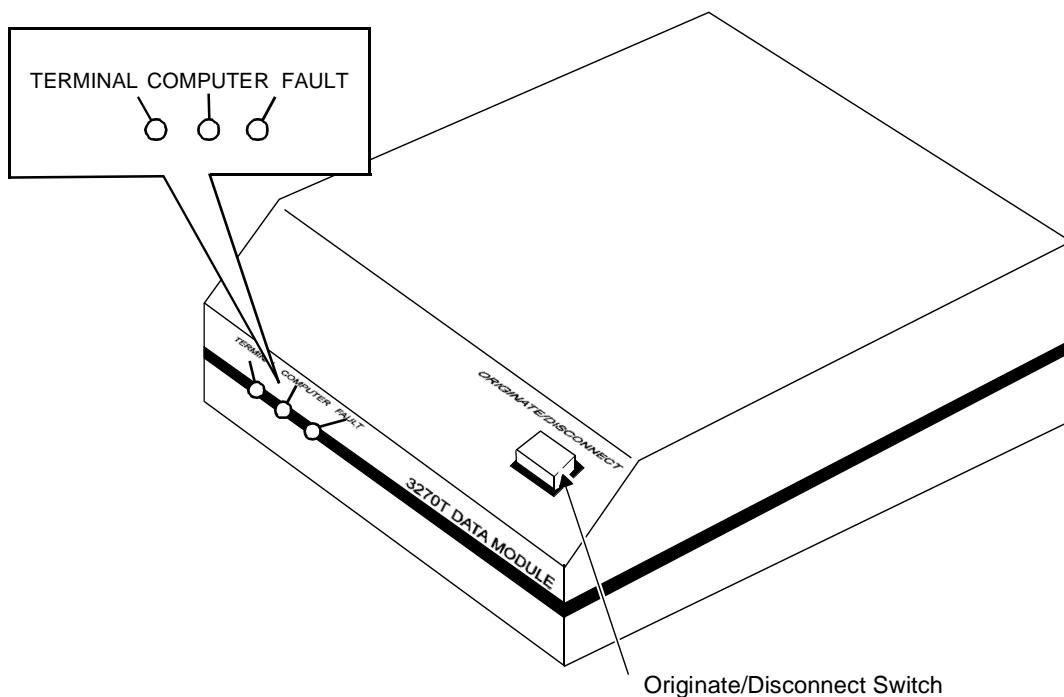

Figure 21-23. The 3270A or 3270T Data Module

The 3270 Data Module provides a Category A coaxial DCE interface for connection to 3270-type data terminals or a cluster controller. It also provides a DCP interface for connection to the digital switch.

The 3270 Data Module is available in the following three models:

- 3270T (Terminal) — Connects to a Category A 3270-type terminal, such as the IBM 3278 Information Delivery System. The 3270T Data Module must connect through the switch to a 3270C (Controller) Data Module.
- 3270A (Asynchronous) — Provides the same function as the 3270T Data Module. It also allows the 3270-type terminal to emulate a DEC VT100 or Lucent Technologies' asynchronous terminal.
- 3270C (Controller) — Connects an IBM 3274 or 3276 cluster controller to the switch. A 3270C Data Module (See Figure 21-24) can contain as many as eight ports.

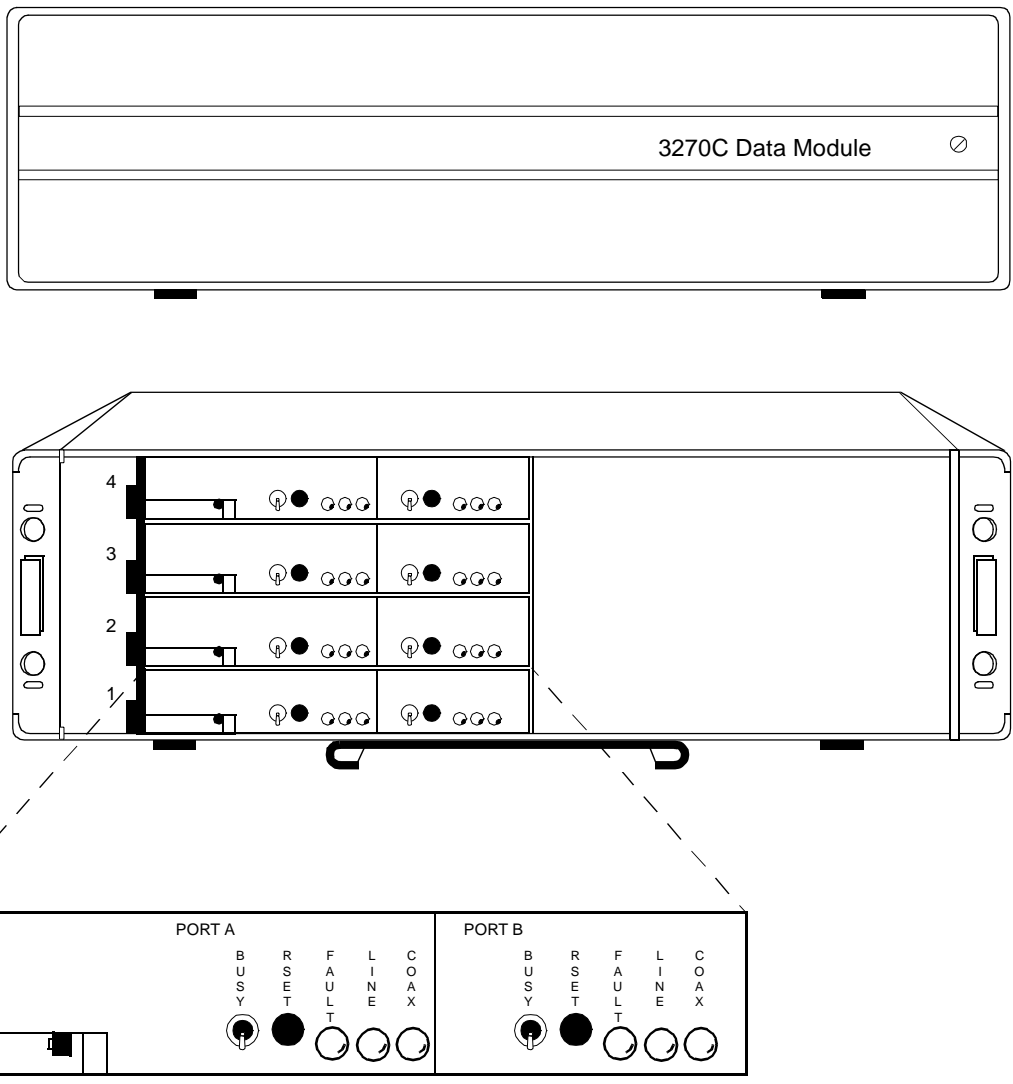

Figure 21-24. The 3270C Data Module



## **The 3270A and 3270T**

---

### **Dimensions**



**NOTE:**

The following dimensions are approximate.

Width = 5-3/4 inches

Depth (front to back) = 9-1/4 inches

Height = 1-1/2 inches

### **Lights**

The following is a list of the lights on the 3270A and 3270T.

- Terminal
- Computer
- Fault

### **Switches**

The 3270A and 3270T have the following switches:

- Orig/Disc — located on the front
- Reset — located on the rear

### **Connectors**

The 3270A and 3270T have the following connectors:

- Power
- Terminal
- Aux Phone
- Wall Jack

### **Mounting Options**

The 3270A and 3270T are desk mounted near the terminal with which it is used.

**21** Data Modules

*The 3270 Data Module*

21-80

## Cords

A D8W-87 cord is provided with the data module. The coaxial cable with BNC male connectors for use between the data module and the terminal is customer provided. If an analog telephone is to be connected, the required modular cord must be provided with the telephone.

## Power

An external power supply and the required cord is provided with the data module. The power supply requires a 115-volt AC wall receptacle not under the control of a wall switch.

## The 3270C

---

## Dimensions



**NOTE:**

The following dimensions are approximate.

Width = 19 inches

Depth (front to back) = 16-1/2 inches

Height = 5-3/4 inches

## Lights

There are two sets of the following lights on the front panel of the data module:

- Coax
- Line
- Fault

## Switches

There are two sets of the following lights on the front panel of the data module:

- Busy
- Reset

**21** Data Modules

*The 3270 Data Module*

21-81

## Connectors

The 3270 has the following connectors:

- Power
- DCP
- Port — The port connectors are labeled 1A, 2A, 3A, 4A, 1A, 1B, 1C, and 1D.

## Mounting Options

The data module assembly may be stacked, wall mounted, or rack mounted near the cluster controller to which it is connected.

## Cords

A 7-1/2 foot AC power cord is provided with the unit. A 25-pair cable for the connection to the DCP connector must be ordered separately. The coaxial cable with BNC connectors for connection to the cluster controller must be provided by the customer.

## Power

All of the mounting arrangements require power from a 115-volt AC receptacle to power the data module.

## 3270 Equipment PECs

The 3270 Data Modules can be ordered using the following PECs:

- 3270A Data Module — 2168-A10 (not orderable)
- 3270T Data Module — 2167-T10 (not orderable)
- 3270C Data Module — 2166-C10
- 3270C Data Module Circuit Card — 21660

## Additional Documents

The following documents contain additional information relating to the 3270 data module:

- *3270 Data Module User Manual*, 555-030-701
- *DEFINITY Generic 1 and Generic 2, System 75, and System 85 Terminals and Adjuncts Installation and Test*, 555-015-104

## The Asynchronous Data Unit (ADU)

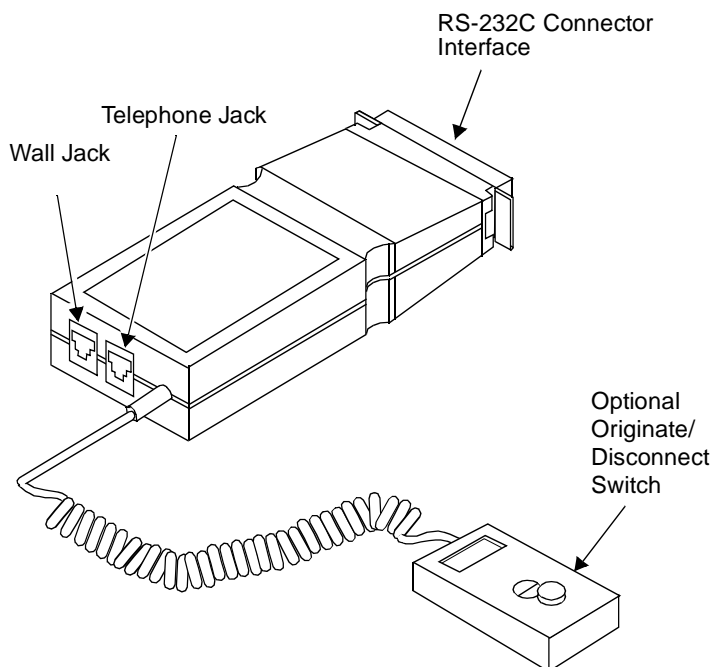

Figure 21-25. The Z3A Asynchronous Data Unit

The Z3A ADU is a small DCE-type limited-distance modem that allows direct connection between RS-232 equipment and the system digital switch. The Z3A ADU is a small DCE-type limited-distance modem that allows direct connection between RS-232 equipment and the system digital switch. Used in conjunction with the Data Line circuit pack (System 75 or a DEFINITY Communications System Generic 1 and Generic 2) or the EIA Port circuit pack (System 85), the ADU completes the direct link between the system switch and EIA terminals, printers, and host computer ports. In these applications, DTE devices can access the switch without using a separate data module or modem. The ADU is installed at the device end of the EIA connection. ADUs can also be hard-wired in pairs with other ADUs to interface data terminals directly to a host computer. This application is typical when access to the host is not made through the system.

21 Data Modules

*The Asynchronous Data Unit (ADU)*

21-83

## Physical Description

---

### Dimensions



**NOTE:**

The following dimensions are approximate.

Width = 2-1/4 inches

Depth = 4-3/4 inches

Height = 1 inch

### Features

#### Switch

An optional Originate/Disconnect switch can be used with the Z3A1, Z3A2, and Z3A4 ADUs.

### Other Physical Features

#### Jacks

The ADU has the following jacks:

- Originate/Disconnect

The Z3A1/2/4 are equipped with a jack used to connect the optional Originate/Disconnect switch.

- Telephone

The Z3A1/2/4 are equipped with modular jack to connect the optional analog telephone.

- Data and RS-232 connections

**21** Data Modules*The Asynchronous Data Unit (ADU)*

21-84

Refer to the following table for the different data and RS-232 connections.

**Table 21-4. Data Connections for the ADU**

ADU Model	Connector to RS-232	Data Connector
Z3A1	25-pin plug on 3-foot cable	Modular
Z3A2	25-pin plug (no cable)	Modular
Z3A3	110-type patch cord	110-type patch cord
Z3A4	25-pin receptacle on 3-foot cable	Modular

**Capabilities**

The ADU has the following data capabilities.

- Speed — Standard data rates from 0.3 to 19.2 kbps and non standard data rates below 1.8 kbps. The auto adjust option will automatically match the transmission speed to the attached RS-232.
- Full-duplex
- Asynchronous
- Built-in protection against voltage surges

**Power**

Under certain conditions the ADU is powered by the attached RS-232 equipment. When the power provided by the RS-232 is inadequate ( $\pm 7$  volts are required on pins 20 and 2), an external power transformer, adapter, and patch cord are required.

**21** Data Modules

*The Asynchronous Data Unit (ADU)*

21-85

## **Z3A Data Module PECs**

---

The Z3A Data Module and optional components can be ordered with the following PECs:

- Z3A1 Asynchronous Data Module — 2169-001
- Z3A2 Asynchronous Data Module — 2169-002
- Z3A3 Asynchronous Data Module — 2169-003
- Z3A4 Asynchronous Data Module — 2169-004
- Originate/Disconnect Switch — 21692
- ADM Mounting Trough — 21693

## **Additional Documents**

---

The following document contains information relating to the Z3A Data Module:

- *Asynchronous Data Unit Z3A User's Manual, 555-401-701*

## The Multiple Asynchronous Data Unit (MADU)

---

The MADU provides an RS-232-C compatible, full-duplex, asynchronous data interface which provides host computer access for a variety of DTE devices. The MADU converts information sent to it from a host computer in RS-232-C protocol to low-voltage signals. These signals can be transmitted over standard building wiring or to the switch over much greater distances than regular EIA signals may travel. The host computer is set up to appear as a DCE device to the MADU. The MADU sends the converted information out through its building wiring interface.

### Capabilities

---

The MADU has the following data capabilities.

- Speed — Standard data rates from 0.3 to 19.2 kbps and nonstandard data rates below 1.8 kbps. The auto adjust option will automatically match the transmission speed to the attached RS-232-C device.
- Full-duplex
- Asynchronous
- Built in protection against voltage surges

### Physical Description

---

#### Dimensions — stand-alone housing



**NOTE:**

The following dimensions are approximate.

Width = 8-3/4 inches

Depth = 12 inches

Height = 2-3/4 inches

#### Dimensions — multiple mount carrier



**NOTE:**

The following dimensions are approximate.

Width = 17-1/2 inches

Depth = 18 inches

Height = 8-3/4 inches



21 Data Modules

*The Multiple Asynchronous Data Unit (MADU)*

21-87

## Dimensions — MADU circuit pack



**NOTE:**

The following dimensions are approximate.

Width = 1-3/4 inches

Length = 11-1/4 inches

Height = 7-3/4 inches

## Features

### Switch

Each port on each circuit pack has a MK BUSY switch on the faceplate.

Each MADU circuit pack contains a 10-position Dual In-line Package (DIP) switch to activate or disable options.

### Lights

- Red
- DTR
- Busy

### Connectors

- To Building Wiring
- Power
- To Host computer

## Other Physical Features

### Cords

A 2-pair modular power cord, two centerfeed to endfeed cables (specify male or female when ordering), and an octopus cable (specify M48C for DTE or M48G for DCE equipment) is provided with the MADU. Any other cables or adapters must be ordered separately or be provided by the customer.

### Mounting — Stand-alone

A single MADU circuit pack may be installed in a stand-alone mounting providing eight ports. The stand-alone housings can be desk mounted. If more than one stand-alone housing is provided, they may be stacked.

21 Data Modules

*The Multiple Asynchronous Data Unit (MADU)*

21-88

### Mounting — Multiple mount

The multiple-mount MADU may be rack or cabinet mounted. The MADU may be mounted in 19, 23, or 25 inch racks. If the MADU is to be mounted in a cabinet, the cabinet must be 23 or 25 inches wide to provide clearance for the cabling.

### Power

---

Each MADU circuit pack is powered from an individual transformer which is plugged into an AC power source. The transformer may be plugged directly into a wall outlet for four or fewer units. For more than four MADU packs, transformers should be plugged into a multiple-mount carrier's power distribution box or commercially available power strip with an RF filter.

### MADU Circuit Pack PECs

---

The MADU can be ordered using the following PECs:

- MADU single unit assembly — 2169-005
- MADU carrier assembly — 2169-006
- MADU circuit pack — 21694
- MADU power transformer — 21695

### Additional Documents

---

The following document contains additional information on the MADU:

- *Multiple Asynchronous Data Unit (MADU) User's Manual, 555-401-702*

## DCIU Interface Units

---

The three interface units used in a DEFINITY Communications System Generic 2 and System 85 DCIU link are the 105A Isolating Data Interface (IDI), the 48250 Local Distribution Service Unit (LDSU), and the 2500-Series Data Service Unit (DSU).

### 105A IDI

---

The IDI is a miniature connection unit for point to point, synchronous, full-duplex operation between the DCIU and an external processor. The DCIU and the external processor can be a maximum of 400 feet apart. Only one IDI is required in each DCIU link.

Some of the features of the IDI are:

- No options or adjustments
- 0.3 through 19.2 kbps
- Uses DCIU timing
- Powered from the EIA control signals

### 48250 LDSU

---

The LDSU interfaces the System 85 DCIU with an external processor. It provides the required isolation between the DCIU and the external processor. Two LDSUs per external processors are required.

Each LDSU contains:

- A transmitter with filtering and modulation — allows data transmission at speeds from 2.4 kbps up to 19.2 kbps
- A receiver with equalization, demodulation, clock recovery, and signal presence detection — accepts incoming data from a 150 ohm line
- A regulated DC power supply for the required DC voltage
- An EIA RS-232-C interface



**NOTE:**

Each LDSU requires a 120-volt AC source.

### 2500-Series DSU

---

The 2500-Series DSU can be used as a Local Area Data Set for distances over 400 feet. Refer to the 2500-Series DSU section later in this chapter of the manual for the information on the DSU.

## The 2500-Series DSU

---

The 2500-Series DSUs allow the user's computer or DTE to communicate with remotely located equipment using Digital Data Service network lines. The DSU integrates all Channel Service Unit (CSU) and DSU functions into one unit and connects between the network interface and the user's DTE.

The DSU can operate as a point-to-point Local Area Data Set (LADS). It is used when the DCIU and external processor are more than 400 feet apart. Two DSUs per external processor are required.

### Physical Description

---

The following lists describe the dimensions of the DSUs.

- Stand-alone Dimensions (approximate)

Width = 5-3/4 inches

Depth (front to back) = 9-5/8 inches

Height = 2 inches

- Multiple Mounting Dimensions (approximate)

Width = 23 inches

Depth (front to back) = 20 inches

Height = 7 inches

### Capabilities

---

The following are the data capabilities of the DSUs.

- Full-duplex
- Synchronous operation
- Asynchronous operations with certain limitations when used as a LAD
- Three color test and status LCD panel
- Multi test functions
- Two color test and Status/Fault indicator
- User selectable options

### Operating Speeds

The 2556A, 2556B, and 2556C operate at 56 kbps. The 2596A, 2596B, and 2596C have selectable subrates of 2.4, 4.8, or 9.6 kbps. When used as a LAD, they can also be optioned for 19.2 and 64 kbps operation.

**21** Data Modules

*The 2500-Series DSU*

21-91

## **Mounting**

---

The 2500-Series DSU can be stand-alone or multiple mounted. The stand-alone units can be wall or desk mounted. The multiple mounted units are mounted in a multiple-mount housing that can house up to eight DSUs.

## **Power**

---

The stand-alone units are provided with a WP90131-L2 power pack. This power pack is plugged into a 115-volt AC wall receptacle not under the control of a wall switch. The multiple-mount housing is provided with a 6-foot power cord that is plugged into a 115-volt AC wall receptacle not under control of a wall switch. Each DSU that is to be mounted into the multiple-mount housing is equipped with a WP90131-L1 power pack that is plugged into the power strip on the rear of the housing.

## **Distance Limitations**

---

The 2556A, 2556B, and 2556C DSUs may be located a maximum distance of 50 feet from the DTE. The 2596A, 2596B, and 2596C DSUs may be located a maximum distance of 100 feet from the DTE.

## **2500-Series DSU PECs**

---

The 2500-Series DSUs and optional components can be ordered using the following PECs:

- 2556A Data Service Unit — 2225-56A
- 2596A Data Service Unit — 2225-96A
- 2556B Data Service Unit — 2225-56B
- 2596B Data Service Unit — 2225-96B
- 2556C Data Service Unit — 2225-56C
- 2596C Data Service Unit — 2225-96C
- 2500-Series Multiple-Mounting Housing — 22253
- 2600-Series Multiple-Mounting Housing — 22263

## **Additional Documents**

---

The following document contains additional information relating to the 2500-Series Data Service Unit:

- *2500-Series Data Service Unit User's Manual*, 999-100-188

<b>21</b>	Data Modules	
	<i>The 2500-Series DSU</i>	21-92

## PC Platforms (PC/PBX and PC/ISDN) and Application Software

# 22

---

This section describes the devices that provide the ability to bring the PC and telephone together in a partnership of integrated voice and data. The platforms and software covered in this section are:

- PC/PBX Platform
- PC/PBX MicroChannel Architecture Platform
- PC/ISDN Platform
- PC/PBX Connection
- E78 Plus/ISDN Software

## **PC Platforms (PC/PBX and PC/ISDN)**

---

Today, professional PC users seek to realize the promise of desktop computing productivity by accessing multiple data sources — local and remote, internal and external. Lucent Technologies PC Platforms provide both a high speed connection to the PC and an open software interface for creating applications that use the connection.

### **Overview**

---

The PC platforms are “open platforms” that allow software developers to build applications that take advantage of ISDN capabilities. The three platforms (PC/PBX, PC/PBX MicroChannel Architecture, and PC/ISDN) support a common data Applications Programming Interface (API) that provides applications portability between the DCP protocol and the ISDN-BRI. The common API protects the DEFINITY switch customers who have invested in DCP while providing a large installed DCP base for third party applications as well as the growing BRI market.

### **Platforms**

---

The PC/PBX and PC/PBX MicroChannel Architecture platforms can be used with the DEFINITY Communications System Generic 1, Generic 2, and Generic 3, the DEFINITY ECS, System 75, and System 85. The PC/ISDN platform can be used with DEFINITY G2 and G3, the DEFINITY ECS, and the 5ESS (Generic 5E4.2 and 5E5) switch. The platforms are particularly useful for building applications for those users who wish to use their PCs as a terminal for a host computer or wish to have their PC communicate with other PCs.

The connection between the PC and PBX can be either:

- DCP interface — the protocol for System 75, System 85, the DEFINITY G1, G2, and G3, and the DEFINITY ECS
- ISDN Basic Rate Interface (BRI) — available with DEFINITY G2 and G3, the DEFINITY ECS, and 5ESS switch

Physically, an expansion card is inserted in the PC and connected to the PBX via unshielded twisted pair wiring. A separate card is needed for DCP and BRI. Since these cards feature a voice port, they also support integrated voice-data applications as well as data networking.



## PC/PBX and PC/PBX MicroChannel Platforms

The PC/PBX platforms provide standalone PC users with a fully integrated networking solution that brings the benefits of high-speed, error free digital communications to the desktop. The PC/PBX platform supports existing configurations in which both the voice terminal and the PC are connected to the PBX via a single DCP line.

The PC/PBX MicroChannel Architecture platform is the same as the PC/PBX platform, but is intended for use with the IBM PS/2 Model 50 and above.

### Applications

The platforms are ideal for professionals and managers who perform many different tasks during the day. The platform architecture permits different PC applications to access its resources alternatively or simultaneously. The PC/PBX Platforms support the 7400 Series voice terminals.

Potentially, a user could hold a voice conversation, be asynchronously connected to a host or PC, or conduct a 64 kbps 3270 session to a mainframe over a single twisted-pair connection. This eliminates the need for such multiple PC communications adapters as modems and coax cards.

### Capabilities

Used in conjunction with PC applications software, the PC/PBX Platform provides the hardware architecture at the desktop for:

- High-speed PC-to-PC communication
- Access to asynchronous host environments
- Access to the synchronous 3270 environment
- Advanced telephone management capabilities

The PC/PBX Platform can also run the PC/PBX Connection software for integrating voice and data applications at the desktop. Thus, the platform supports all of the following:

- Synchronous communication via 3270 emulation with file transfer capabilities
- Asynchronous communication via VT<sup>®</sup> 100, VT102, and 4410 terminal emulation at speeds up to 19.2 kbps
- Digital Multiplexed Interface (DMI) connectivity at 64 kbps
- High-speed PC-to-PC communication for error-free file transfers at speeds up to 64 kbps via such standard asynchronous file transfer protocols as XMODEM and KERMIT

**22 PC Platforms (PC/PBX and PC/ISDN) and Application Software**  
*PC Platforms (PC/PBX and PC/ISDN)*

22-4

- Advanced phone management capabilities including:
  - Incoming call identification
  - Personal directory with up to 32,000 entries
  - Keyboard dialing
  - Messaging
  - Call log and notes
  - Switch feature access
  - Multiple call appearances

### **PC/PBX PECs**

The PC/PBX platform package can be ordered using PEC 8302-101. The PC/PBX MicroChannel Architecture platform package can be ordered using PEC 8302-105.

These packages contain:

- An interface card for the PC
- System software — a device driver and hardware/software diagnostic utilities
- Installation and Reference guide

### **PC/ISDN Platform**

The PC/ISDN platform provides standalone PC users with a fully integrated network solution in an ISDN environment. Supporting the full “2B+D” BRI, the platform brings to the desktop the benefits of high-speed, error-free digital communications.

### **Applications**

The platform is ideal for professionals and managers who perform many different tasks during the day. The platform architecture permits different PC applications to access its resources alternatively or simultaneously. The PC/ISDN Platform supports the ISDN-BRI 7500 Series voice terminals.

Potentially, a user could hold a voice conversation, be asynchronously connected to a host or PC, or conduct a 64 kbps 3270 session to a mainframe over a single twisted-pair connection. This eliminates the need for such multiple PC communications adapters as modems and coax cards.

## Capabilities

Used in conjunction with PC applications software, the PC/PBX Platform provides the hardware architecture at the desktop for:

- High-speed PC-to-PC communication
- Access to asynchronous host environments
- Access to the synchronous 3270 environment
- Advanced telephone management capabilities

In addition, the PC/ISDN Platform supports the capabilities of the ISDN-BRI 7500 Series voice terminals including:

- Conference, Transfer, Hold, and Drop
- Up to 254 call appearances
- Display and light indicator control supported from the application
- On-board digital signal processing for Dual Tone Multi-Frequency (DTMF or Touch-Tone) generation

## PC/ISDN PECs

The PC/ISDN platform package can be ordered using PEC 8302-104. This package contains:

- An interface card for the PC
- System software — a device driver, downloadable firmware, and utilities
- Installation and Reference Guide

## Additional Documents

The following documents contain additional information relating to the PC platforms.

- *PC/ISDN Interface Software Developers Guide*, 555-016-103
- *PC/PBX Platform Installation and Reference*, 555-016-101
- *PC/ISDN Platform Installation and Reference*, 555-016-102

## **PC/PBX Connection**

---

The PC/PBX Connection application software offers the users of IBM compatible PCs the voice and data capabilities of a fully integrated voice and data workstation.

### **Applications**

---

The PC/PBX Connection application software can be used with the DEFINITY Communications System Generic 1, Generic 2, and Generic 3, the DEFINITY ECS, System 75, and System 85. It is particularly useful for those users who wish to use their PCs as a terminal for a host computer or wish to have their PC communicate with other PCs. It is targeted to "power" telephone users who want to eliminate many pieces of equipment from their desk.

### **Capabilities**

---

The PC/PBX Connection can be used to perform the following activities:

- Dial calls from a PC keyboard
- Use customized telephone features from a keyboard
- Set up a personal telephone directory, search the directory, and dial voice and data calls from the directory (it can contain up to 32,000 entries)
- Know when telephone messages were received, read the messages on the screen, and have the system automatically dial calls to people who have left messages
- Log all incoming and outgoing voice and data calls and recall them on the PC
- Use voice terminal and speakerphone or voice terminal with built-in speakerphone to make hands-free calls
- Use security feature to keep directory and message information private
- Use a PC as a terminal connected to a variety of host computers (synchronous and asynchronous)
- Transfer files between a PC and another PC or host computer
- Set up "script programs" to have the system perform certain data functions

Moreover, voice and data functions can be used simultaneously, and other PC applications can be run while running PC/PBX connection in the background.

## **PC/PBX PECs**

---

The PC/PBX Connection can be ordered using the following PECs:

- PC/PBX Connection Software — 1211-101
- PC/PBX Connection Hardware (PC/PBX Platform) — 8302-101
- PC/PBX Connection Hardware (PC/PBX MicroChannel Platform) — 8302-105

## **Additional Documents**

---

The following documents contain additional information relating to the PC/PBX Connection:

- *PC/PBX Connection Release 3 Documentation Set, 555-016-715*
- *PC/PBX Connection Installation and Reference, 555-016-201*
- *PC/PBX Platform Installation and Reference, 555-016-101*

## E78 Plus/ISDN Software

---

The E78 Plus/ISDN is a 3270 terminal emulation and file transfer package for micro-mainframe connectivity. However, its use in remote applications was, until recently, limited because of low-speed connections between locations. Now, used with any of the Lucent Technologies PC Platforms, E78 Plus/ISDN provides full 3270 emulation with switched connections through the DEFINITY switch using either DCP or ISDN-BRI at speeds of 64 kbps.

### Applications

---

The E78 Plus/ISDN software can be used with the DEFINITY Communications System Generic 1, Generic 2, and Generic 3, the DEFINITY ECS, System 75, System 85, and 5ESS switch. It is particularly useful for those PC users who wish to download large amounts of data stored on central site mainframes to their desktop environment for processing and/or storage. The high-speed connection permits a PC user to transfer a large file quickly from a remote mainframe. Therefore, it is possible for users to download large quantities of data for desktop processing and analysis on a daily basis.

### Physical Description

---

The E78 Plus/ISDN provides a variety of transfer programs (for example, IRMAlink FT/TSO, FT/CMS, and FT/3270) to quickly and safely transfer text and binary files. These programs offer both menu and command-line operation in all major mainframe environments.

On the host side, a Lucent Technologies 3270C Data Module must reside between the cluster controller and switch. The PC must be equipped with either PC/ISDN Platform (BRI) Release 1.0 or later or PC/PBX Platform (DCP) Release 3.01 or later software.

### Capabilities

---

The E78 Plus/ISDN software can be used to perform the following activities:

- High-speed (64 kbps) connectivity
- Eliminate the need for costly remote controllers
- Allow terminals to access applications on hosts that are not networks, thereby reducing the number of terminals required
- Transfer a large file quickly from a remote mainframe
- Integrate with PC/PBX Connection to provide simultaneous voice and data connectivity

In addition, E78 Plus/ISDN provides productivity extras professionals expect, such as:

**22** PC Platforms (PC/PBX and PC/ISDN) and Application Software  
*E78 Plus/ISDSN Software*

22-9

- **Keyboard Macros.** Frequently repeated commands and complex data strings can be stored on the keyboard. The same key can store different macros for DOS and 3270 emulation.
- **Keyboard Remap.** This utility lets the user easily modify keyboard layouts and create new ones for new applications.
- **Hot Keys.** Convenient hot keys allow the user to do things quickly — switch between PC and emulation sessions, jump to a file transfer menu, access DOS, or get help.
- **Save and Print Screens.** The user can capture screens, as needed: in a disk file, PC internal memory or at a printer.

## E78 PECs

The E78 Plus/ISDN software can be ordered using PEC 1211-102.

## Additional Documents

Documentation for this software is provided with the purchased product.

**22** PC Platforms (PC/PBX and PC/ISDN) and Application Software  
*E78 Plus/ISDSN Software*

22-10



## Blank Templates for Model Design

# 23

---

The Software Associate can use the following blank templates to create models for administering groups of terminals at a customer site. Use the following procedures for filling out these forms.

1. In each button space write the telephone number, extension, feature code, or feature to be administered on that button. Note that some of the voice terminals have double-level buttons on which you can designate two features.
2. If the model design is to be used on other voice terminals, write the Model Name at the top of the form beside **Model Name**.
3. Fill in your name by **Software Associate**.
4. Write the numbers and letters of the project code beside **Project Code**.
5. When the customer has approved the button assignments designated on the templates, have the customer sign the form beside **Customer Approval**.
6. Beside **Date**, write the date that the customer signed the form.

The following voice terminal templates are available for your use:

- 6408+
- 6408D+
- 6416D+
- 6424D+
- 7402 Plus
- 7406D

- 7406BIS
- 7406 Plus
- 7407D
- Enhanced 7407D
- 7407 Plus
- 7410D
- 7410 Plus
- 7434D
- 7444
- 8403
- 8405B and 8405B Plus
- 8405D and 8405D Plus
- 8410B
- 8410D
- 8411B
- 8411D
- 8434 and 8434DX
- 801A Expansion Module
- 602 CALLMASTER
- CALLMASTER II and III (603)
- CALLMASTER IV
- CALLMASTER VI
- ISDN 7505
- ISDN 7506
- ISDN 7507
- ISDN 8503T
- ISDN 8510T
- ISDN 8520T

MODEL NAME: \_\_\_\_\_

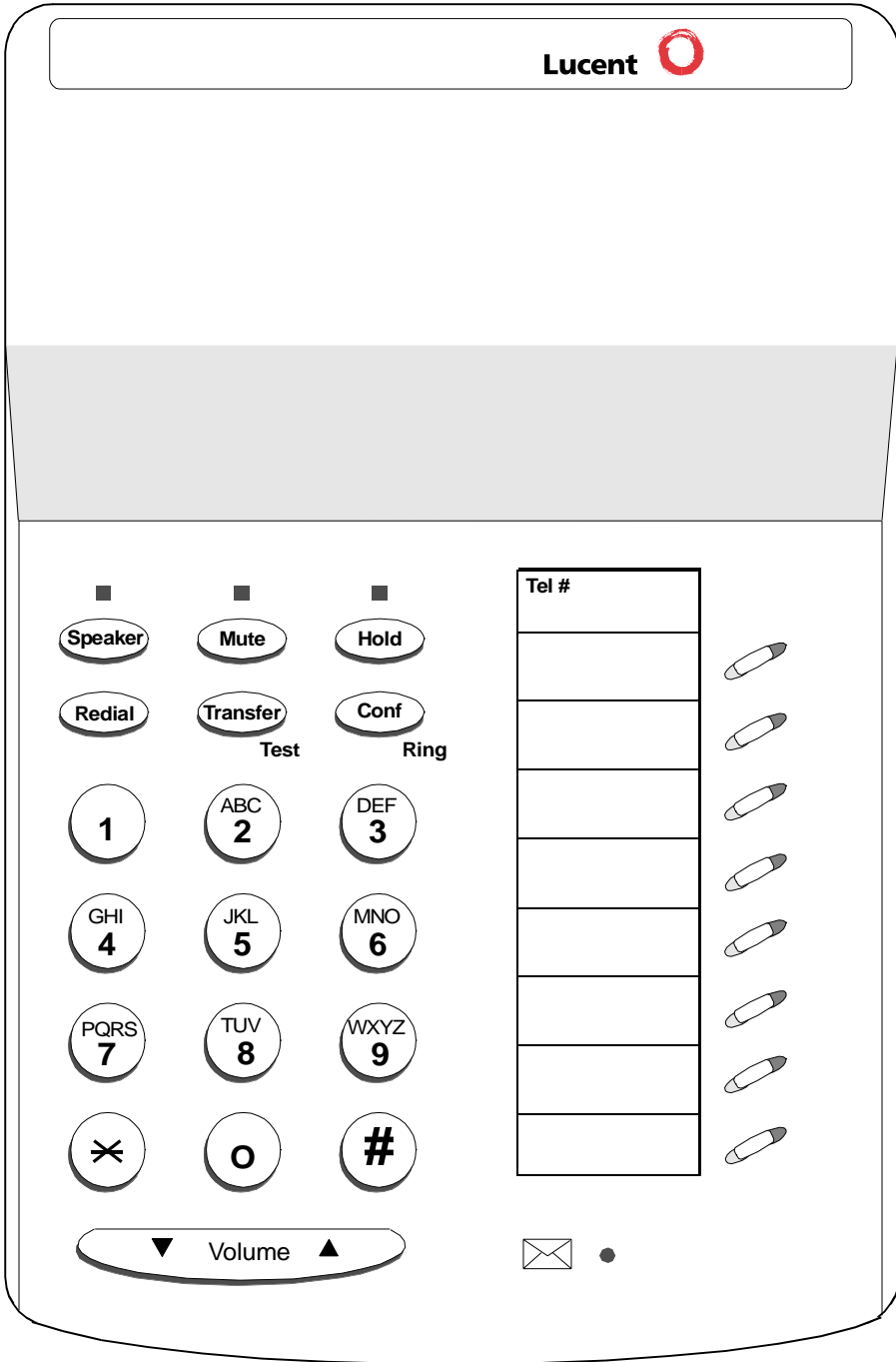

### The 6408+ Telephone

Software Associate: \_\_\_\_\_

Customer Approval: \_\_\_\_\_

Project Code: \_\_\_\_\_

Date: \_\_\_\_\_

MODEL NAME: \_\_\_\_\_

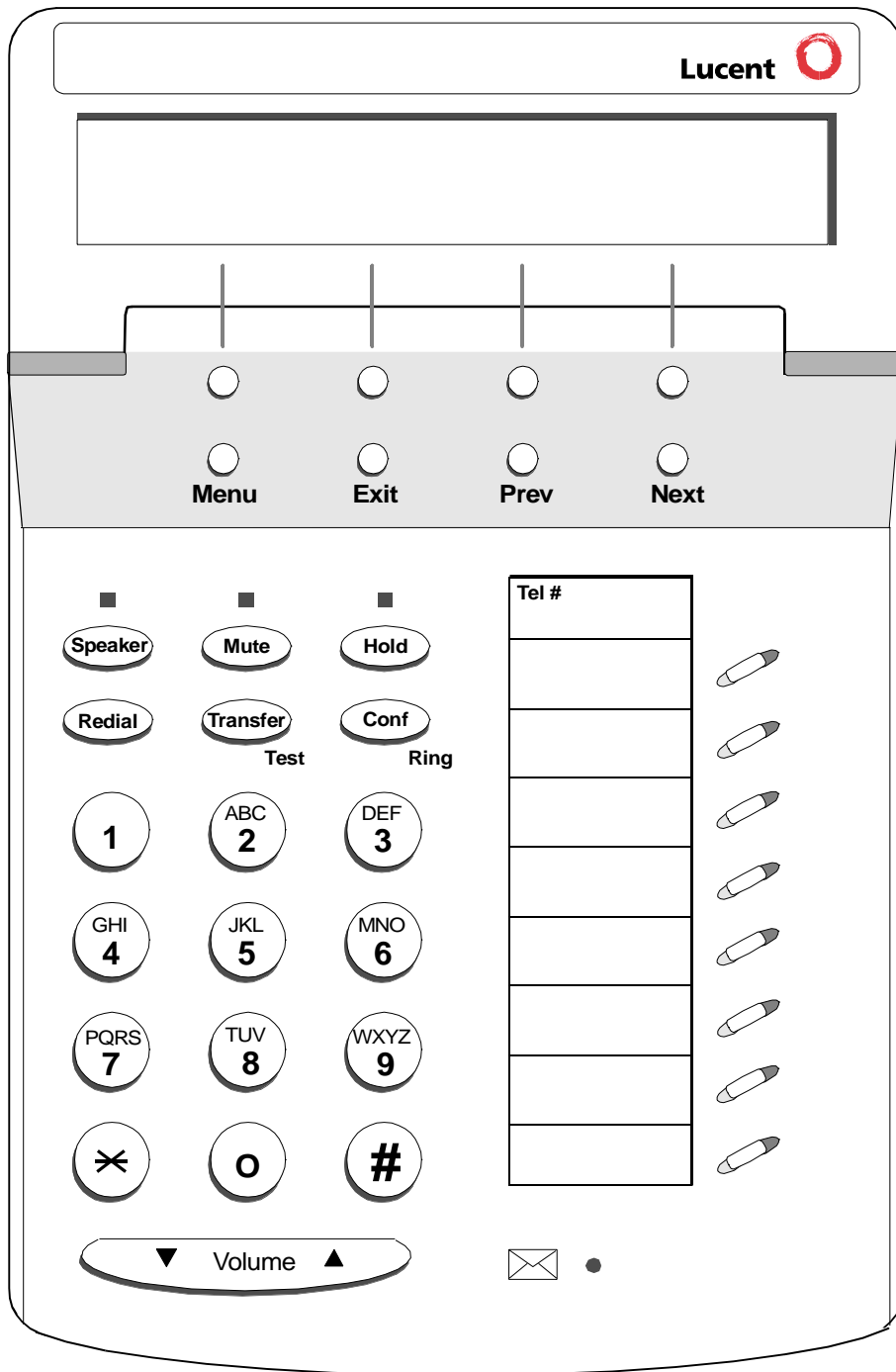

### The 6408D+ Telephone

Software Associate: \_\_\_\_\_

Customer Approval: \_\_\_\_\_

Project Code: \_\_\_\_\_

Date: \_\_\_\_\_

MODEL NAME: \_\_\_\_\_

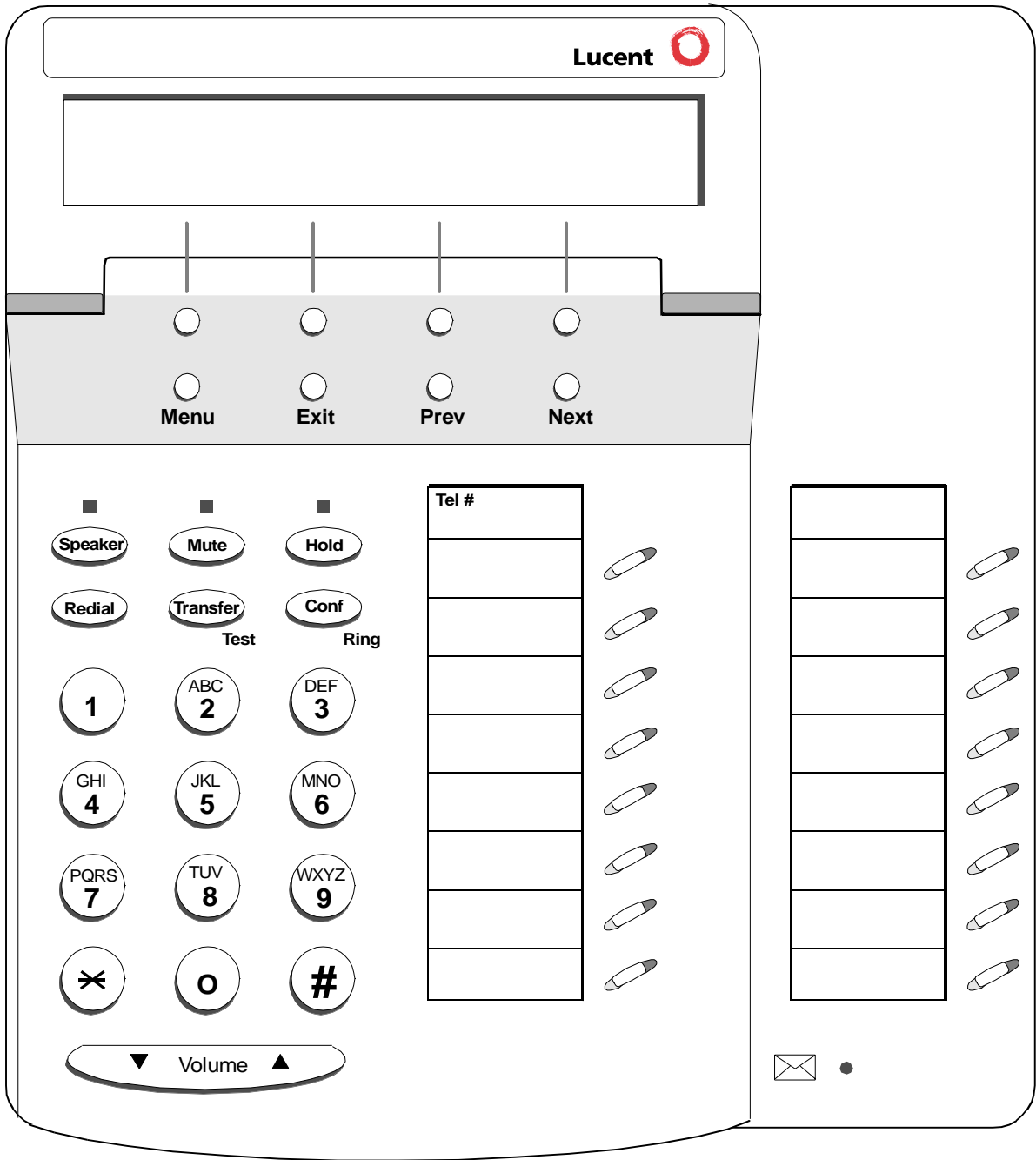

### The 6416D+ Telephone

Software Associate: \_\_\_\_\_

Customer Approval: \_\_\_\_\_

Project Code: \_\_\_\_\_

Date: \_\_\_\_\_

MODEL NAME: \_\_\_\_\_

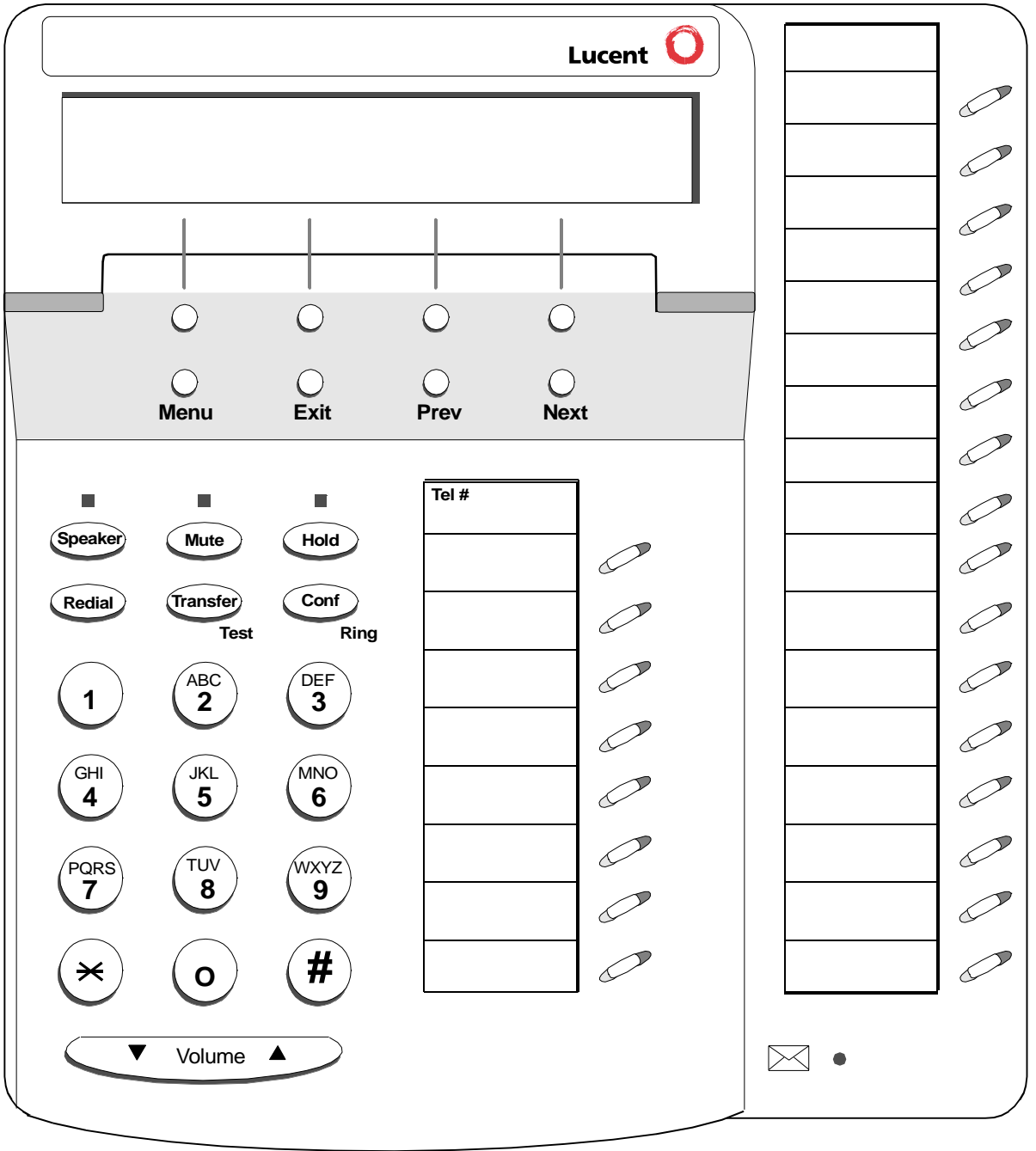

### The 6424D+ Telephone

Software Associate: \_\_\_\_\_

Customer Approval: \_\_\_\_\_

Project Code: \_\_\_\_\_

Date: \_\_\_\_\_

MODEL NAME: \_\_\_\_\_

<input type="checkbox"/>		<input checked="" type="checkbox"/>	
<input type="checkbox"/>		<input type="checkbox"/>	
<input type="checkbox"/>		<input checked="" type="checkbox"/>	
<input type="checkbox"/>		<input type="checkbox"/>	
<input checked="" type="checkbox"/>		<input checked="" type="checkbox"/>	
<input type="checkbox"/>		<input type="checkbox"/>	

<input type="checkbox"/> <i>Message</i>	<input type="checkbox"/> <input checked="" type="checkbox"/> <i>Select</i>
---	--

<i>Conference</i> <input checked="" type="checkbox"/> <i>Ring</i>	<i>Transfer</i>
--	-----------------

<i>Drop</i> <input checked="" type="checkbox"/> <i>Test</i>	<i>Hold</i>
--	-------------

<b>1</b>	<i>ABC</i> <b>2</b>	<i>DEF</i> <b>3</b>
<i>GHI</i> <b>4</b>	<i>JKL</i> <b>5</b>	<i>MNO</i> <b>6</b>
<i>PQRS</i> <b>7</b>	<i>TUV</i> <b>8</b>	<i>WXYZ</i> <b>9</b>
<b>*</b>	<i>Oper</i> <b>0</b>	<b>#</b>

<i>Speaker</i>	<input checked="" type="checkbox"/> <i>Volume</i> <input checked="" type="checkbox"/>
----------------	---

### The 7402 Plus Voice Terminal

Software Associate: \_\_\_\_\_

Customer Approval: \_\_\_\_\_

Project Code: \_\_\_\_\_

Date: \_\_\_\_\_

MODEL NAME: \_\_\_\_\_



<input type="checkbox"/>	
<input type="checkbox"/>	

<input type="checkbox"/>	
<input type="checkbox"/>	

<input type="checkbox"/>	
--------------------------	--

<input type="checkbox"/>	
<input type="checkbox"/>	

<input type="checkbox"/>	
<input type="checkbox"/>	

<input type="checkbox"/>	
--------------------------	--

<input type="checkbox"/>	
<input type="checkbox"/>	

<input type="checkbox"/>	Select Ring
<input type="checkbox"/>	

<input type="checkbox"/>	
--------------------------	--

Message

Shift

Conference

Transfer

Drop

Hold

**1**

ABC  
**2**

DEF  
**3**

GHI  
**4**

JKL  
**5**

MNO  
**6**

PRS  
**7**

TUV  
**8**

WXY  
**9**

**\***

Oper  
**0**

**#**

Speaker

### The 7406D Voice Terminal

Software Associate: \_\_\_\_\_

Customer Approval: \_\_\_\_\_

Project Code: \_\_\_\_\_

Date: \_\_\_\_\_



MODEL NAME: \_\_\_\_\_

  
  
 *Speaker*  
  
 *Mute*  
 *Select Ring*  
 *Message* *Shift*

---

---

*Conference**Transfer*

---

---

*Drop**Hold*

---

---

---

---

---

---

---

---

---

---

**1***ABC*  
**2***DEF*  
**3***GHI*  
**4***JKL*  
**5***MNO*  
**6***PRS*  
**7***TUV*  
**8***WXY*  
**9****\****Oper*  
**0****#** *Speaker Volume*

### The 7406BIS Voice Terminal

Software Associate: \_\_\_\_\_

Customer Approval: \_\_\_\_\_

Project Code: \_\_\_\_\_

Date: \_\_\_\_\_

MODEL NAME: \_\_\_\_\_



Message

Conference  
 Ring

Drop  
 Test



Select

Transfer

Hold

Speaker  
  Reset Spkr

Mute

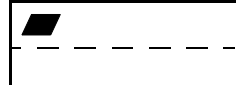
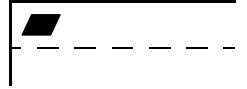
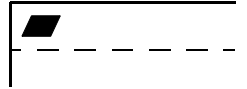
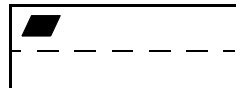
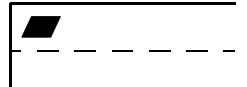
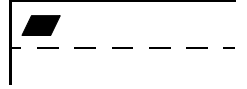

Volume

<b>1</b>	ABC <b>2</b>	DEF <b>3</b>
GHI <b>4</b>	JKL <b>5</b>	MNO <b>6</b>
PQRS <b>7</b>	TUV <b>8</b>	WXYZ <b>9</b>
<b>*</b>	Oper <b>0</b>	<b>#</b>

### The 7406 Plus Voice Terminal

Software Associate: \_\_\_\_\_

Customer Approval: \_\_\_\_\_

Project Code: \_\_\_\_\_

Date: \_\_\_\_\_

MODEL NAME: \_\_\_\_\_

<input type="checkbox"/>		<input type="checkbox"/>		<input type="checkbox"/> Conference	<input type="checkbox"/> Transfer	<input type="checkbox"/> P	
<input type="checkbox"/>		<input type="checkbox"/>		<input type="checkbox"/> Drop	<input type="checkbox"/> Hold	<input type="checkbox"/> C/ CE	
<input type="checkbox"/>		<input type="checkbox"/>				<input type="checkbox"/> M	
<input type="checkbox"/>		<input type="checkbox"/>				<input type="checkbox"/> R	
<input type="checkbox"/>		<input type="checkbox"/>				<input type="checkbox"/> M	
				<input type="checkbox"/> 1	<input type="checkbox"/> ABC 2	<input type="checkbox"/> DEF 3	
				<input type="checkbox"/> GHI 4	<input type="checkbox"/> JKL 5	<input type="checkbox"/> MNO 6	<input type="checkbox"/> M +
				<input type="checkbox"/> PRS 7	<input type="checkbox"/> TUV 8	<input type="checkbox"/> WXY 9	<input type="checkbox"/> +
<input type="checkbox"/>		<input type="checkbox"/>		<input type="checkbox"/> *	<input type="checkbox"/> Oper O	<input type="checkbox"/> #	<input type="checkbox"/> X
<input type="checkbox"/>		<input type="checkbox"/>					<input type="checkbox"/> -
<input type="checkbox"/>		<input type="checkbox"/>					<input type="checkbox"/> +
<input type="checkbox"/>		<input type="checkbox"/>		<input type="checkbox"/> Display	<input type="checkbox"/> Calculator Select Ring	<input type="checkbox"/> ✓ -	
<input type="checkbox"/> Message		<input type="checkbox"/>		<input type="checkbox"/> Speakerphone	<input type="checkbox"/> Microphone	<input type="checkbox"/> =	

### The 7407D Voice Terminal

Software Associate: \_\_\_\_\_

Customer Approval: \_\_\_\_\_

Project Code: \_\_\_\_\_

Date: \_\_\_\_\_

MODEL NAME: \_\_\_\_\_

<input type="checkbox"/>		<input type="checkbox"/>		<input type="checkbox"/> Conference	<input type="checkbox"/> Transfer		
<input type="checkbox"/>		<input type="checkbox"/>		<input type="checkbox"/> Drop	<input type="checkbox"/> Hold		
<input type="checkbox"/>		<input type="checkbox"/>					
<input type="checkbox"/>		<input type="checkbox"/>					
<input type="checkbox"/>		<input type="checkbox"/>					
<input type="checkbox"/>		<input type="checkbox"/>		<input type="checkbox"/> 1	<input type="checkbox"/> ABC 2	<input type="checkbox"/> DEF 3	
<input type="checkbox"/>		<input type="checkbox"/>		<input type="checkbox"/> GHI 4	<input type="checkbox"/> JKL 5	<input type="checkbox"/> MNO 6	
<input type="checkbox"/>		<input type="checkbox"/>		<input type="checkbox"/> PRS 7	<input type="checkbox"/> TUV 8	<input type="checkbox"/> WXY 9	
<input type="checkbox"/>		<input type="checkbox"/>		<input type="checkbox"/> *	<input type="checkbox"/> Oper O	<input type="checkbox"/> #	
<input type="checkbox"/>		<input type="checkbox"/>		<input type="checkbox"/> Message	<input type="checkbox"/> Select Ring		
<input type="checkbox"/>		<input type="checkbox"/>		<input type="checkbox"/> Speaker	<input type="checkbox"/> Mute		
<input type="checkbox"/>		<input type="checkbox"/>		<input type="checkbox"/> Volume			

### The Enhanced 7407D Voice Terminal

Software Associate: \_\_\_\_\_

Customer Approval: \_\_\_\_\_

Project Code: \_\_\_\_\_

Date: \_\_\_\_\_

MODEL NAME: \_\_\_\_\_

<input type="checkbox"/>	<input type="checkbox"/>	<input type="checkbox"/> Conference Ring	<input type="checkbox"/> Transfer		
<input type="checkbox"/>	<input type="checkbox"/>	<input type="checkbox"/> Drop Test	<input type="checkbox"/> Hold		
<input type="checkbox"/>	<input type="checkbox"/>				
<input type="checkbox"/>	<input type="checkbox"/>				
<input type="checkbox"/>	<input type="checkbox"/>	<input type="checkbox"/> 1	<input type="checkbox"/> ABC 2	<input type="checkbox"/> DEF 3	
		<input type="checkbox"/> GHI 4	<input type="checkbox"/> JKL 5	<input type="checkbox"/> MNO 6	
		<input type="checkbox"/> PQRS 7	<input type="checkbox"/> TUV 8	<input type="checkbox"/> WXYZ 9	
		<input type="checkbox"/> *	<input type="checkbox"/> Oper 0	<input type="checkbox"/> #	
<input type="checkbox"/>	<input type="checkbox"/>	<input type="checkbox"/> Message	<input type="checkbox"/> Select		
<input type="checkbox"/>	<input checked="" type="checkbox"/> Volume ^	<input type="checkbox"/> Speaker Reset/Spkr	<input type="checkbox"/> Mute		

The 7407 Plus Voice Terminal

Software Associate: \_\_\_\_\_

Customer Approval: \_\_\_\_\_

Project Code: \_\_\_\_\_

Date: \_\_\_\_\_

MODEL NAME: \_\_\_\_\_

<input type="checkbox"/>		<input type="checkbox"/>	
<input type="checkbox"/>		<input type="checkbox"/>	
<input type="checkbox"/>		<input type="checkbox"/>	
<input type="checkbox"/>		<input type="checkbox"/>	
<input type="checkbox"/>		<input type="checkbox"/>	
<i>Conference</i>		<i>Transfer</i>	
<i>Drop</i>		<i>Hold</i>	
<b>1</b>	<b>ABC</b> <b>2</b>	<b>DEF</b> <b>3</b>	
<b>GHI</b> <b>4</b>	<b>JKL</b> <b>5</b>	<b>MNO</b> <b>6</b>	
<b>PRS</b> <b>7</b>	<b>TUV</b> <b>8</b>	<b>WXY</b> <b>9</b>	
<b>*</b>	<i>Oper</i> <b>0</b>	<b>#</b>	
<input type="checkbox"/> <i>Message</i>	<input type="checkbox"/> <i>Select Ring</i>	<input type="checkbox"/>	

### The 7410D Voice Terminal

Software Associate: \_\_\_\_\_

Customer Approval: \_\_\_\_\_

Project Code: \_\_\_\_\_

Date: \_\_\_\_\_

MODEL NAME: \_\_\_\_\_

<input type="checkbox"/>		<input type="checkbox"/>	
<input type="checkbox"/>		<input type="checkbox"/>	
<input type="checkbox"/>		<input type="checkbox"/>	
<input type="checkbox"/>		<input type="checkbox"/>	
<input type="checkbox"/>		<input type="checkbox"/>	
<input type="checkbox"/>	<i>Message</i>	<input type="checkbox"/>	<input checked="" type="checkbox"/> <i>Select</i>
<i>Conference</i> <input checked="" type="checkbox"/> <i>Ring</i>		<i>Transfer</i>	
<i>Drop</i> <input checked="" type="checkbox"/> <i>Test</i>		<i>Hold</i>	
<b>1</b>	<i>ABC</i> <b>2</b>	<i>DEF</i> <b>3</b>	
<i>GHI</i> <b>4</b>	<i>JKL</i> <b>5</b>	<i>MNO</i> <b>6</b>	
<i>PQRS</i> <b>7</b>	<i>TUV</i> <b>8</b>	<i>WXYZ</i> <b>9</b>	
<b>*</b>	<i>Oper</i> <b>0</b>	<b>#</b>	
<i>Speaker</i>		<input checked="" type="checkbox"/> <i>Volume</i> <input checked="" type="checkbox"/>	

### The 7410 Plus Voice Terminal

Software Associate: \_\_\_\_\_

Customer Approval: \_\_\_\_\_

Project Code: \_\_\_\_\_

Date: \_\_\_\_\_







MODEL NAME: \_\_\_\_\_

8403

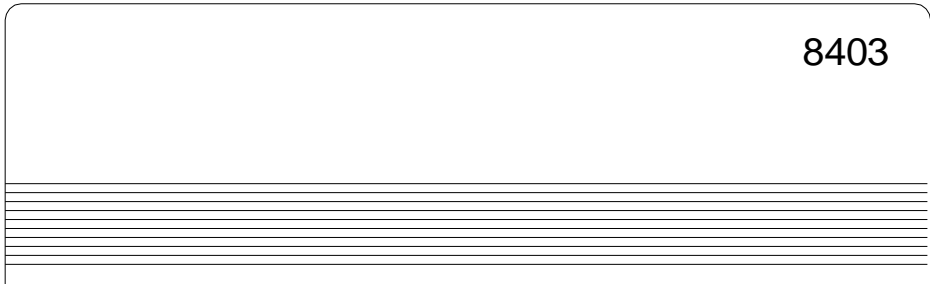

F1	F7	
F2	F8	
F3	F9	
F4	F*	
F5	F0	
F6	F#	
a	b	c
<input type="checkbox"/> <input type="checkbox"/> <input type="text"/>	<input type="checkbox"/> <input type="checkbox"/> <input type="text"/>	<input type="checkbox"/> <input type="checkbox"/> <input type="text"/>

∇ Volume ▲

Message

<input type="checkbox"/> Feature	<input type="checkbox"/> Transfer	<input type="checkbox"/> 1	<input type="checkbox"/> ABC 2	<input type="checkbox"/> DEF 3
<input type="checkbox"/> Test	<input type="checkbox"/> Conf	<input type="checkbox"/> GHI 4	<input type="checkbox"/> JKL 5	<input type="checkbox"/> MNO 6
<input type="checkbox"/> Mute	<input type="checkbox"/> Drop	<input type="checkbox"/> PQRS 7	<input type="checkbox"/> TUV 8	<input type="checkbox"/> WXYZ 9
<input type="checkbox"/> Speaker	<input type="checkbox"/> Hold	<input type="checkbox"/> *	<input type="checkbox"/> 0	<input type="checkbox"/> #

Ring

### The 8403 Voice Terminal

Software Associate: \_\_\_\_\_





Customer Approval: \_\_\_\_\_



Project Code: \_\_\_\_\_

Date: \_\_\_\_\_

MODEL NAME: \_\_\_\_\_

8405B

 <input type="checkbox"/>		
 <input type="checkbox"/>		
 <input type="checkbox"/>		
 <input type="checkbox"/>		
 <input type="checkbox"/>		

 Volume 

Shift Transfer

Test Conf

Mute Drop

Speaker Hold

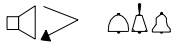

**1** ABC **2** DEF **3**

GHI **4** JKL **5** MNO **6**

PQRS **7** TUV **8** WXYZ **9**

\* **0** #

### The 8405B and 8405B Plus Voice Terminal

Software Associate: \_\_\_\_\_

Customer Approval: \_\_\_\_\_

Project Code: \_\_\_\_\_

Date: \_\_\_\_\_

MODEL NAME: \_\_\_\_\_

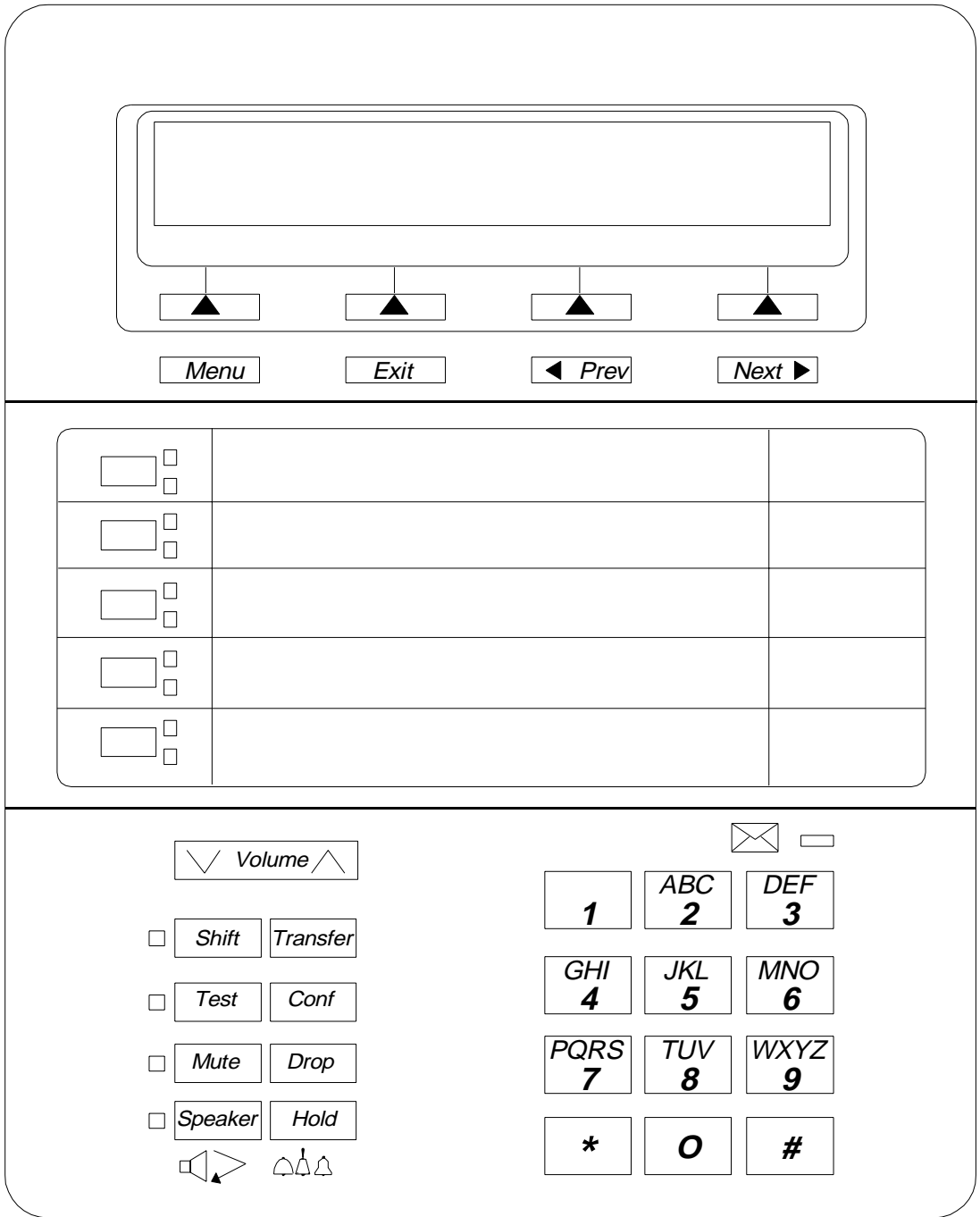

### The 8405D and 8405D Plus Voice Terminal

Software Associate: \_\_\_\_\_

Customer Approval: \_\_\_\_\_

Project Code: \_\_\_\_\_

Date: \_\_\_\_\_

MODEL NAME: \_\_\_\_\_

8410B

<input type="checkbox"/>			<input type="checkbox"/>
<input type="checkbox"/>			<input type="checkbox"/>
<input type="checkbox"/>			<input type="checkbox"/>
<input type="checkbox"/>			<input type="checkbox"/>
<input type="checkbox"/>			<input type="checkbox"/>

Volume

Message

Shift Transfer

1 ABC DEF  
 2

Test Conf

GHI JKL MNO  
 4 5 6

Mute Drop

PQRS TUV WXYZ  
 7 8 9

Speaker Hold  
Reset Spkr Ring

\* 0 #

### The 8410B Voice Terminal

Software Associate: \_\_\_\_\_

Customer Approval: \_\_\_\_\_

Project Code: \_\_\_\_\_

Date: \_\_\_\_\_

MODEL NAME: \_\_\_\_\_

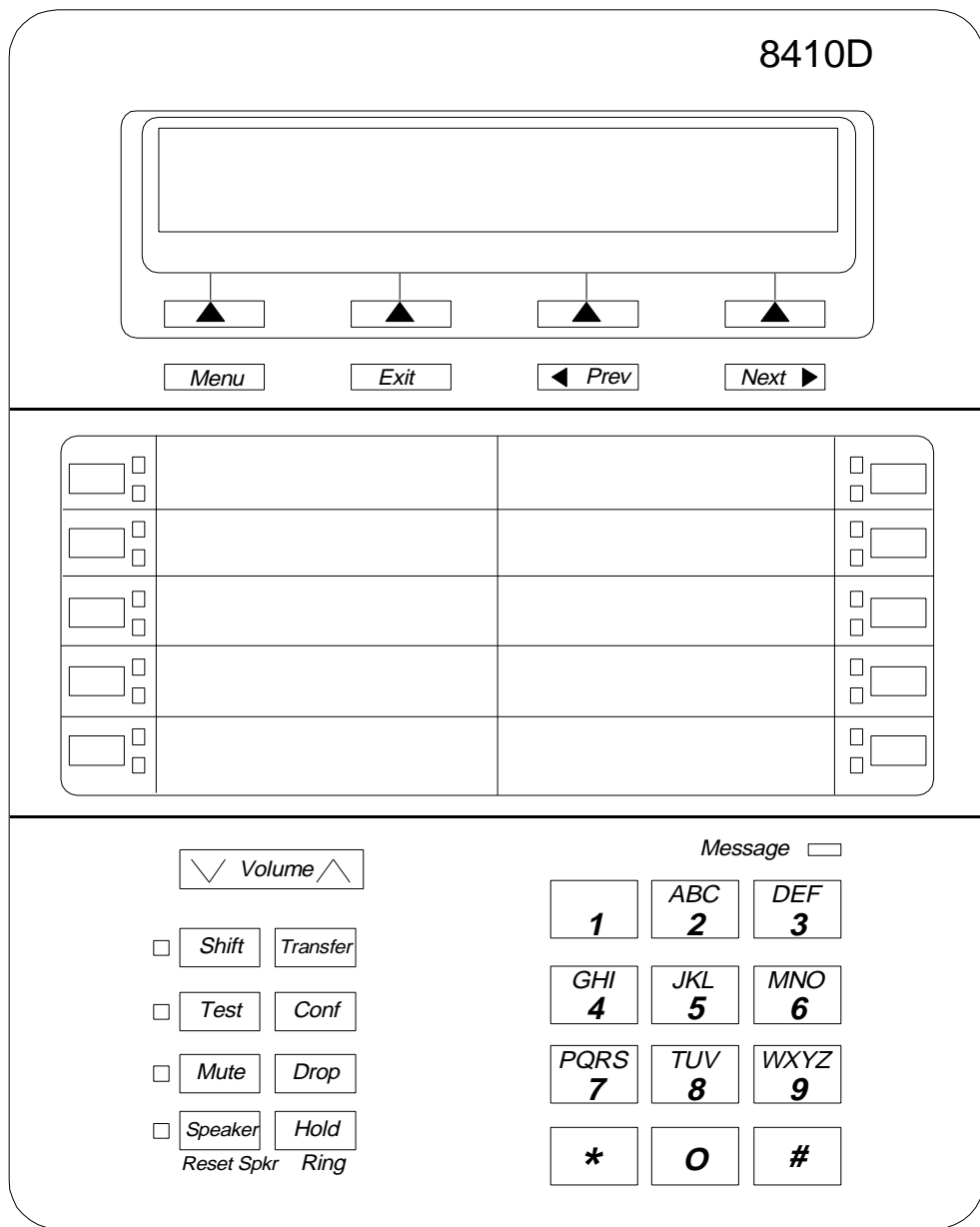

The 8410D Voice Terminal

Software Associate: \_\_\_\_\_

Customer Approval: \_\_\_\_\_

Project Code: \_\_\_\_\_

Date: \_\_\_\_\_

MODEL NAME: \_\_\_\_\_

8411B

<input type="checkbox"/> <input type="checkbox"/>			<input type="checkbox"/> <input type="checkbox"/>
<input type="checkbox"/> <input type="checkbox"/>			<input type="checkbox"/> <input type="checkbox"/>
<input type="checkbox"/> <input type="checkbox"/>			<input type="checkbox"/> <input type="checkbox"/>
<input type="checkbox"/> <input type="checkbox"/>			<input type="checkbox"/> <input type="checkbox"/>
<input type="checkbox"/> <input type="checkbox"/>			<input type="checkbox"/> <input type="checkbox"/>

Volume

Message

Shift Transfer

1 ABC DEF  
 2 3

Test Conf

GHI JKL MNO  
 4 5 6

Mute Drop

PQRS TUV WXYZ  
 7 8 9

Speaker Hold  
Reset Spkr Ring

\* 0 #

### The 8411B Voice Terminal

Software Associate: \_\_\_\_\_

Customer Approval: \_\_\_\_\_

Project Code: \_\_\_\_\_

Date: \_\_\_\_\_

MODEL NAME: \_\_\_\_\_

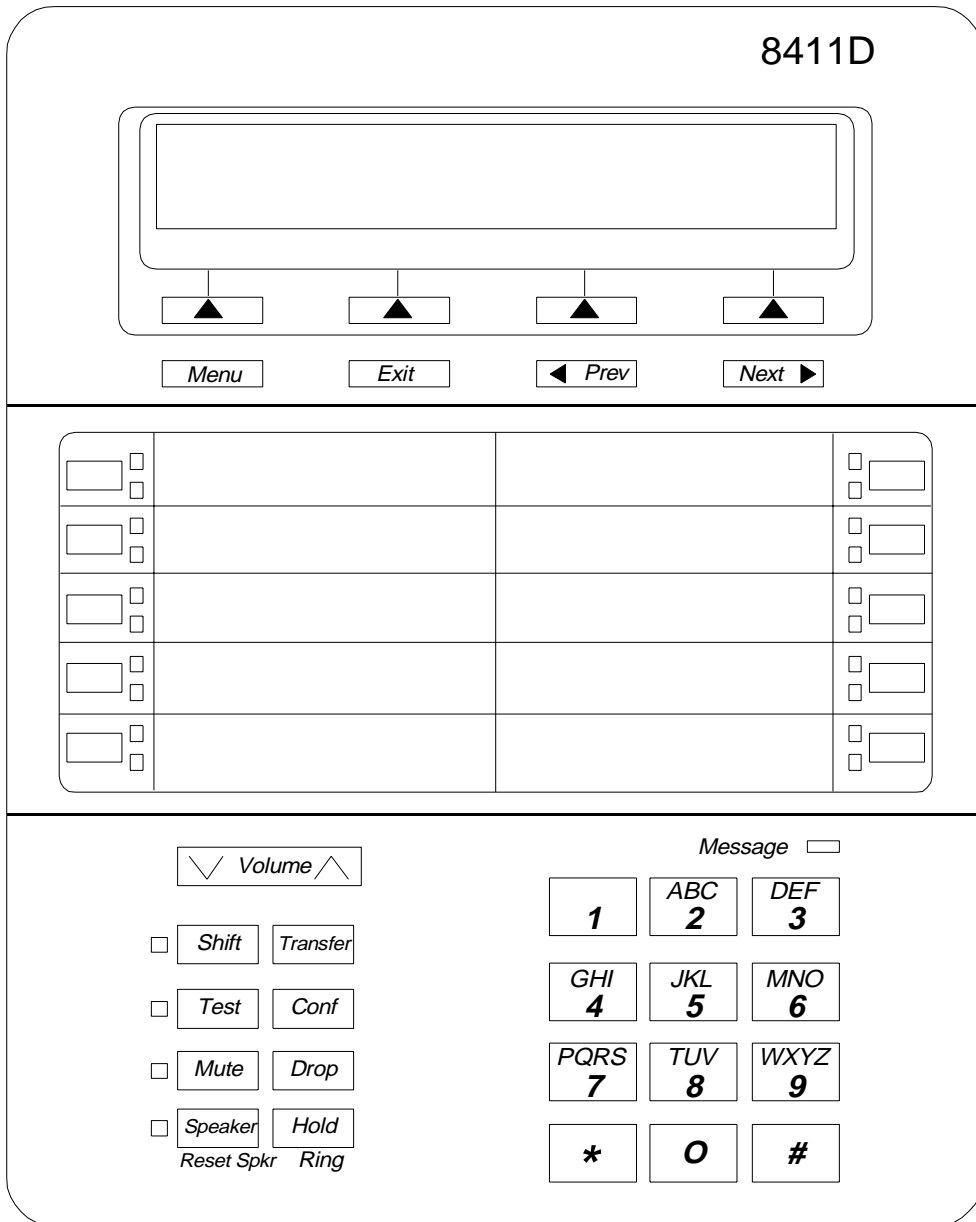

The 8411D Voice Terminal

Software Associate: \_\_\_\_\_

Customer Approval: \_\_\_\_\_

Project Code: \_\_\_\_\_

Date: \_\_\_\_\_



MODEL NAME: \_\_\_\_\_

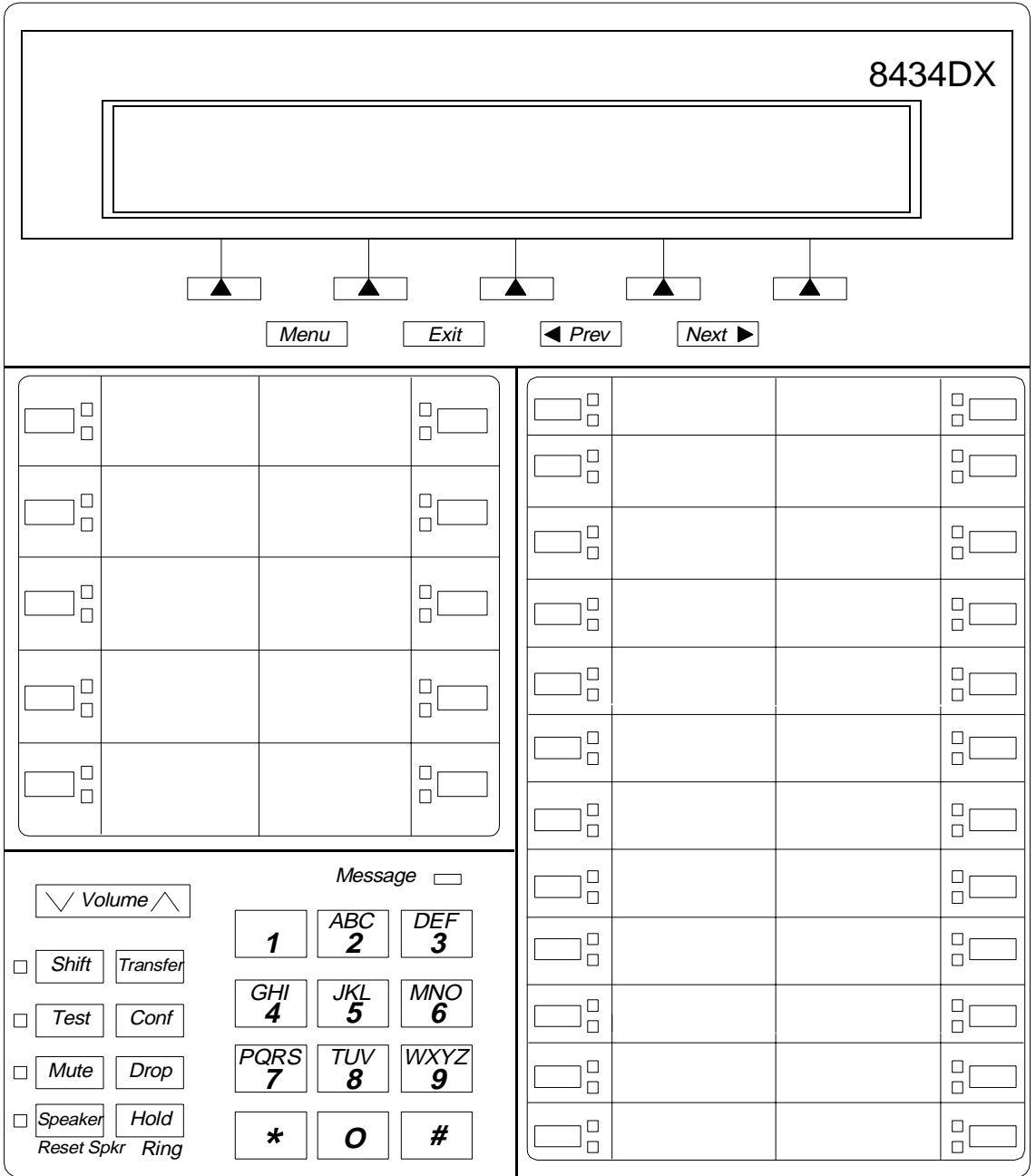

### The 8434 and 8434DX Voice Terminal

Software Associate: \_\_\_\_\_

Customer Approval: \_\_\_\_\_

Project Code: \_\_\_\_\_

Date: \_\_\_\_\_

MODEL NAME: \_\_\_\_\_

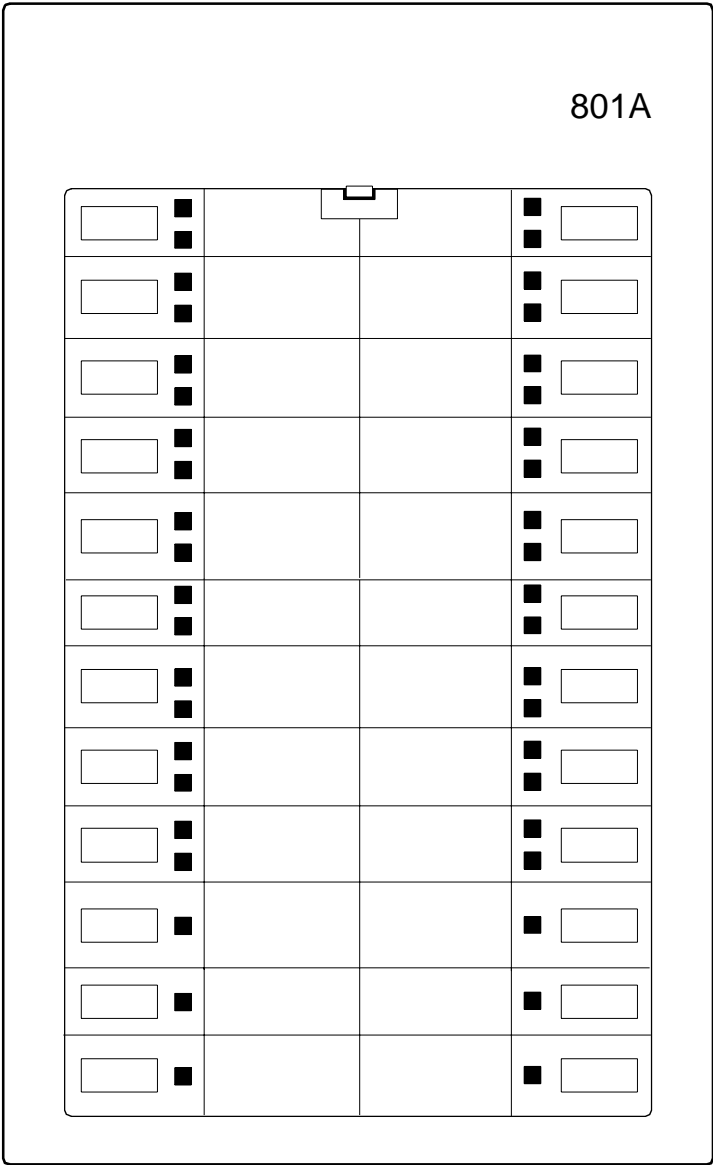

The 801A Expansion Module

Software Associate: \_\_\_\_\_

Customer Approval: \_\_\_\_\_

Project Code: \_\_\_\_\_

Date: \_\_\_\_\_









MODEL NAME: \_\_\_\_\_

<input type="checkbox"/>		<input type="checkbox"/>		<input type="checkbox"/>	
<input type="checkbox"/>		<input type="checkbox"/>		<input type="checkbox"/>	
<input type="checkbox"/>		<input type="checkbox"/>		<input type="checkbox"/>	
<input type="checkbox"/>	<i>Message</i>	<input type="checkbox"/>		<input checked="" type="checkbox"/>	
<i>Conference Ring</i>		<i>Transfer</i>		<input checked="" type="checkbox"/>	
<i>Drop Test</i>		<i>Hold</i>		<input checked="" type="checkbox"/>	
					<i>Redial</i>
					<input type="checkbox"/> <input checked="" type="checkbox"/> <i>Select</i>
					<input type="checkbox"/> <i>Mute</i>
					<input type="checkbox"/> <i>Speaker</i>
					<input checked="" type="checkbox"/> <i>Volume</i> <input checked="" type="checkbox"/>

<b>1</b>	<i>ABC</i> <b>2</b>	<i>DEF</i> <b>3</b>
<i>GHI</i> <b>4</b>	<i>JKL</i> <b>5</b>	<i>MNO</i> <b>6</b>
<i>PRS</i> <b>7</b>	<i>TUV</i> <b>8</b>	<i>WXY</i> <b>9</b>
<b>*</b>	<i>Oper</i> <b>0</b>	<b>#</b>

The ISDN 7505 Voice Terminal

Software Associate: \_\_\_\_\_

Customer Approval: \_\_\_\_\_

Project Code: \_\_\_\_\_

Date: \_\_\_\_\_

MODEL NAME: \_\_\_\_\_

<input type="checkbox"/>		<input type="checkbox"/>		<input type="checkbox"/>	
<input type="checkbox"/>		<input type="checkbox"/>		<input type="checkbox"/>	
<input type="checkbox"/>		<input type="checkbox"/>		<input type="checkbox"/>	
<input type="checkbox"/>	Message	<input type="checkbox"/>	Data/Send/Off	<input checked="" type="checkbox"/>	
<u>Conference Ring</u>		<u>Transfer Clock</u>		<input checked="" type="checkbox"/>	
<u>Drop Test</u>		<u>Hold</u>		<input checked="" type="checkbox"/>	
					<u>Redial</u>
					<input type="checkbox"/> <input checked="" type="checkbox"/> Select
					<input type="checkbox"/> Mute
					<input type="checkbox"/> Speaker
					<input checked="" type="checkbox"/> Volume <input checked="" type="checkbox"/>

<b>1</b>	ABC <b>2</b>	DEF <b>3</b>
GHI <b>4</b>	JKL <b>5</b>	MNO <b>6</b>
PRS <b>7</b>	TUV <b>8</b>	WXY <b>9</b>
*	Oper <b>0</b>	#

The ISDN 7506 Voice Terminal

Software Associate: \_\_\_\_\_

Customer Approval: \_\_\_\_\_

Project Code: \_\_\_\_\_

Date: \_\_\_\_\_





MODEL NAME: \_\_\_\_\_

<input type="checkbox"/>		
<i>Press <b>Memory</b> button, then dialpad button</i>		
<b>1</b>	<b>5</b>	<b>9</b>
<b>2</b>	<b>6</b>	<b>0</b>
<b>3</b>	<b>7</b>	<b>*</b>
<b>4</b>	<b>8</b>	<b>#</b>
<b>a</b>	<b>b</b>	<b>c</b>
<input type="checkbox"/> <input type="checkbox"/>	<input type="checkbox"/> <input type="checkbox"/>	<input type="checkbox"/> <input type="checkbox"/>

<input type="checkbox"/> <b>Volume</b> <input type="checkbox"/>				
<i>Message</i> <input type="checkbox"/>				
<input type="checkbox"/> <b>Mute</b>	<input type="checkbox"/> <b>Redial</b>	<b>1</b>	<b>ABC</b> <b>2</b>	<b>DEF</b> <b>3</b>
<input type="checkbox"/> <b>Program</b>	<input type="checkbox"/> <b>Memory</b>	<b>GHI</b> <b>4</b>	<b>JKL</b> <b>5</b>	<b>MNO</b> <b>6</b>
<input type="checkbox"/> <b>Conf</b> <u>Ring</u>	<input type="checkbox"/> <b>Drop</b> <u>Test</u>	<b>PQRS</b> <b>7</b>	<b>TUV</b> <b>8</b>	<b>WXYZ</b> <b>9</b>
<input type="checkbox"/> <b>Transfer</b> <u>Pause</u>	<input type="checkbox"/> <b>Hold</b>	<b>*</b>	<b>OPER</b> <b>0</b>	<b>#</b>

The ISDN 8503T Voice Terminal

Software Associate: \_\_\_\_\_

Customer Approval: \_\_\_\_\_

Project Code: \_\_\_\_\_

Date: \_\_\_\_\_

MODEL NAME: \_\_\_\_\_

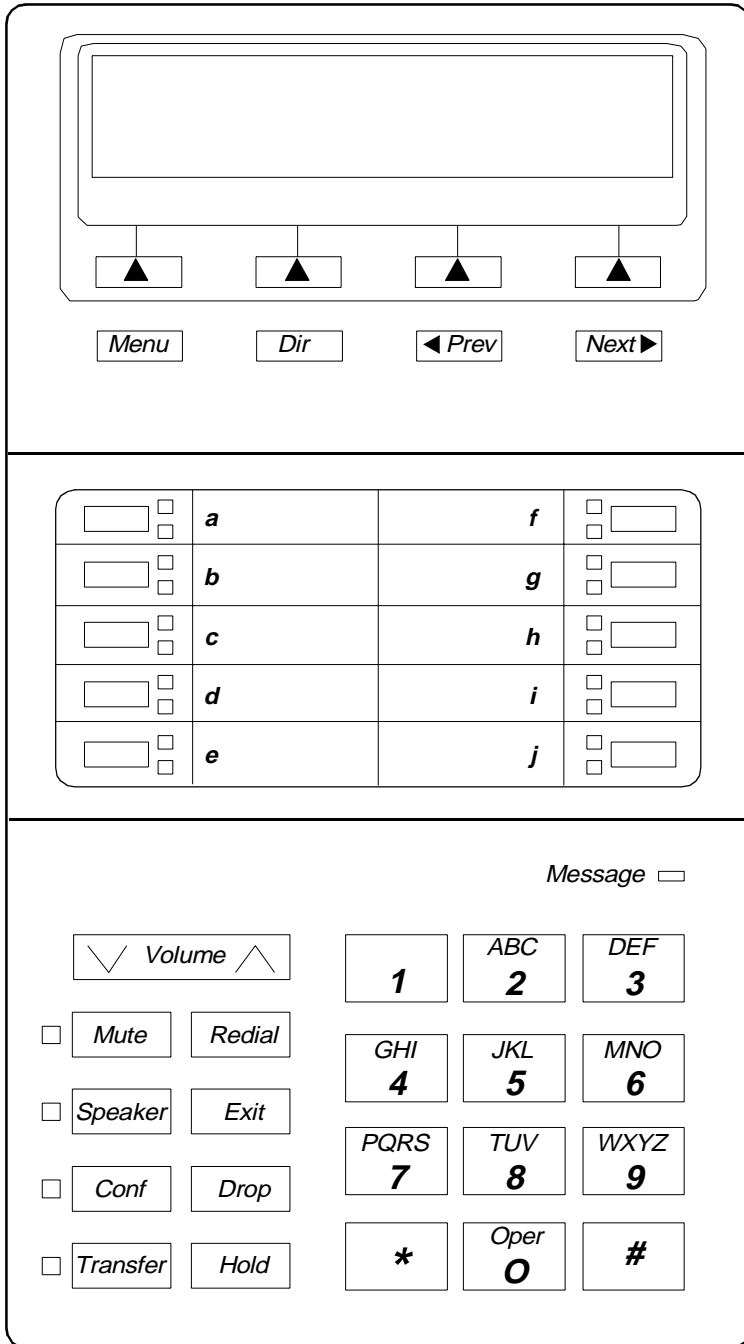

### The ISDN 8510T Voice Terminal

Software Associate: \_\_\_\_\_

Customer Approval: \_\_\_\_\_

Project Code: \_\_\_\_\_

Date: \_\_\_\_\_

MODEL NAME: \_\_\_\_\_

# ISDN 8520T

<input type="text"/>	<b>a</b>	<b>f</b>	<input type="text"/>	<b>k</b>	<b>p</b>	<input type="text"/>
<input type="text"/>	<b>b</b>	<b>g</b>	<input type="text"/>	<b>l</b>	<b>q</b>	<input type="text"/>
<input type="text"/>	<b>c</b>	<b>h</b>	<input type="text"/>	<b>m</b>	<b>r</b>	<input type="text"/>
<input type="text"/>	<b>d</b>	<b>i</b>	<input type="text"/>	<b>n</b>	<b>s</b>	<input type="text"/>
<input type="text"/>	<b>e</b>	<b>j</b>	<input type="text"/>	<b>o</b>	<b>t</b>	<input type="text"/>

**Message**

## The ISDN 8520T Voice Terminal

Software Associate: \_\_\_\_\_

Customer Approval: \_\_\_\_\_

Project Code: \_\_\_\_\_

Date: \_\_\_\_\_